



OGE
ORTHOGENT
ENGINEERING

05

CONTENTS	PAGE
Scissors	01 - 22
Thumb Forceps	23 - 36
Needle Holders, Haemostatic Forceps & Clamps	37 - 90
Cardiovascular	91 - 118
Micro Surgery	119 - 134
Rib Shears, Spreaders & Contractors	135 - 150
General Abdominal Surgery & Gynecology	151 - 180
Scalpels	181 - 192
Sterilization	193 - 204
Index	205 - 209

Scissors



OGE
ORTHOGENT
ENGINEERING

GOLD LINE

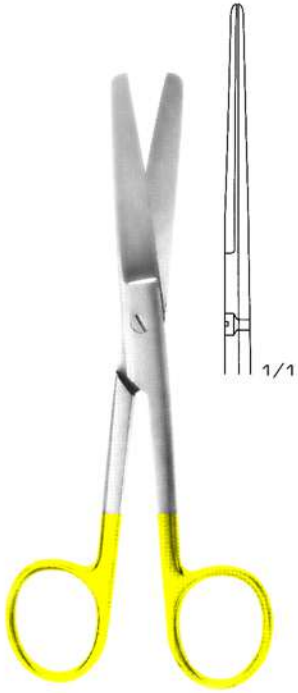

Standard (blunt/blunt - str.)
 05-001-105 10.5 cm / 4¼"
 05-002-115 11.5 cm / 4½"
 05-003-13 13 cm / 5"
 05-004-145 14.5 cm / 5¾"
 05-005-155 15.5 cm / 6"
 05-006-165 16.5 cm / 6½"
 05-007-175 17.5 cm / 6 ⅝"
 05-008-185 18.5 cm / 7¼"
 05-009-20 20 cm / 8"

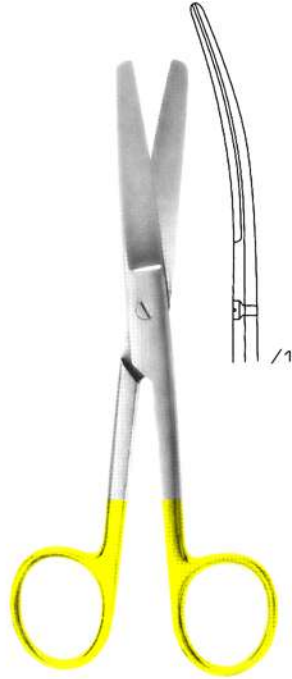

Standard (blunt/blunt - cur.)
 05-010-105 10.5 cm / 4¼"
 05-011-115 11.5 cm / 4½"
 05-012-13 13 cm / 5"
 05-013-145 14.5 cm / 5¾"
 05-014-155 15.5 cm / 6"
 05-015-165 16.5 cm / 6½"
 05-016-175 17.5 cm / 6 ⅝"
 05-017-185 18.5 cm / 7¼"
 05-018-20 20 cm / 8"

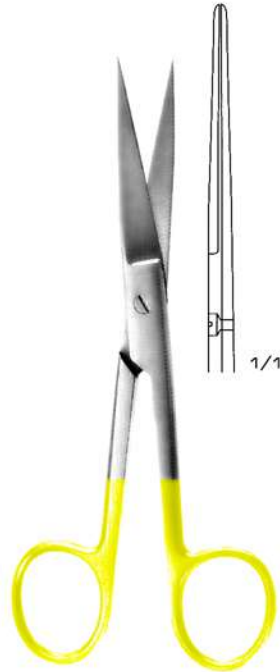

Standard (sharp/sharp - str.)
 05-019-105 10.5 cm / 4¼"
 05-020-115 11.5 cm / 4½"
 05-021-13 13 cm / 5"
 05-022-145 14.5 cm / 5¾"
 05-023-155 15.5 cm / 6"
 05-024-165 16.5 cm / 6½"
 05-025-175 17.5 cm / 6 ⅝"
 05-026-185 18.5 cm / 7¼"
 05-027-20 20 cm / 8"

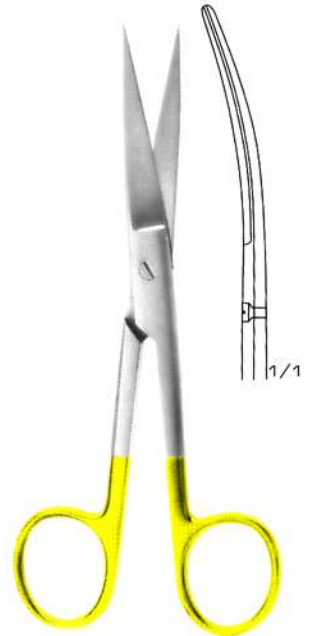

Standard (sharp/sharp - cur.)
 05-028-105 10.5 cm / 4¼"
 05-029-115 11.5 cm / 4½"
 05-030-13 13 cm / 5"
 05-031-145 14.5 cm / 5¾"
 05-032-155 15.5 cm / 6"
 05-033-165 16.5 cm / 6½"
 05-034-175 17.5 cm / 6 ⅝"
 05-035-185 18.5 cm / 7¼"
 05-036-20 20 cm / 8"

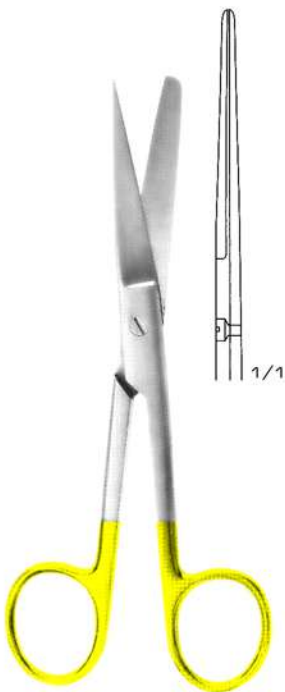

Standard (sharp/blunt - str.)
 05-037-105 10.5 cm / 4¼"
 05-038-115 11.5 cm / 4½"
 05-039-13 13 cm / 5"
 05-040-145 14.5 cm / 5¾"
 05-041-155 15.5 cm / 6"
 05-042-165 16.5 cm / 6½"
 05-043-175 17.5 cm / 6 ⅝"
 05-044-185 18.5 cm / 7¼"
 05-045-20 20 cm / 8"

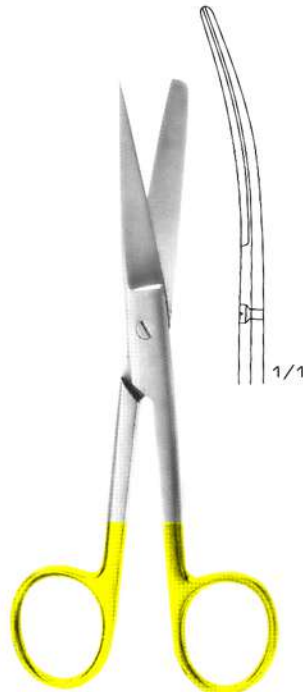

Standard (sharp/blunt - cur.)
 05-046-105 10.5 cm / 4¼"
 05-047-115 11.5 cm / 4½"
 05-048-13 13 cm / 5"
 05-049-145 14.5 cm / 5¾"
 05-050-155 15.5 cm / 6"
 05-051-165 16.5 cm / 6½"
 05-052-175 17.5 cm / 6 ⅝"
 05-053-185 18.5 cm / 7¼"
 05-054-20 20 cm / 8"



Iris
 05-055-115
 11.5 cm / 4½"

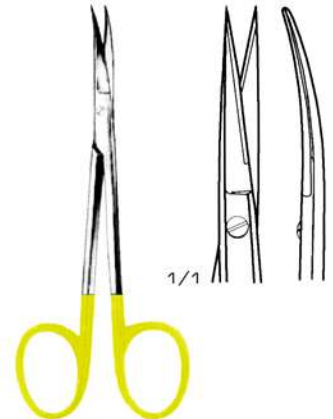

Iris
 05-056-115
 11.5 cm / 4½"



GOLD LINE

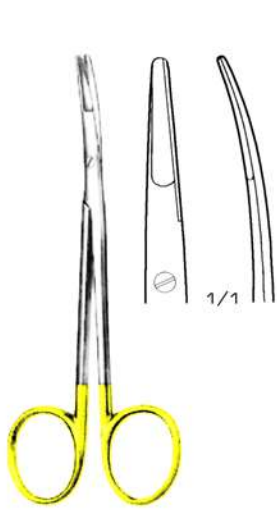

Ragnell (Kilner)
05-057-12
12 cm / 4¾"

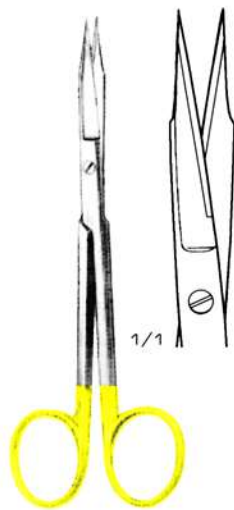

Goldman-Fox
05-058-13
13 cm / 5⅛"

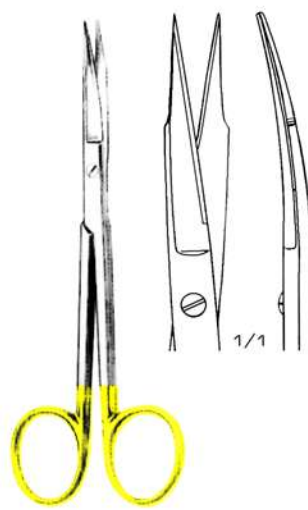

Goldman-Fox
05-059-13
13 cm / 5⅛"

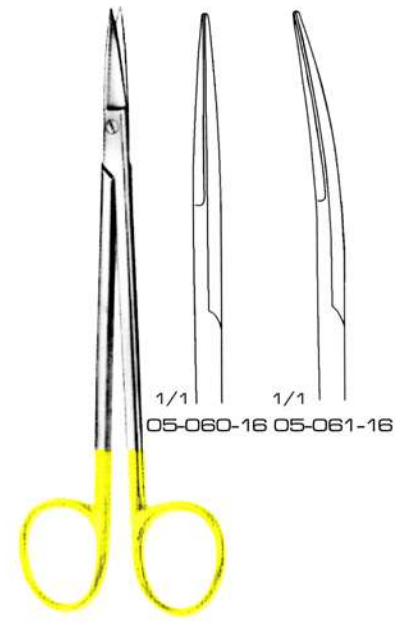

Kelly
16 cm / 6¼"



Potts-Smith
05-062-19 To 05-067-23

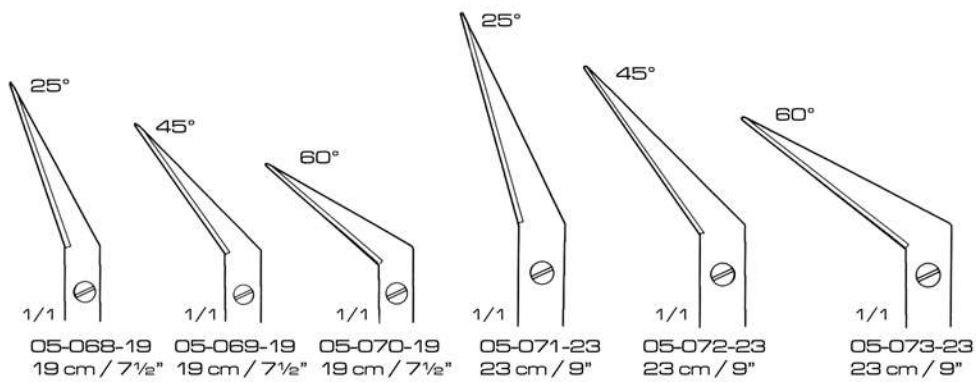
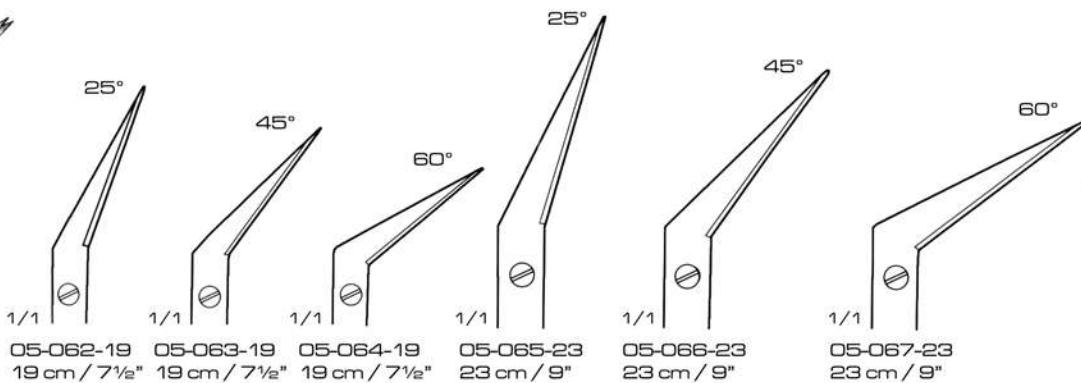

Potts-Smith
05-068-19 To 05-073-23

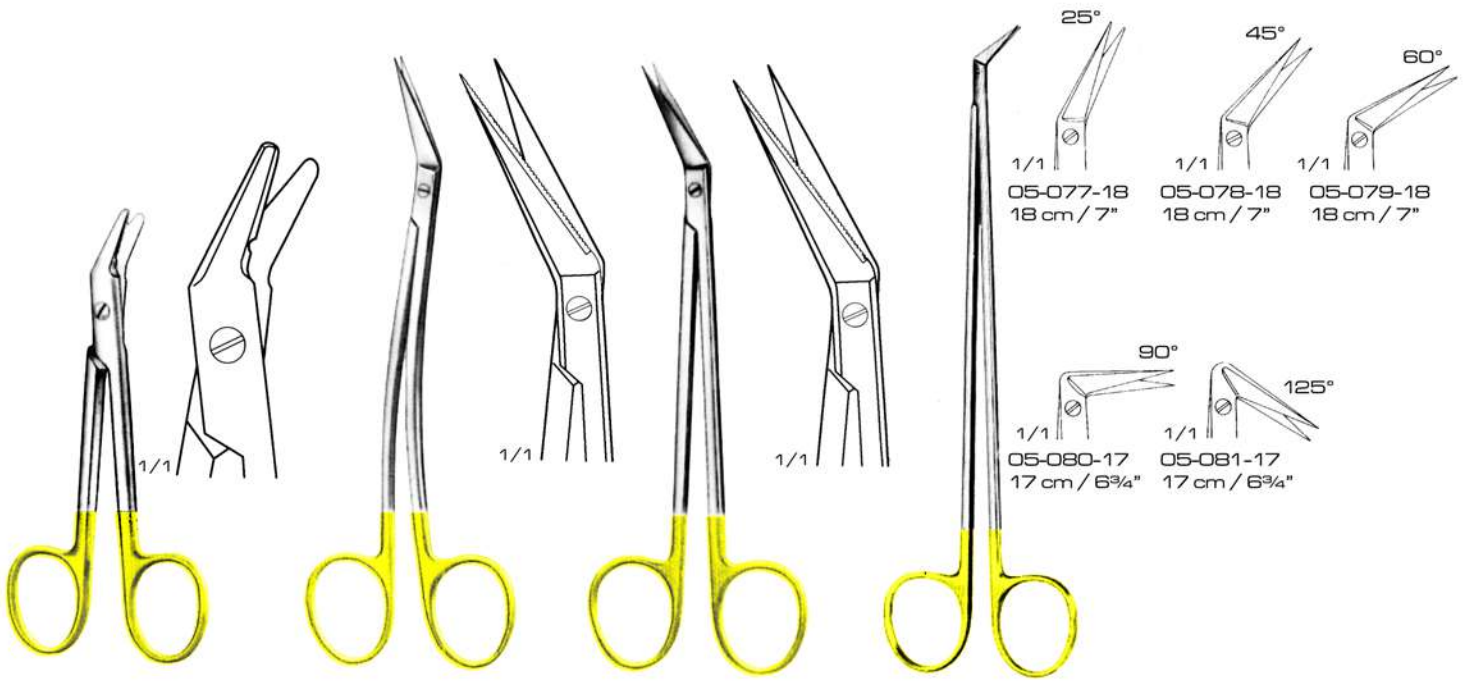

Universal
05-074-12
12 cm / 4¾"

Lockin
(One Blade Serrated)
05-075-16
16 cm / 6¼"

Lockin
(One Blade Serrated)
05-076-16
16 cm / 6¼"

Dietrich

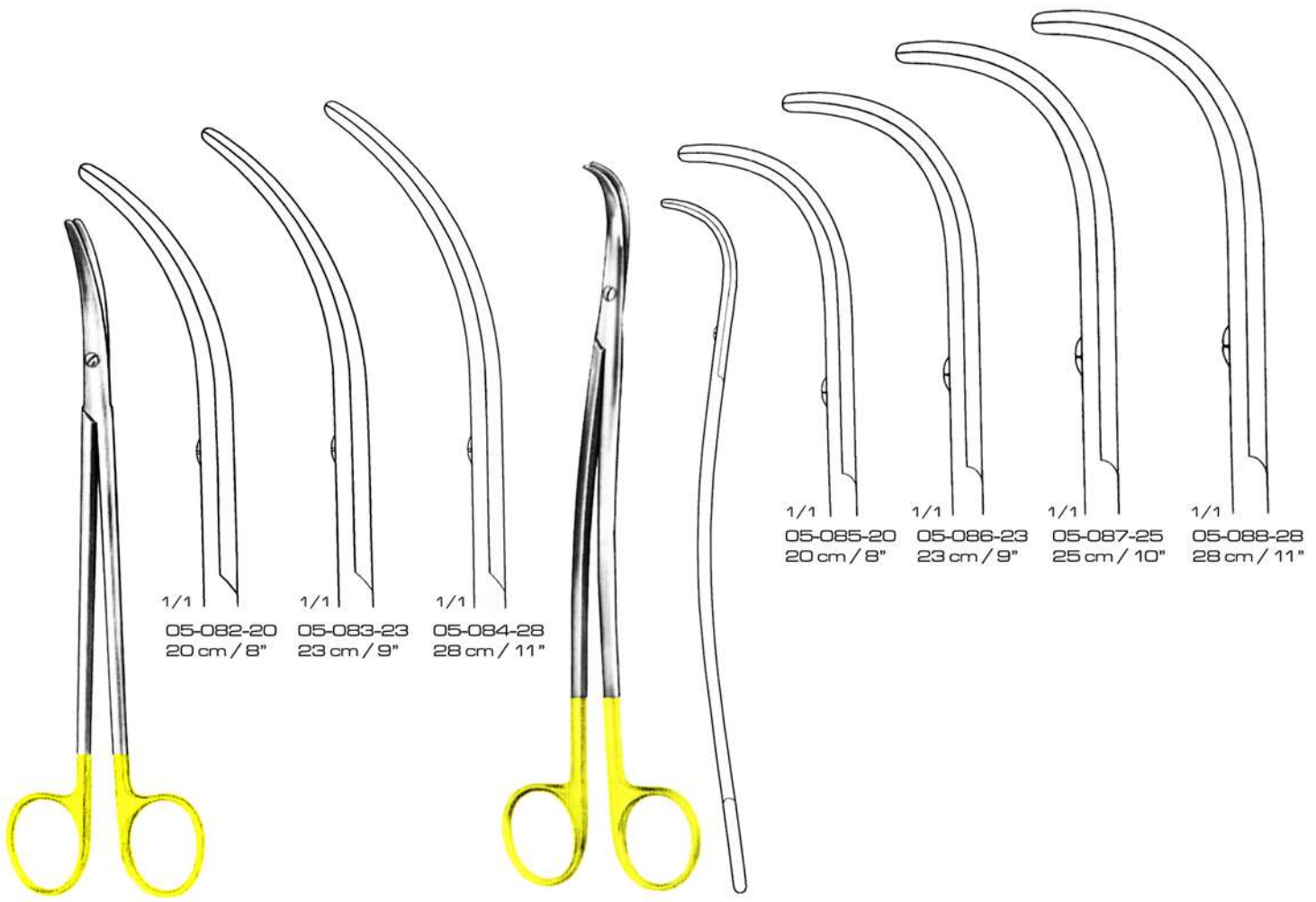
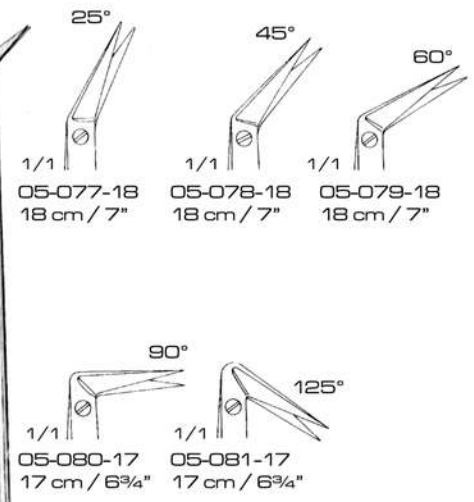

1/1 05-082-20 20 cm / 8"
1/1 05-083-23 23 cm / 9"
1/1 05-084-28 28 cm / 11"

1/1 05-085-20 20 cm / 8"
1/1 05-086-23 23 cm / 9"
1/1 05-087-25 25 cm / 10"
1/1 05-088-28 28 cm / 11"

Metzenbaum-Thorek

Metzenbaum-S



GOLD LINE

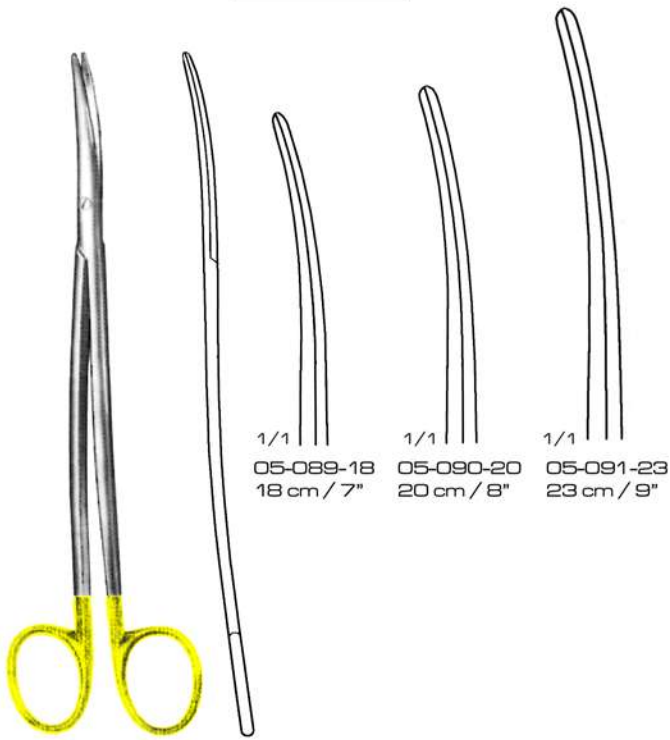

Metzenbaum-Fino

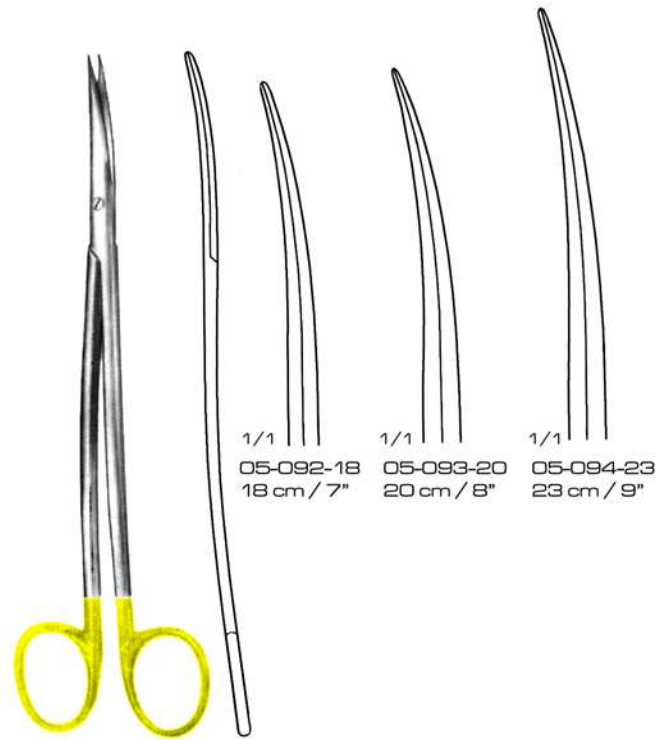
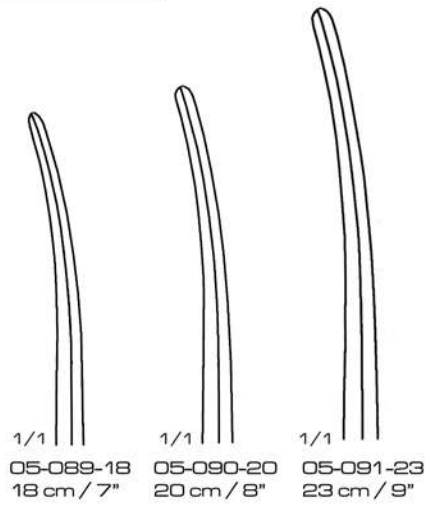

Metzenbaum-Fino

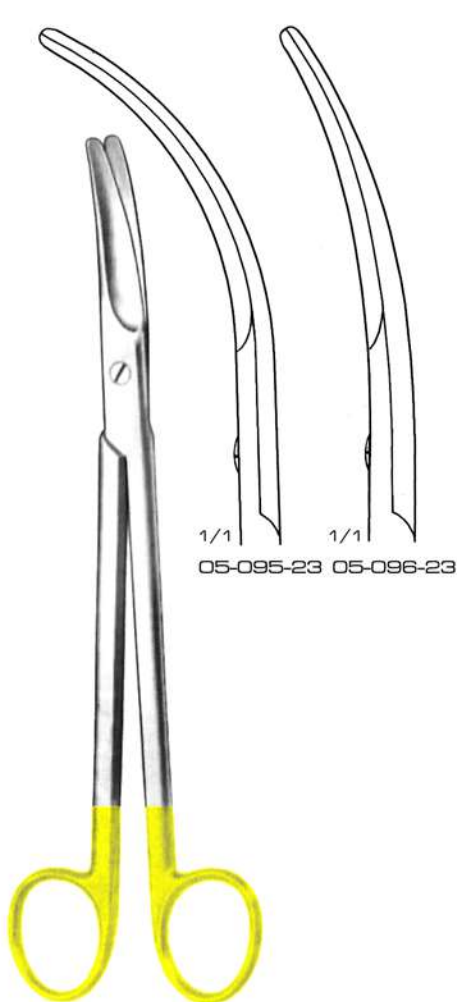
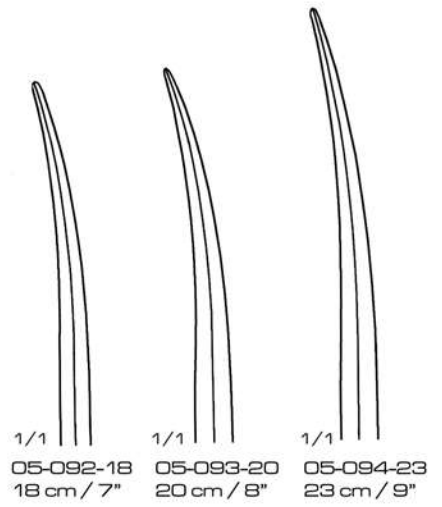

Parametrium
23 cm / 9"

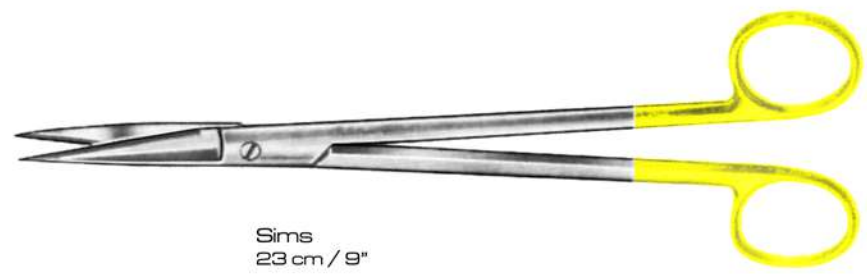
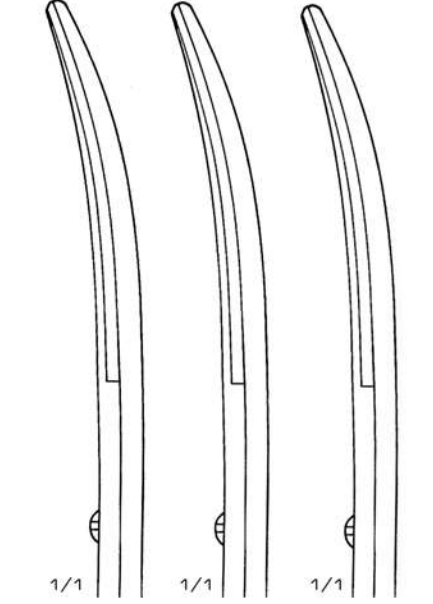
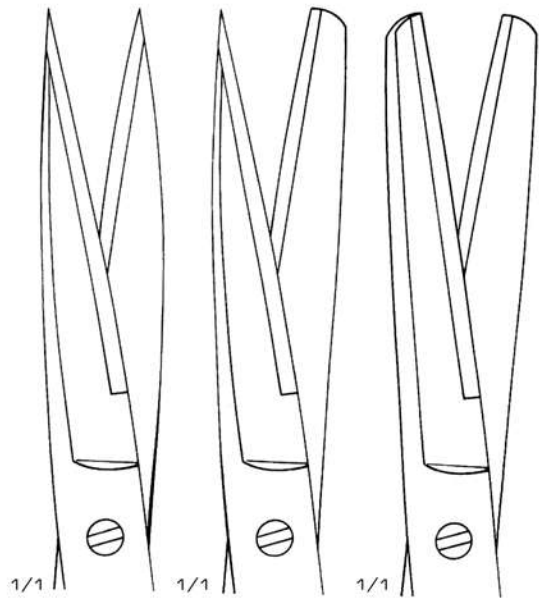
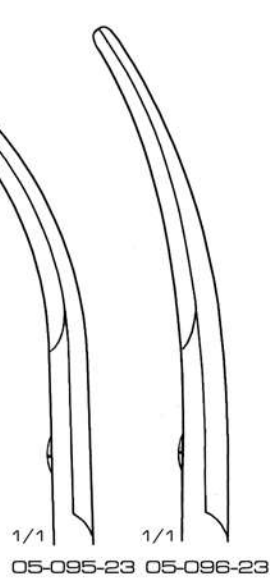

Sims
23 cm / 9"

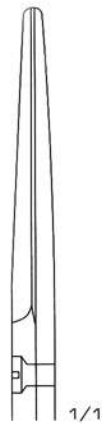
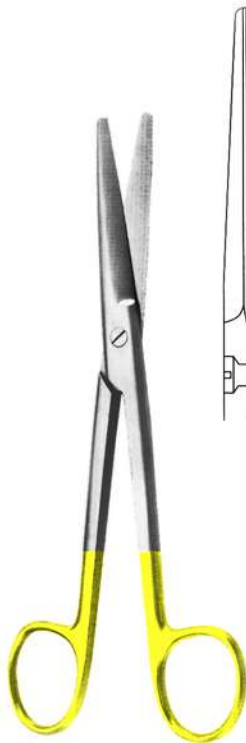

Mayo (str.)
 05-103-14 14 cm / 5½"
 05-104-17 17 cm / 6¾"
 05-105-23 23 cm / 9"

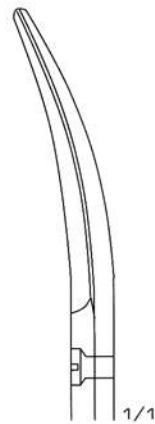
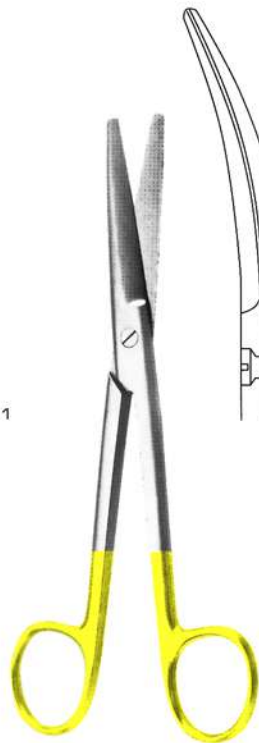

Mayo (cur.)
 05-106-14 14 cm / 5½"
 05-107-17 17 cm / 6¾"
 05-108-23 23 cm / 9"

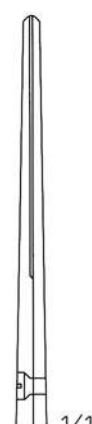
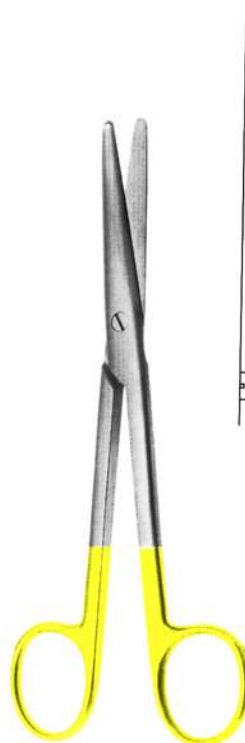

Mayo-Stille (str.)
 05-109-15 15 cm / 6"
 05-110-17 17 cm / 6¾"
 05-111-19.5 19.5 cm / 7¾"
 05-112-21.5 21.5 cm / 8¼"

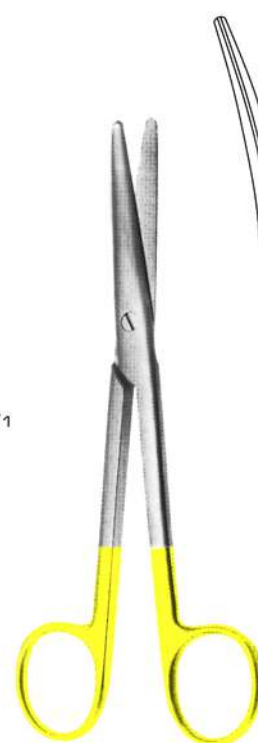

Mayo-Stille (cur.)
 05-113-15 15 cm / 6"
 05-114-17 17 cm / 6¾"
 05-115-19.5 19.5 cm / 7¾"
 05-116-21.5 21.5 cm / 8¼"

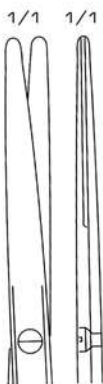
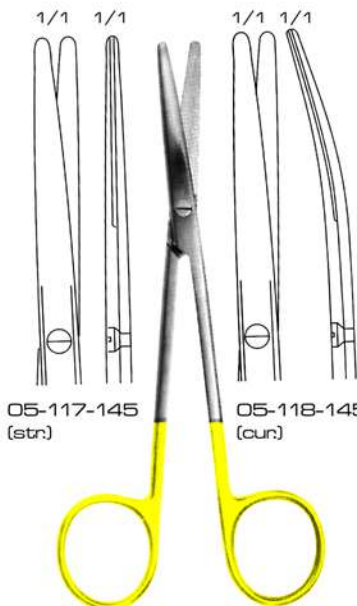

05-117-145 (str.)

Metzenbaum
 14.5 cm / 5¾"

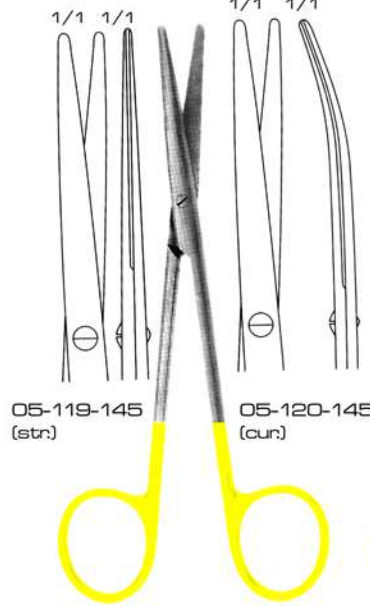

05-118-145 (cur.)

Metzenbaum-Fino
 14.5 cm / 5¾"

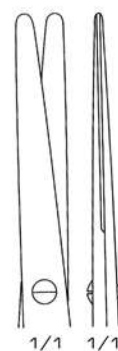

Metzenbaum (str.)
 05-121-18 18 cm / 7"
 05-122-20 20 cm / 8"
 05-123-23 23 cm / 9"
 05-124-25 25 cm / 10"
 05-125-28 28 cm / 11"
 05-126-30 30 cm / 12"

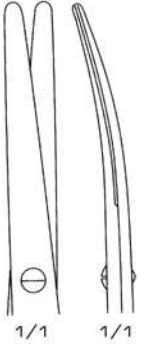
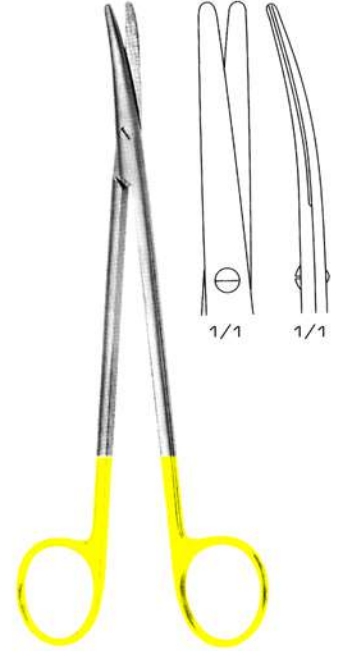

Metzenbaum (cur.)
 05-127-18 18 cm / 7"
 05-128-20 20 cm / 8"
 05-129-23 23 cm / 9"
 05-130-25 25 cm / 10"
 05-131-28 28 cm / 11"
 05-132-30 30 cm / 12"

GOLD LINE

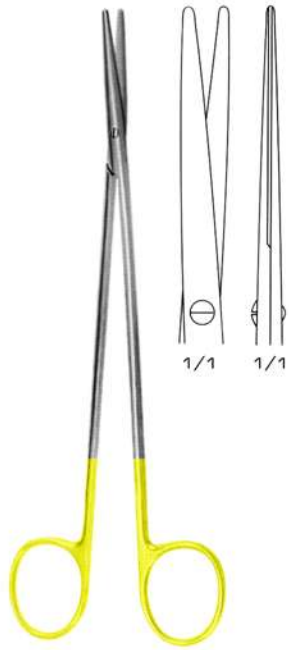

Metzenbaum-Fino
05-133-18 18 cm / 7"
05-134-20 20 cm / 8"
05-135-23 23 cm / 9"
05-136-25 25 cm / 10"

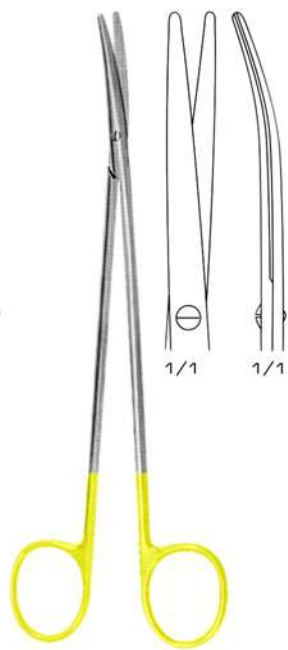

Metzenbaum-Fino
05-137-18 18 cm / 7"
05-138-20 20 cm / 8"
05-139-23 23 cm / 9"
05-140-25 25 cm / 10"



Lexer
05-141-16
16 cm / 6 1/4"

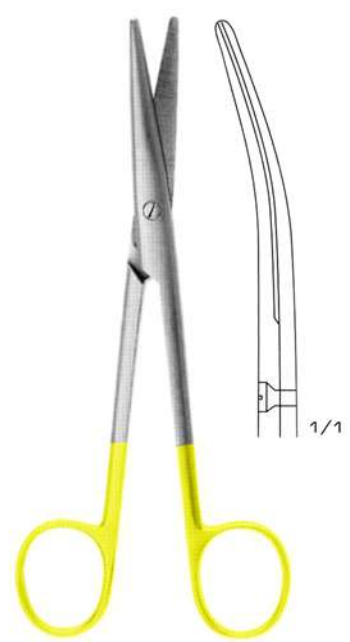

Lexer
05-142-16
16 cm / 6 1/4"

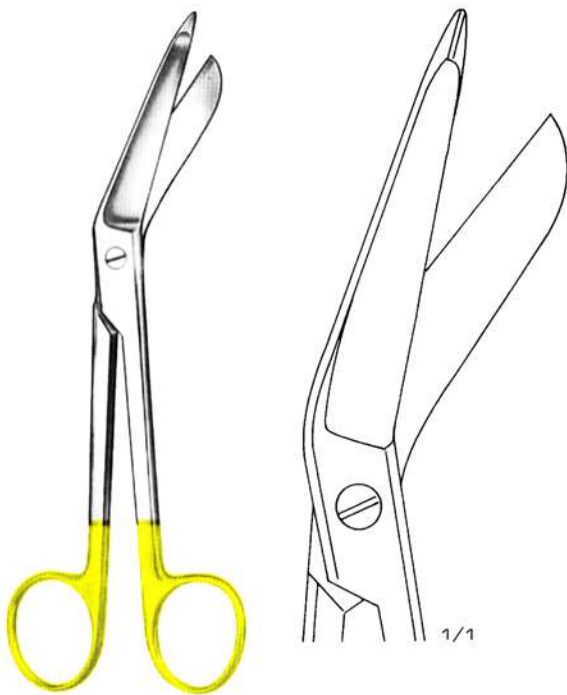

Lister
05-143-18
18 cm / 7"

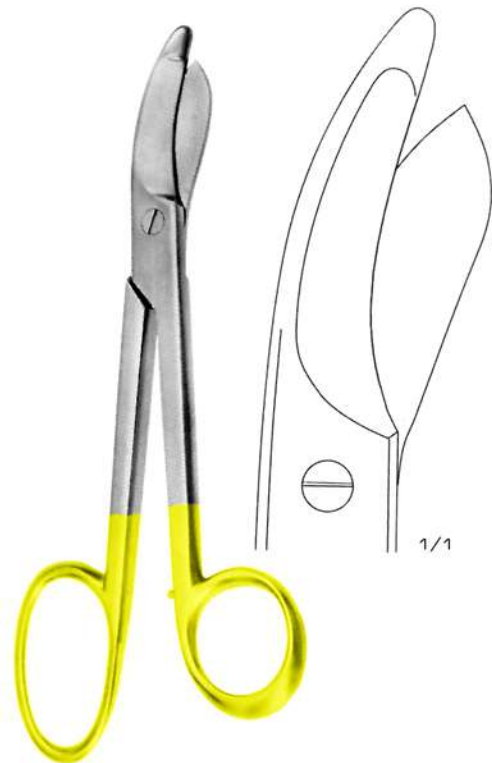

Bruns
05-144-24
24 cm / 9 1/2"

SUPER CUT

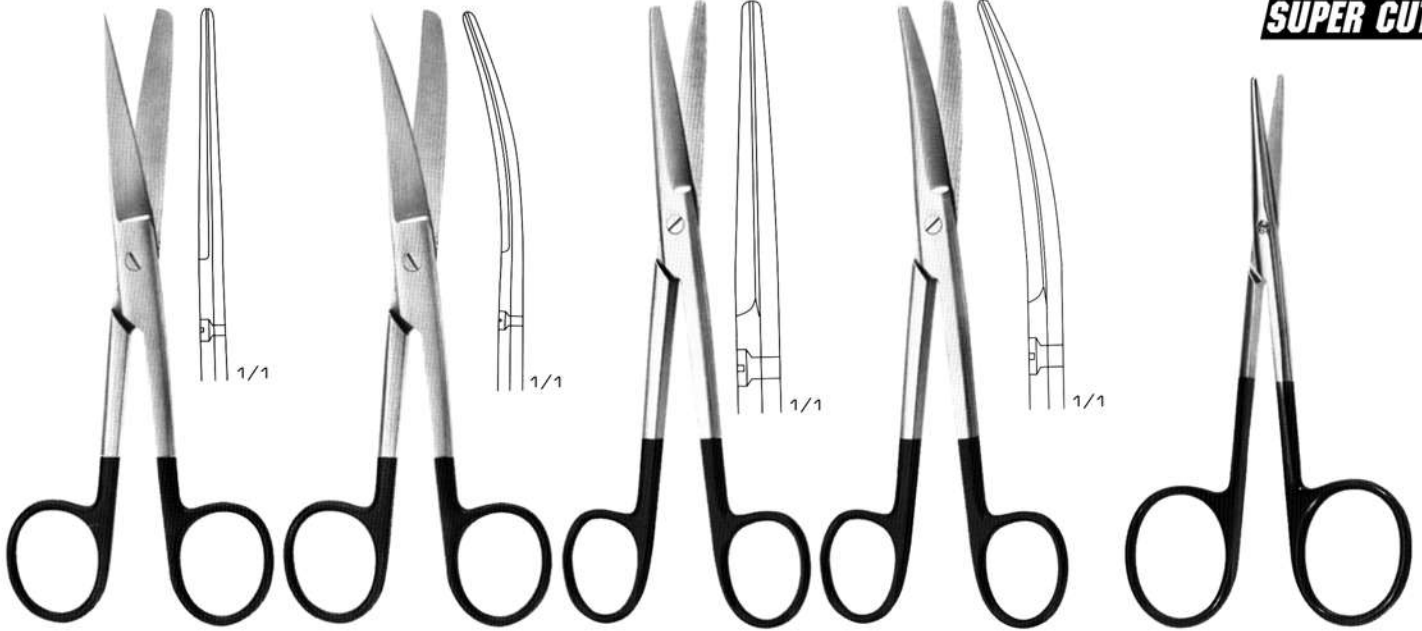

Standard
05-145-13
13 cm / 5"
05-146-145
14.5 cm / 5¾"

Standard
05-147-13
13 cm / 5"
05-148-145
14.5 cm / 5¾"

Mayo
05-149-145
14.5 cm / 5¾"
05-150-17
17 cm / 6¾"
05-151-23
23 cm / 9"

Mayo
05-152-145
14.5 cm / 5¾"
05-153-17
17 cm / 6¾"
05-154-23
23 cm / 9"

Baby-Metzenbaum
05-155-145
14.5 cm / 5¾"

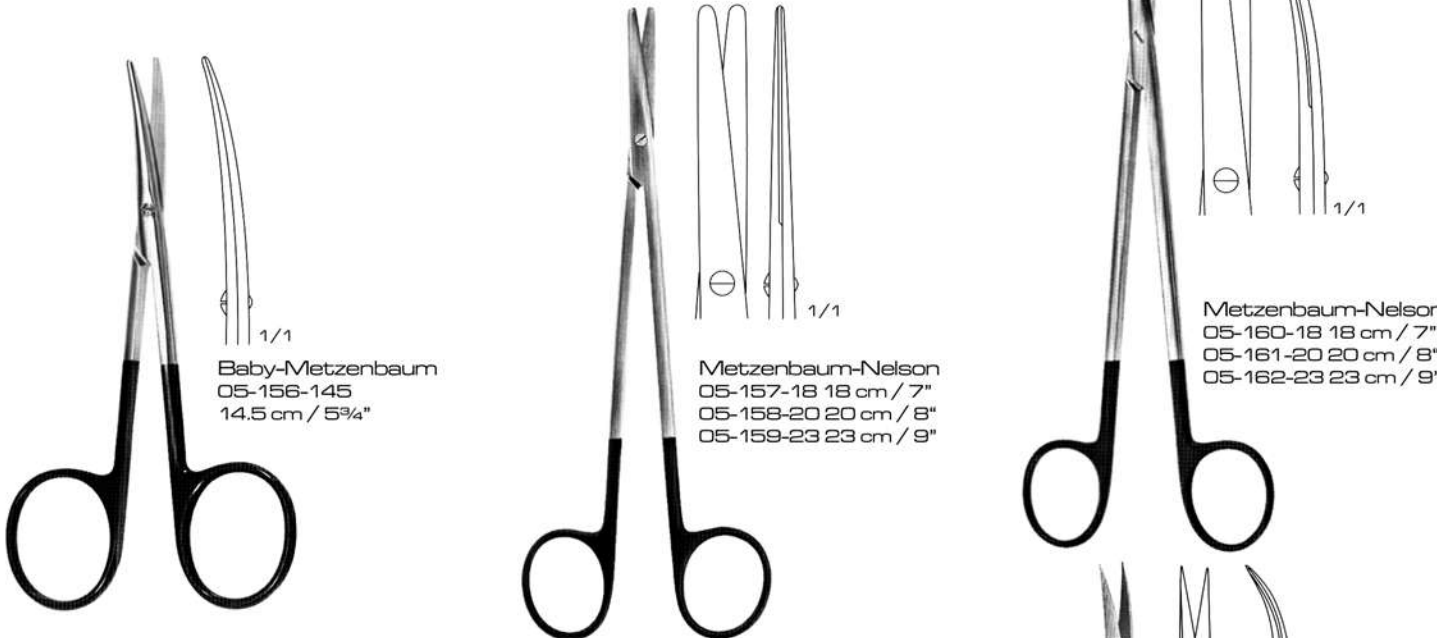

Baby-Metzenbaum
05-156-145
14.5 cm / 5¾"

Metzenbaum-Nelson
05-157-18 18 cm / 7"
05-158-20 20 cm / 8"
05-159-23 23 cm / 9"

Metzenbaum-Nelson
05-160-18 18 cm / 7"
05-161-20 20 cm / 8"
05-162-23 23 cm / 9"

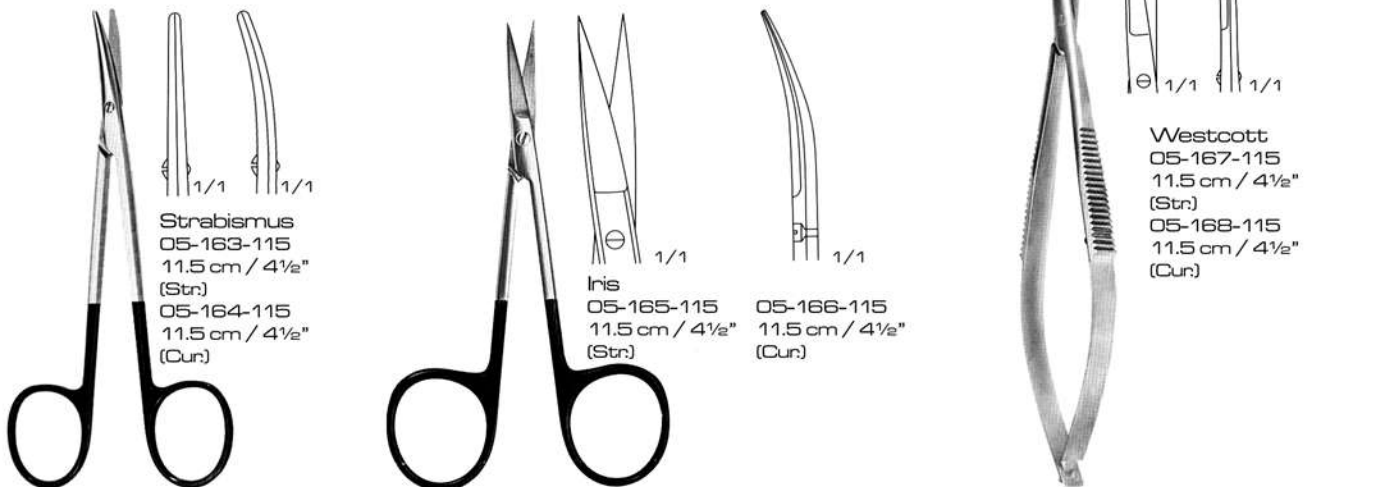

Strabismus
05-163-115
11.5 cm / 4½"
(Str)
05-164-115
11.5 cm / 4½"
(Cur)

Iris
05-165-115
11.5 cm / 4½"
(Str)
05-166-115
11.5 cm / 4½"
(Cur)

Westcott
05-167-115
11.5 cm / 4½"
(Str)
05-168-115
11.5 cm / 4½"
(Cur)

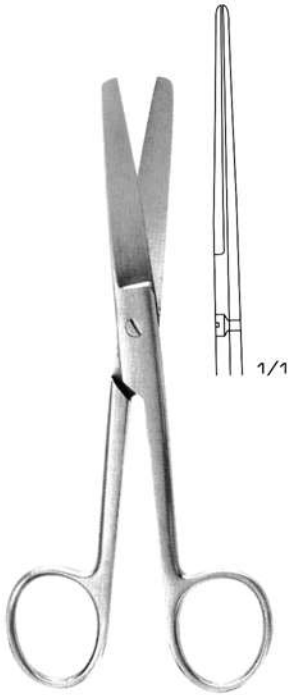

Standard
 05-169-105 10.5 cm / 4 1/4"
 05-170-115 11.5 cm / 4 1/2"
 05-171-13 13 cm / 5"
 05-172-145 14.5 cm / 5 3/4"
 05-173-155 15.5 cm / 6"
 05-174-165 16.5 cm / 6 1/2"
 05-175-175 17.5 cm / 6 5/8"
 05-176-185 18.5 cm / 7 1/4"
 05-177-20 20 cm / 8"

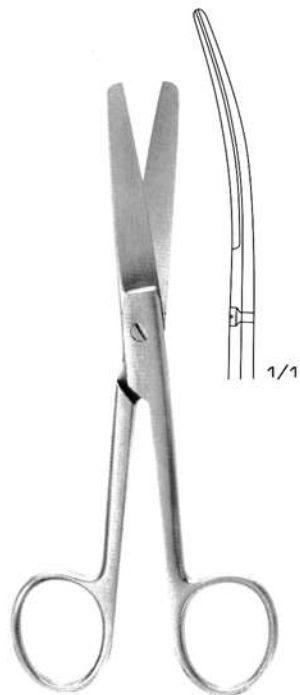

Standard
 05-178-105 10.5 cm / 4 1/4"
 05-179-115 11.5 cm / 4 1/2"
 05-180-13 13 cm / 5"
 05-181-145 14.5 cm / 5 3/4"
 05-182-155 15.5 cm / 6"
 05-183-165 16.5 cm / 6 1/2"
 05-184-175 17.5 cm / 6 5/8"
 05-185-185 18.5 cm / 7 1/4"
 05-186-20 20 cm / 8"

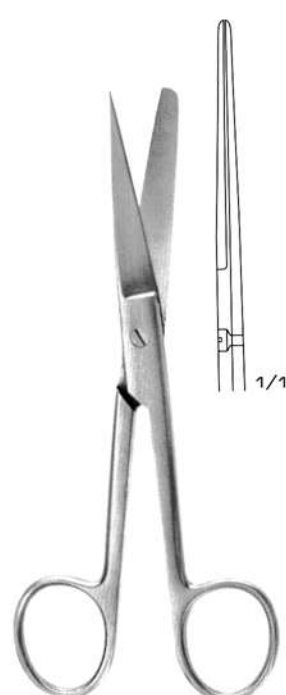

Standard
 05-187-105 10.5 cm / 4 1/4"
 05-188-115 11.5 cm / 4 1/2"
 05-189-13 13 cm / 5"
 05-190-145 14.5 cm / 5 3/4"
 05-191-155 15.5 cm / 6"
 05-192-165 16.5 cm / 6 1/2"
 05-193-175 17.5 cm / 6 5/8"
 05-194-185 18.5 cm / 7 1/4"
 05-195-20 20 cm / 8"

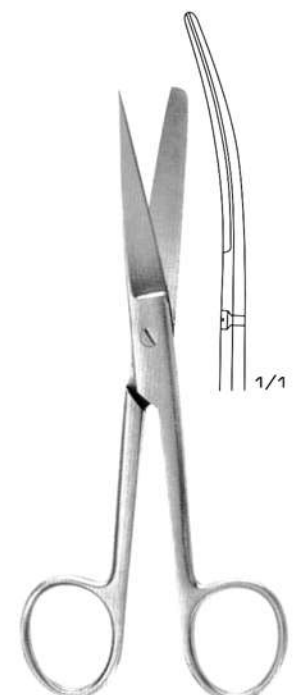

Standard
 05-196-105 10.5 cm / 4 1/4"
 05-197-115 11.5 cm / 4 1/2"
 05-198-13 13 cm / 5"
 05-199-145 14.5 cm / 5 3/4"
 05-200-155 15.5 cm / 6"
 05-201-165 16.5 cm / 6 1/2"
 05-202-175 17.5 cm / 6 5/8"
 05-203-185 18.5 cm / 7 1/4"
 05-204-20 20 cm / 8"

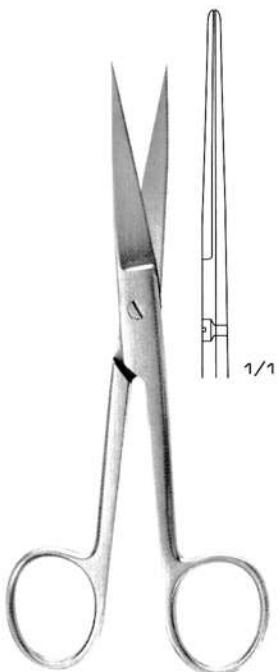

Standard
 05-205-105 10.5 cm / 4 1/4"
 05-206-115 11.5 cm / 4 1/2"
 05-207-13 13 cm / 5"
 05-208-145 14.5 cm / 5 3/4"
 05-209-155 15.5 cm / 6"
 05-210-165 16.5 cm / 6 1/2"
 05-211-175 17.5 cm / 6 5/8"
 05-212-185 18.5 cm / 7 1/4"
 05-213-20 20 cm / 8"

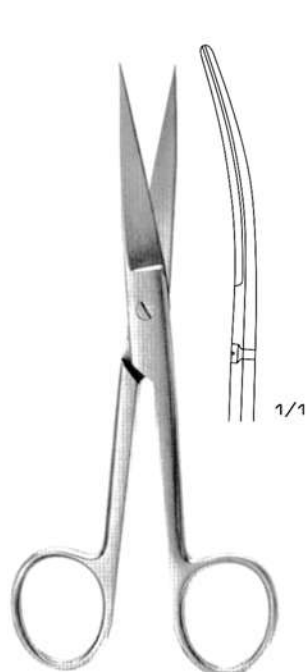

Standard
 05-214-105 10.5 cm / 4 1/4"
 05-215-115 11.5 cm / 4 1/2"
 05-216-13 13 cm / 5"
 05-217-145 14.5 cm / 5 3/4"
 05-218-155 15.5 cm / 6"
 05-219-165 16.5 cm / 6 1/2"
 05-220-175 17.5 cm / 6 5/8"
 05-221-185 18.5 cm / 7 1/4"
 05-222-20 20 cm / 8"

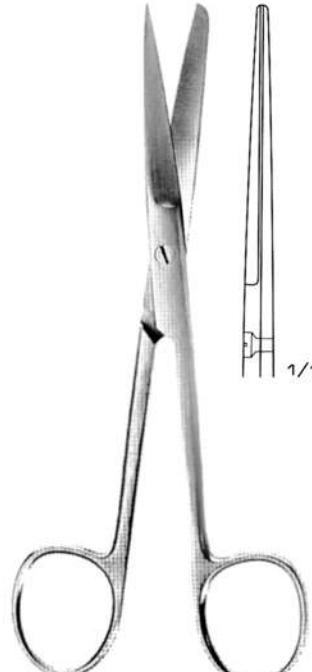

Deaver
 05-223-145
 14.5 cm / 5 3/4"

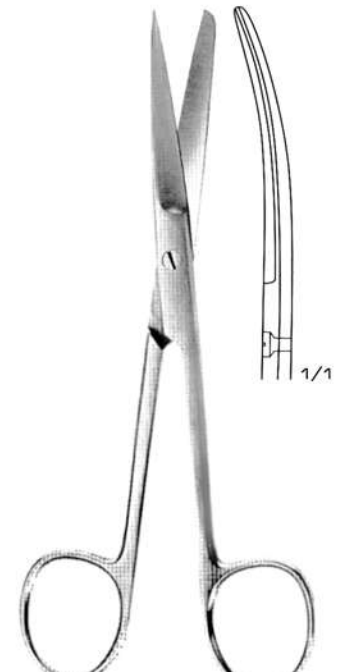

Deaver
 05-224-145
 14.5 cm / 5 3/4"

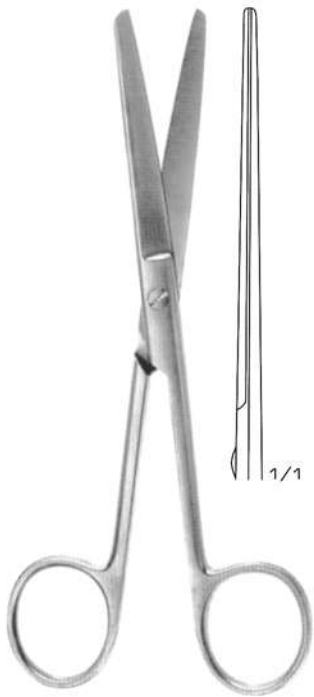

Grazil

05-225-13 13 cm / 5"
05-226-145 14.5 cm / 5¾"

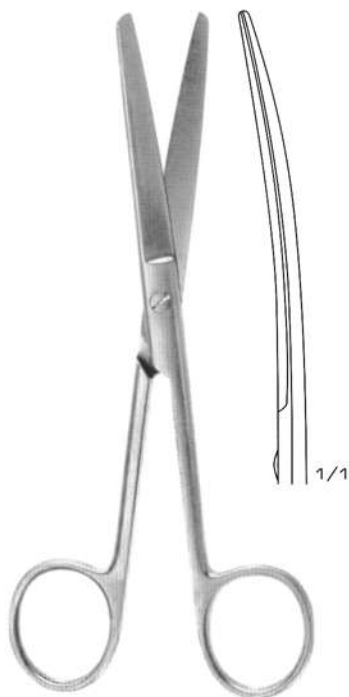

Grazil

05-227-13 13 cm / 5"
05-228-145 14.5 cm / 5¾"



Grazil

05-229-13 13 cm / 5"
05-230-145 14.5 cm / 5¾"

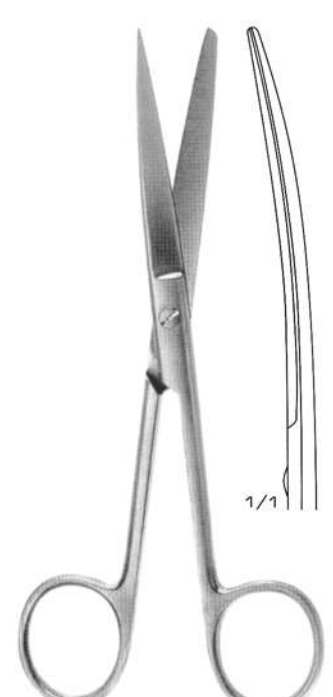

Grazil

05-231-13 13 cm / 5"
05-232-145 14.5 cm / 5¾"



Grazil

05-233-13 13 cm / 5"
05-234-145 14.5 cm / 5¾"

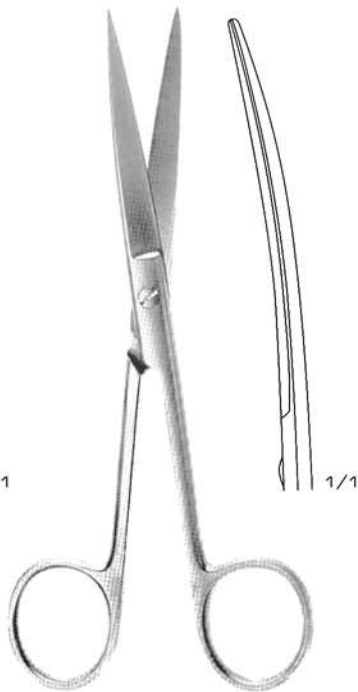

Grazil

05-235-13 13 cm / 5"
05-236-145 14.5 cm / 5¾"

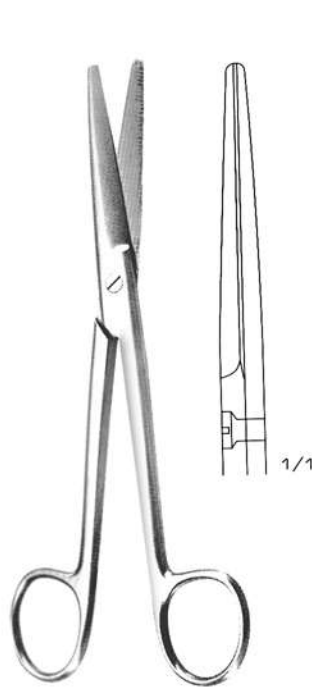

Mayo

05-237-145 14.5 cm / 5¾"
05-238-17 17 cm / 6¾"
05-239-23 23 cm / 9"

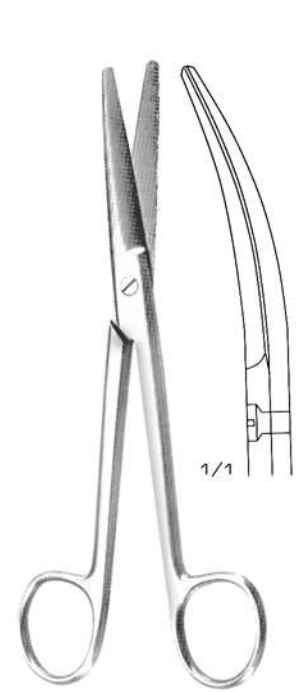

Mayo

05-240-145 14.5 cm / 5¾"
05-241-17 17 cm / 6¾"
05-242-23 23 cm / 9"

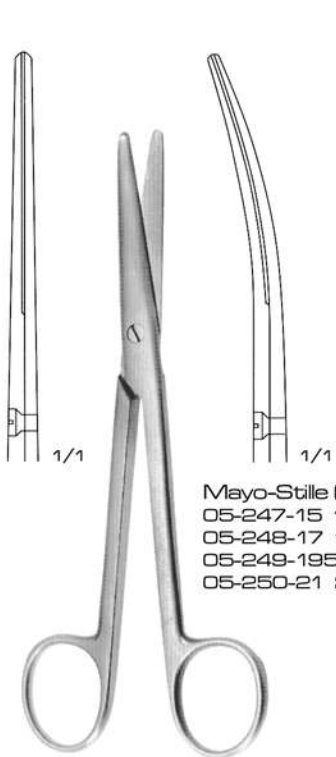

Mayo-Stille (cur)
 05-247-15 15 cm / 6"
 05-248-17 17 cm / 6¾"
 05-249-195 19.5 cm / 7¾"
 05-250-21 21 cm / 8¼"

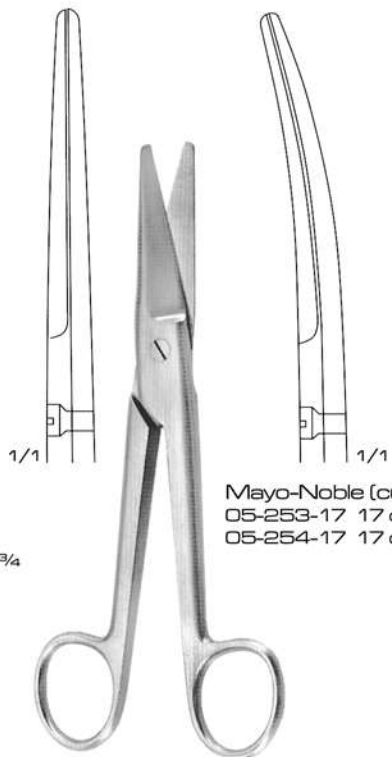

Mayo-Noble (cur)
 05-253-17 17 cm / 6¾"
 05-254-17 17 cm / 6¾"

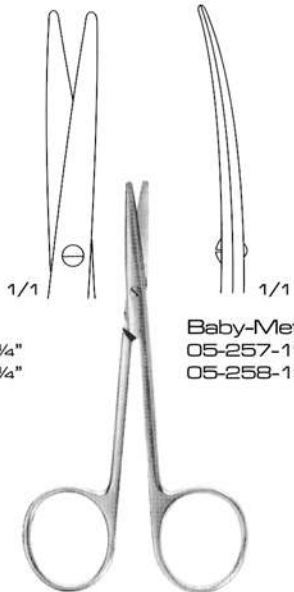

Baby-Metzezenbaum (cur)
 05-257-11 11.5 cm / 4½"
 05-258-11 11.5 cm / 4½"

Mayo-Stille (str)
 05-243-15 15 cm / 6"
 05-244-17 17 cm / 6¾"
 05-245-195 19.5 cm / 7¾"
 05-246-21 21 cm / 8¼"

Mayo-Noble (str)
 05-251-17 17 cm / 6¾"
 05-252-17 17 cm / 6¾"

Baby-Metzezenbaum (str)
 05-255-11 11.5 cm / 4½"
 05-256-11 11.5 cm / 4½"

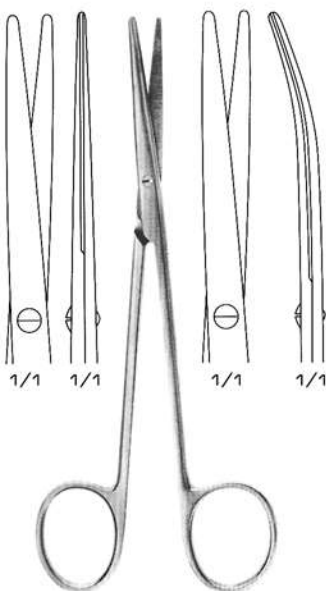

Metzzenbaum-Fino
 05-259-145 14.5 cm / 5¾"
 (str)
 05-260-145 14.5 cm / 5¾"
 (cur)

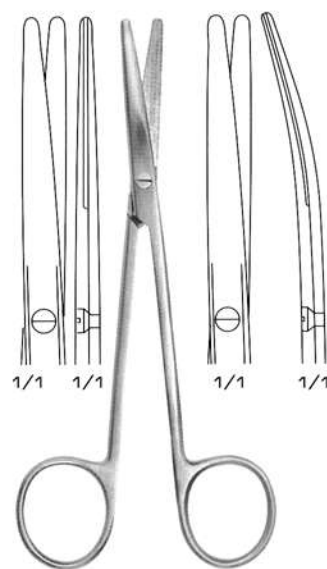

Metzzenbaum
 05-261-145 14.5 cm / 5¾"
 (str)
 05-262-145 14.5 cm / 5¾"
 (cur)

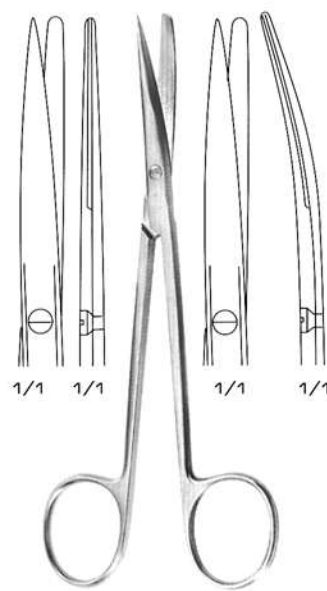

Metzzenbaum
 05-263-145 14.5 cm / 5¾"
 (str)
 05-264-145 14.5 cm / 5¾"
 (cur)

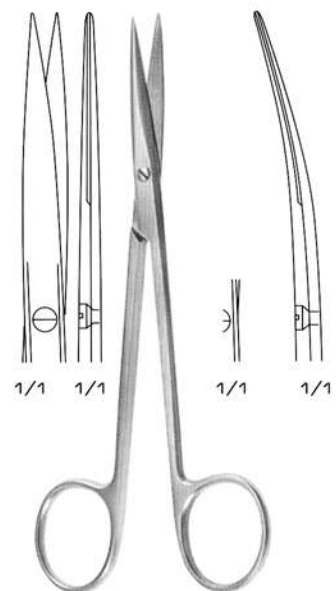

Metzzenbaum
 05-265-145 14.5 cm / 5¾"
 (str)
 05-266-145 14.5 cm / 5¾"
 (cur)

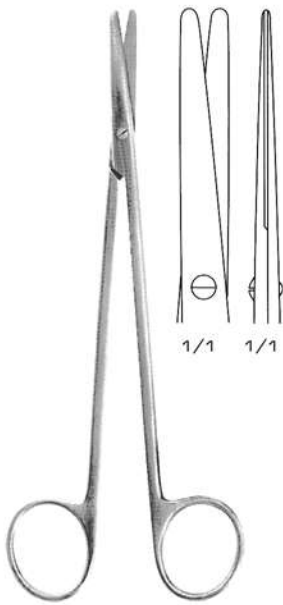

Metzenbaum
 05-267-18 18 cm / 7"
 05-268-20 20 cm / 8"
 05-269-23 23 cm / 9"
 05-270-25 25 cm / 10"
 05-271-28 28 cm / 11"
 05-272-30 30 cm / 12"

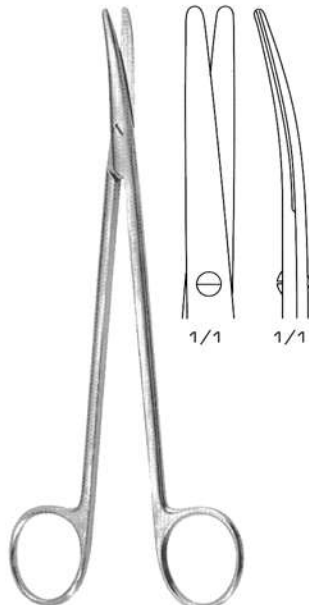

Metzenbaum
 05-273-18 18 cm / 7"
 05-274-20 20 cm / 8"
 05-275-23 23 cm / 9"
 05-276-25 25 cm / 10"
 05-277-28 28 cm / 11"
 05-278-30 30 cm / 12"

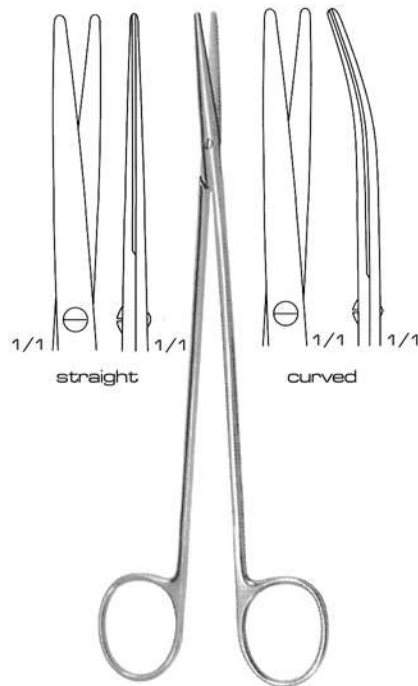

Metzenbaum-Fino
 Straight Curved
 05-279-18 05-285-18 18 cm / 7"
 05-280-20 05-286-20 20 cm / 8"
 05-281-23 05-287-23 23 cm / 9"
 05-282-25 05-288-25 25 cm / 10"
 05-283-28 05-289-28 28 cm / 11"
 05-284-30 05-290-30 30 cm / 12"

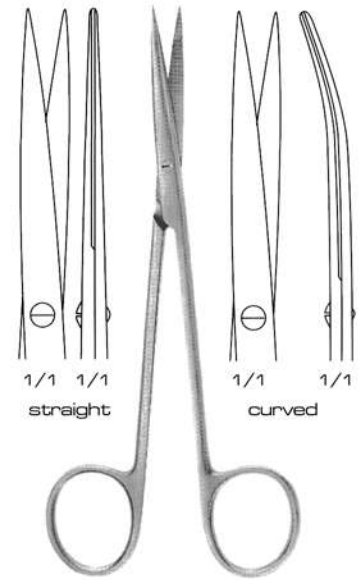

Brophy
 05-291-145 14.5 cm / 5¾"
 05-292-18 18 cm / 7"
 (str)
 05-293-145 14.5 cm / 5¾"
 05-294-18 18 cm / 7"
 (cur)

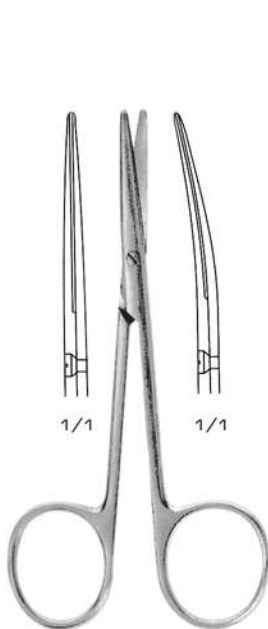

Baby-Lexer
 05-295-10 10 cm / 4" (str)
 05-296-10 10 cm / 4" (cur)

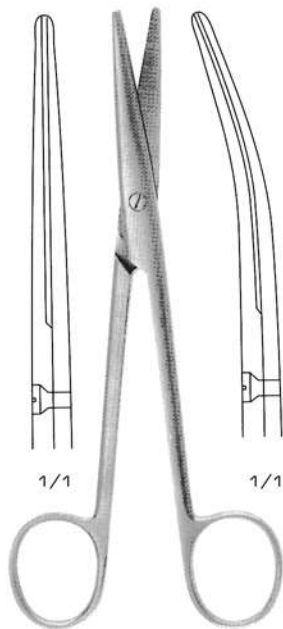

Lexer
 05-297-16 16 cm / 6¼" (str)
 05-298-16 16 cm / 6¼" (cur)

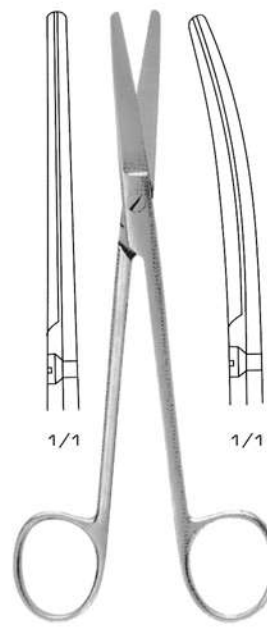

Mixer
 05-299-17 17 cm / 6¾" (str)
 05-300-17 17 cm / 6¾" (cur)

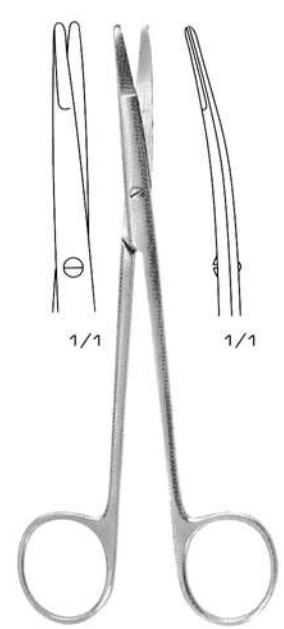

Kilner (Ragnell)
 05-301-12 12 cm / 4¾"
 05-302-15 15 cm / 6"

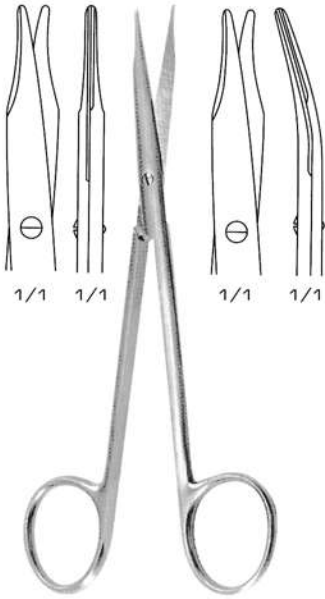

Reynolds
05-303-15
15 cm / 6"
(str.)
05-304-15
15 cm / 6"
(cur.)

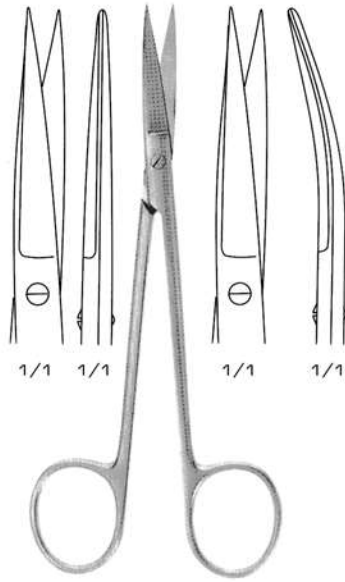

Joseph
05-305-14
14 cm / 5½"
(str.)
05-306-14
14 cm / 5½"
(cur.)



Wagner
12 cm / 4¾"

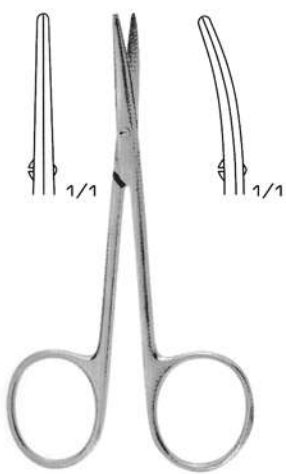

Strabismus
05-313-115
11.5 cm / 4½"
(str.)
05-314-115
11.5 cm / 4½"
(cur.)

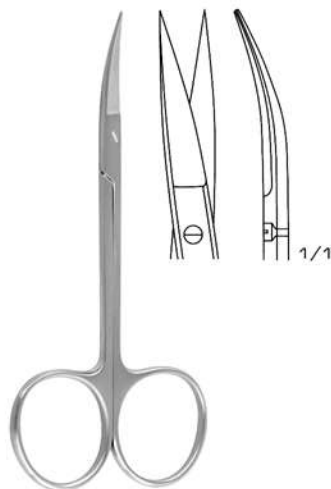

Iris
05-315-115
11.5 cm / 4½"
(str.)
05-316-115
11.5 cm / 4½"
(cur.)

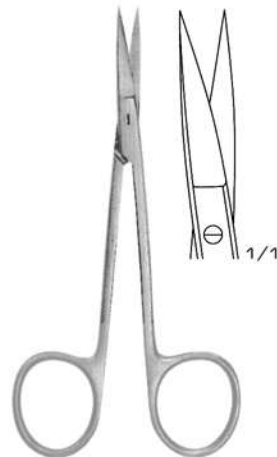

Iris
05-317-09
9 cm / 4⅛"
05-318-105
10.5 cm / 4¼"
05-319-115
11.5 cm / 4½"

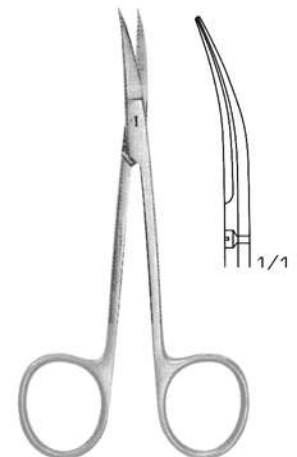

Iris
05-320-09
9 cm / 4⅛"
05-321-105
10.5 cm / 4¼"
05-322-115
11.5 cm / 4½"

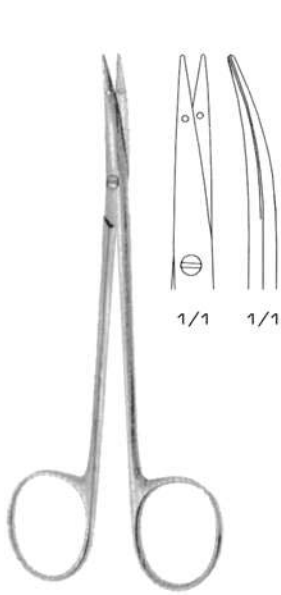

Littler
05-323-115
11.5 cm / 4½"



05-324-115
11.5 cm / 4½"

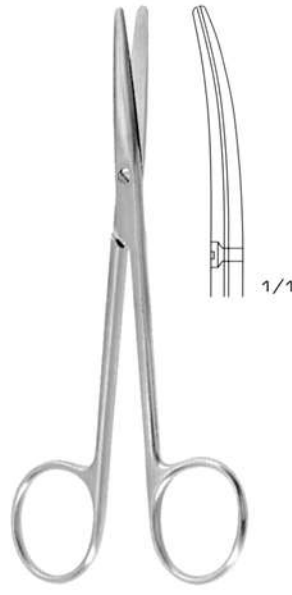

Landolt
05-325-125
12.5 cm / 5"

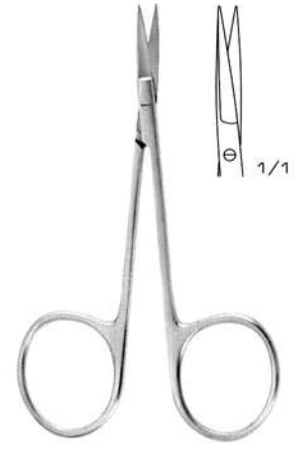

Mod. Bonn
05-326-08
8 cm / 3¼"

sharp / sharp

blunt / blunt



05-334-105
05-335-115

05-336-105
05-337-115



Mod. Bonn
05-327-08
8 cm / 3¼"



Fergusson
05-328-18
18 cm / 7"



Spencer
05-329-09 9 cm / 4"
05-330-105 10.5 cm / 4¼"
05-331-13 13 cm / 5"
05-332-14 14 cm / 5½"

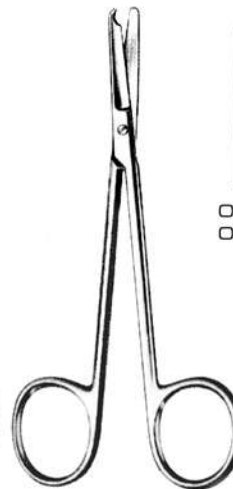

Spencer-Delicate
05-333-11
11 cm / 4¼"

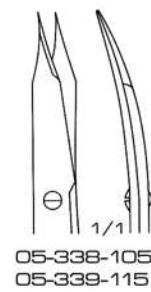

05-338-105
05-339-115

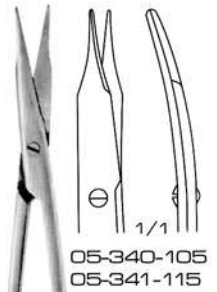

05-340-105
05-341-115

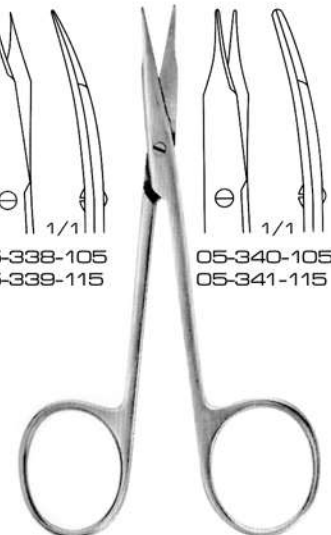

Stevens
05-334-105 10.5 cm / 4¼"
05-335-115 11.5 cm / 4½"
05-336-105 10.5 cm / 4¼"
05-337-115 11.5 cm / 4½"
05-338-105 10.5 cm / 4¼"
05-339-115 11.5 cm / 4½"
05-340-105 10.5 cm / 4¼"
05-341-115 11.5 cm / 4½"



Littauer
05-342-14
14 cm / 5½"

Shortbent
05-343-09
9 cm / 3½"

Good
19 cm / 7½"

Northbent
05-346-13
13 cm / 5"

05-344-19 (str) 1/1
05-345-19 (cur) 1/1

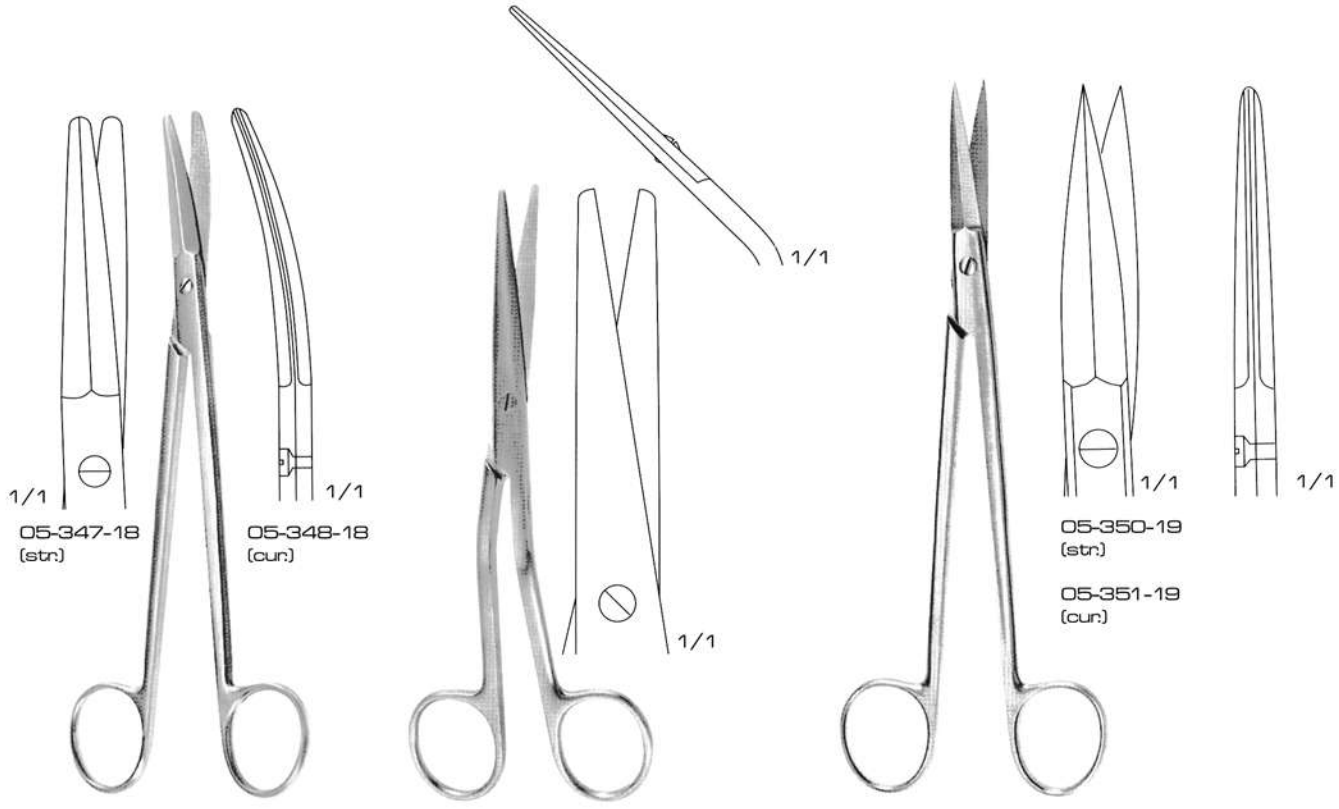

05-347-18 (str) 1/1

05-348-18 (cur) 1/1

Boettcher
18 cm / 7"

1/1

Cottle
05-349-16
16 cm / 6¼"

05-350-19 (str) 1/1

05-351-19 (cur) 1/1

McIndoe
19 cm / 7½"

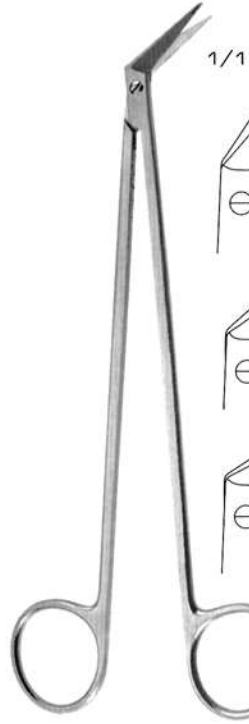
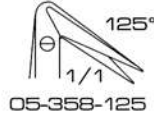
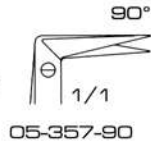
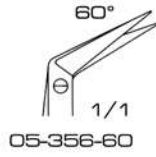
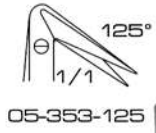
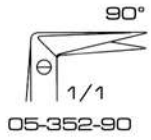

Potts-Smith
19 cm / 7½"

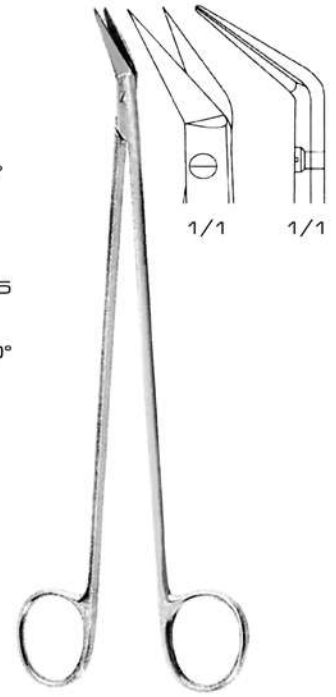
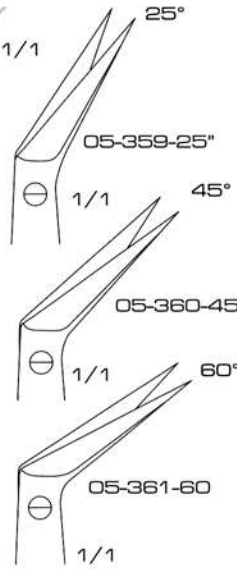

Potts-Smith
05-362-18
18 cm / 7"

Dietrich-Hegemann
16 cm / 6¼"

Dietrich-Hegemann
19 cm / 7½"

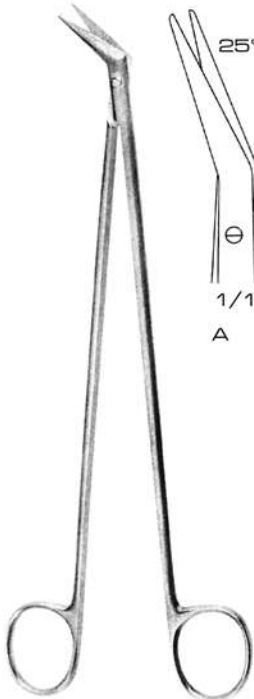

De Bakay

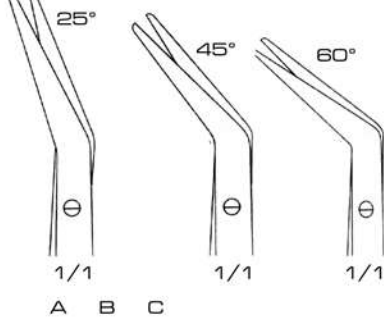

A B C

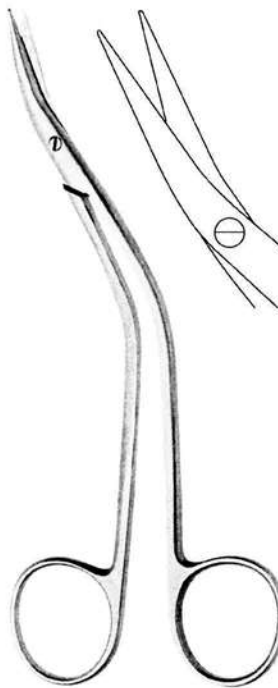

De Bakay
05-378-155
15.5 cm / 6"

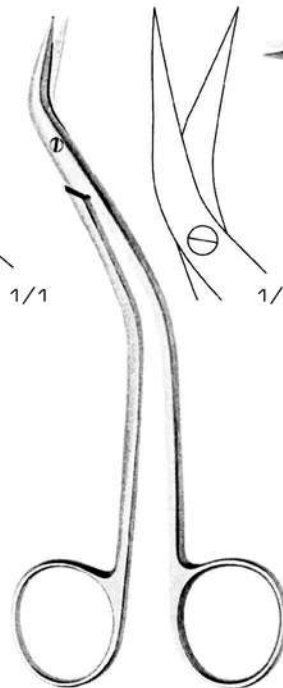

De Bakay
05-379-155
15.5 cm / 6"

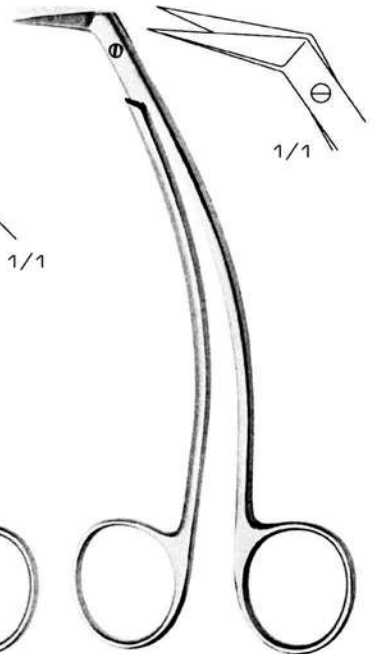

De Bakay
05-380-155
15.5 cm / 6"

- 17.5 cm / 6¾" 05-363-175 05-368-175 05-373-175
- 19.5 cm / 7¾" 05-364-195 05-369-195 05-374-195
- 21 cm / 8¼" 05-365-21 05-370-21 05-375-21
- 23 cm / 9" 05-366-23 05-371-23 05-376-23
- 28 cm / 11" 05-367-28 05-372-28 05-377-28

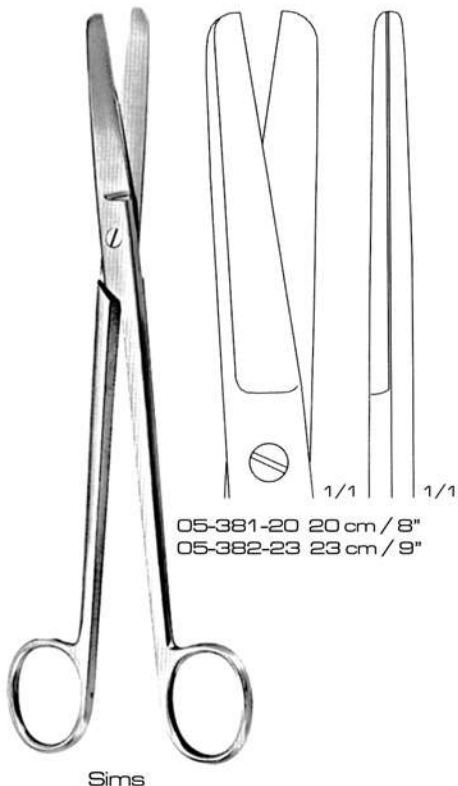

05-381-20 20 cm / 8"
05-382-23 23 cm / 9"

Sims

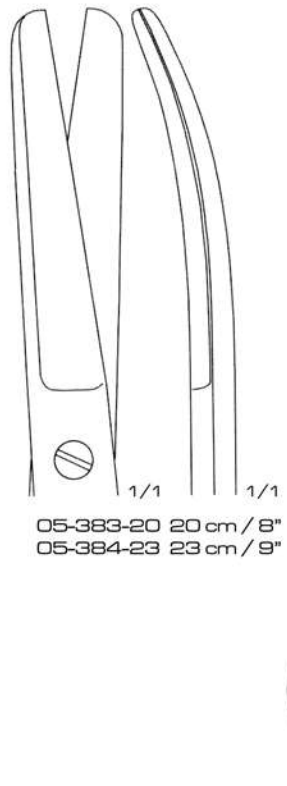

05-383-20 20 cm / 8"
05-384-23 23 cm / 9"

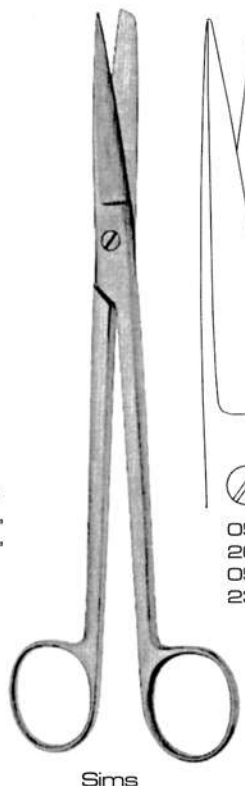

05-385-20 20 cm / 8"
05-386-23 23 cm / 9"

Sims

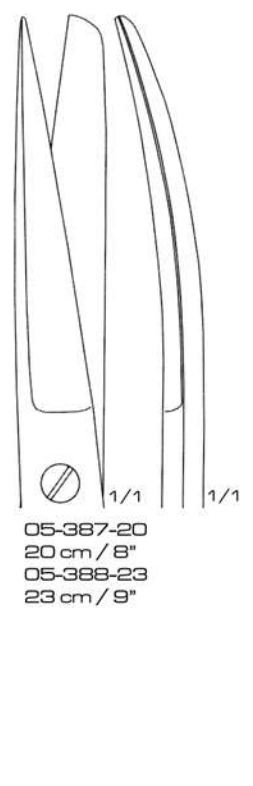

05-387-20 20 cm / 8"
05-388-23 23 cm / 9"



05-389-16 16 cm / 6 1/4"
05-390-175 17.5 cm / 7" (str.)
05-391-16 16 cm / 6 1/4"
05-392-175 17.5 cm / 7" (cur.)
05-393-16 16 cm / 6 1/4"
05-394-175 17.5 cm / 7" (str.)
05-395-16 16 cm / 6 1/4"
05-396-175 17.5 cm / 7" (cur.)

Doyen
16 cm / 6 1/4"



Kelly
05-397-16
16 cm / 6 1/4"



Kelly
05-398-16
16 cm / 6 1/4"



Wertheim
05-399-195
19.5 cm / 7 3/4"



Waldmann
05-400-18
18 cm / 7"



Braun-Stadler
05-401-145 14.5 cm / 5³/₄"
05-402-16 16 cm / 6¹/₄"
05-403-20 20 cm / 8"
05-404-22 22 cm / 8³/₄"



Mod. USA
05-405-105
10.5 cm / 4¹/₄"



Busch
05-406-16
16 cm / 6¹/₄"



Beebee
10.5 cm / 4¹/₄"



1/1 1/1

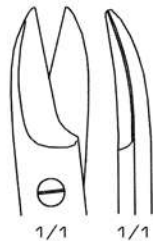

1/1 1/1

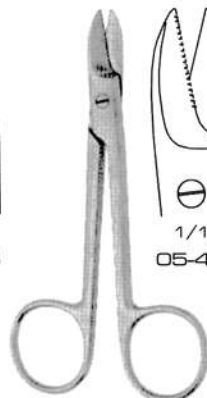

Beebee
10.5 cm / 4¹/₄"

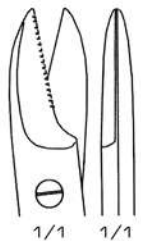

1/1 1/1

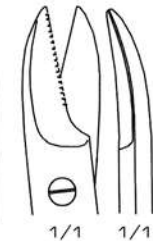

1/1 1/1

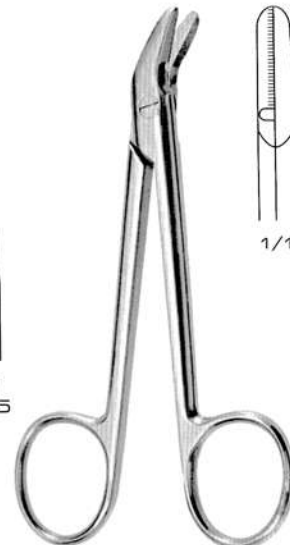

Universal
05-411-12
12 cm / 4³/₄"



1/1

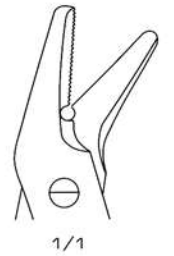

1/1

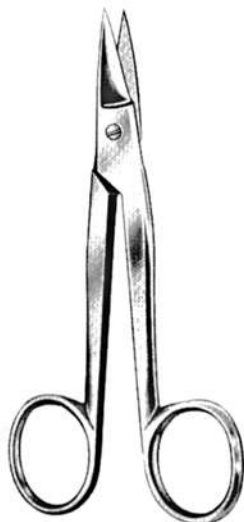

Crown
05-412-11
11 cm / 4¹/₄"



Crown
05-413-11
11 cm / 4¹/₄"



Fomon
05-414-13
13 cm / 4¹/₂"

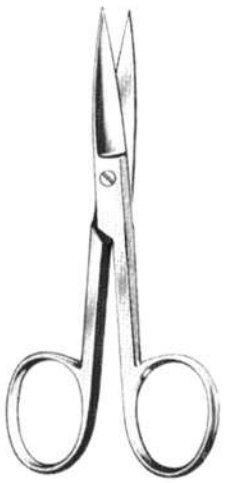

05-415-09
9 cm / 3½"
05-416-10
10 cm / 4"

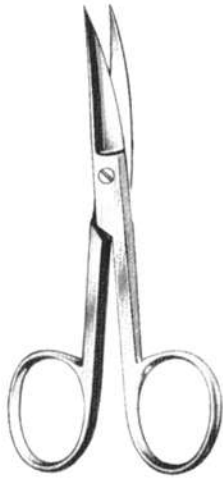

05-417-09
9 cm / 3½"
05-418-10
10 cm / 4"

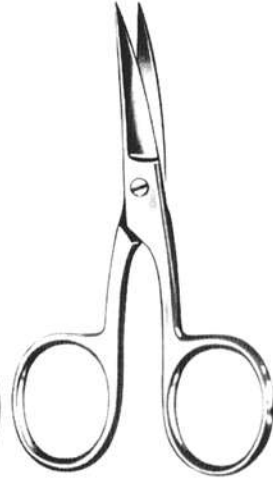

05-419-10
10 cm / 4"



05-420-10
10 cm / 4"
05-421-11
11 cm / 4¼"



05-422-10
10 cm / 4"
05-423-11
11 cm / 4¼"



05-424-10
10 cm / 4"

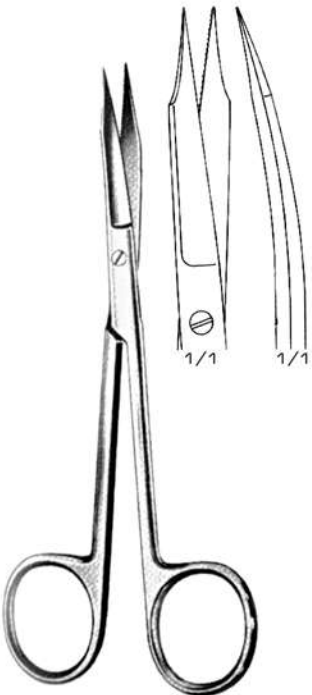

Goldmann-Fox
05-425-13
13 cm / 5"

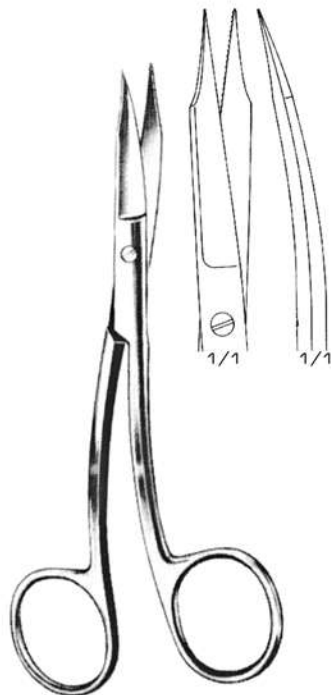

Goldmann-Fox
05-426-13
13 cm / 5"

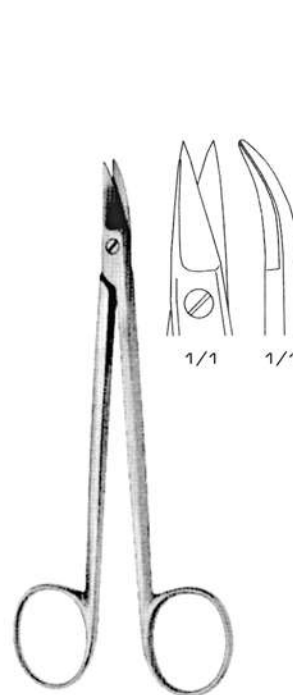

Quinby
05-427-125
12.5 cm / 4¾"

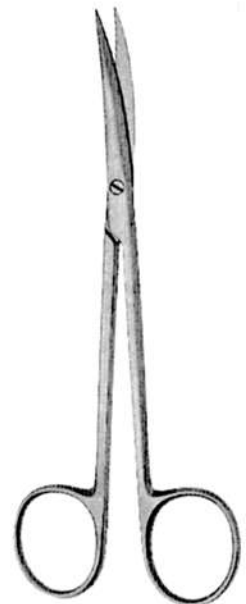

Sullivan
05-428-145
14.5 cm / 5¾"

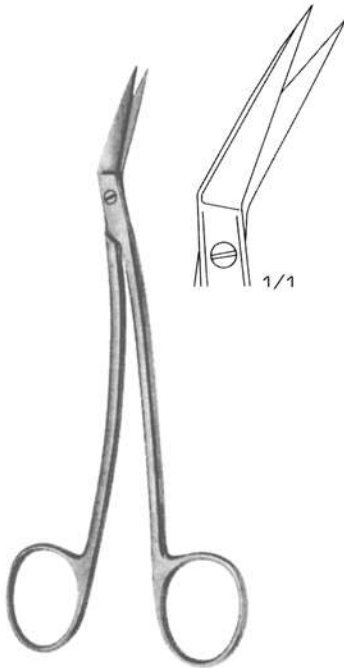

Locklin
05-429-165
16.5 cm / 6½"

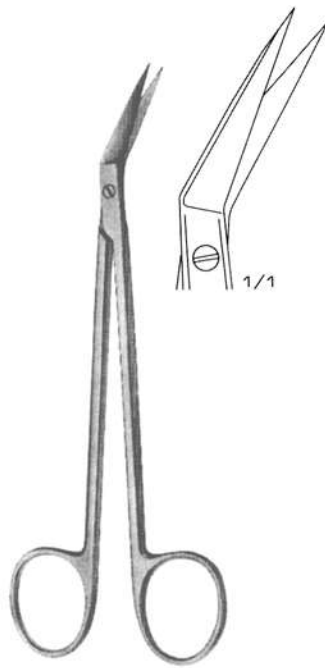

Locklin
05-430-165
16.5 cm / 6½"

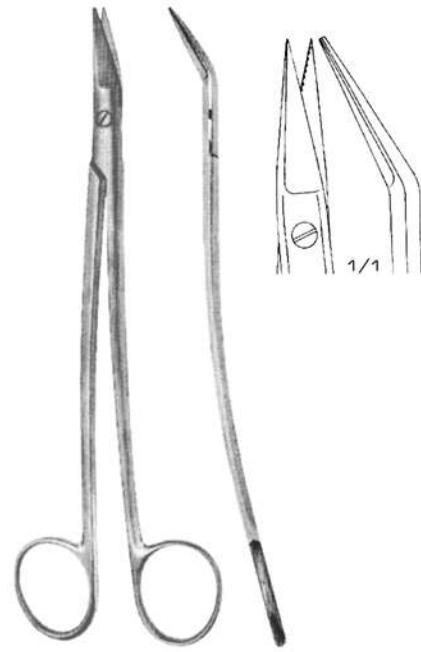

Dean
05-431-17
17 cm / 6¾"

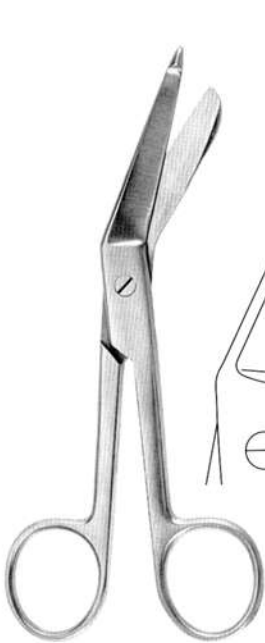

Lister
05-432-11 11 cm / 4¼"
05-433-14 14 cm / 5½"
05-434-18 18 cm / 7"
05-435-20 20 cm / 8"
05-436-23 23 cm / 9"



Lister
05-437-18 18 cm / 7"
05-438-21 21 cm / 8¼"



Lister-Excentric
05-439-16 16 cm / 6¼"
05-440-19 19 cm / 7½"

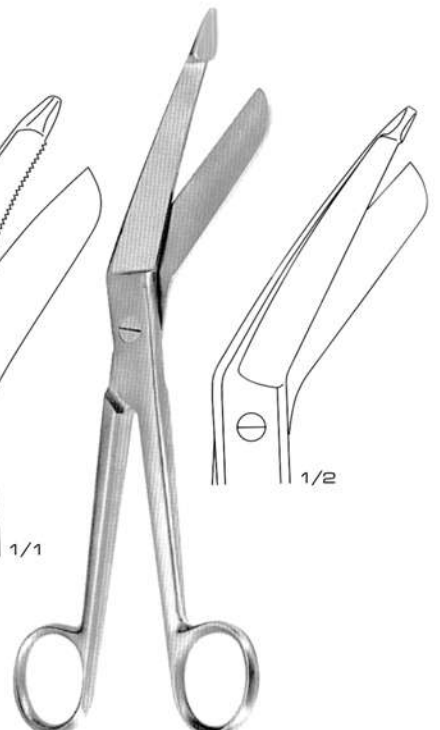

Bergmann
05-441-23
23 cm / 9"



Esmarch
05-442-18
18 cm / 7"
05-443-20
20 cm / 8"
05-444-23
23 cm / 9"

Bruns
05-445-24
24 cm / 9½"

Lange
05-446-18
18 cm / 7"

Lorenz
05-447-23
23 cm / 9"

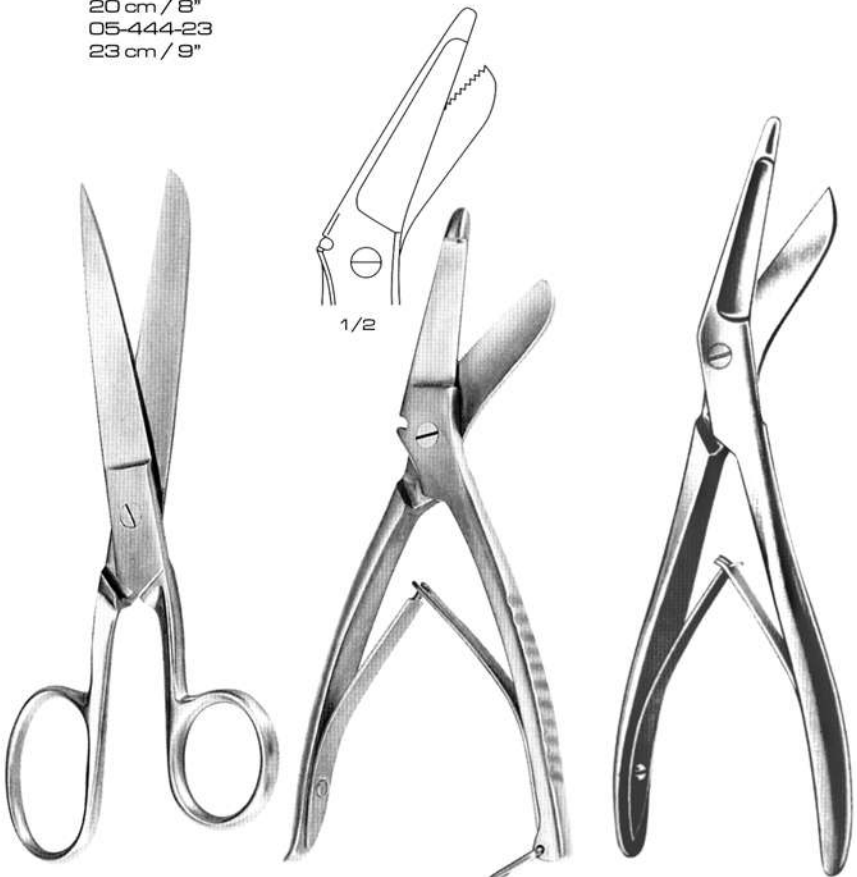

Smith (Mod. USA)
05-448-20 20 cm / 8"
05-449-23 23 cm / 9"

05-450-20
20 cm / 8"

Seutin
05-451-23
23 cm / 9"



Rings and nose tip are available in different colors

Universal
05-452-14
14 cm / 5½"
05-453-18
18 cm / 7"
(Available with & without
plastic nose tip)

Universal
05-454-14
14 cm / 5½"
(Available with & without
plastic nose tip)

Thumb Forceps



OGE
ORTHOGENT
ENGINEERING



Adson-Brown
05-455-12
12 cm / 4¾"

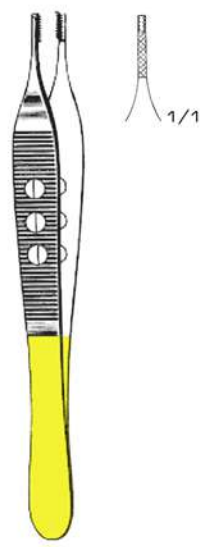

Adson-Brown
05-456-12
12 cm / 4¾"



Adson
1 x 2 Teeth

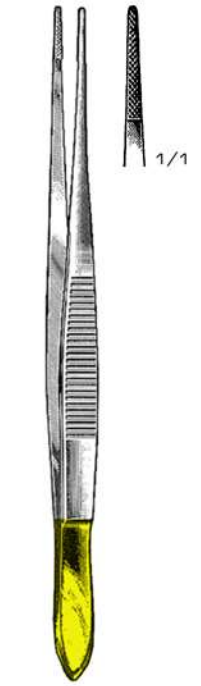
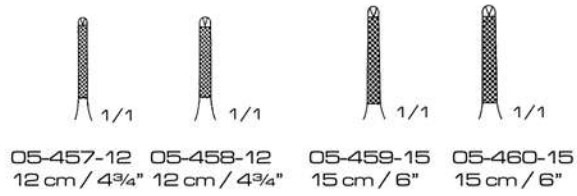

Cushing
05-461-18
18 cm / 7"



Adson
0.4 mm Serrations

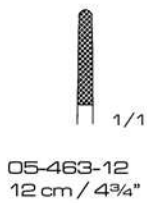
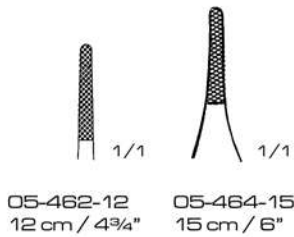

Standard
05-465-12 12 cm / 4¾"
05-466-14 14 cm / 5½"
05-467-16 16 cm / 6¼"
05-468-18 18 cm / 7"
05-469-20 20 cm / 8"
05-470-25 25 cm / 10"



Dehler
1 x 2 Teeth
0.4 mm Serrations

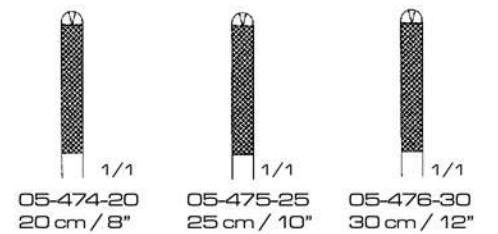
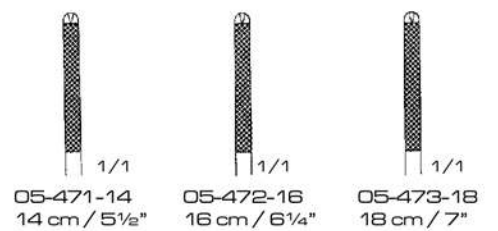



GOLD LINE

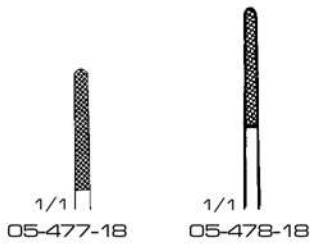

Cushing
18 cm / 7"



Williams
05-481-20
20 cm / 8"
3 x 4 Teeth



Evans
05-482-25
25 cm / 10"



Cushing Taylor
05-483-18
18 cm / 7"



Cushing Taylor
05-484-18
18 cm / 7"

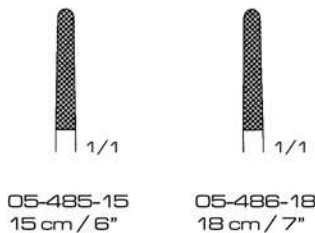

Potts-Smith

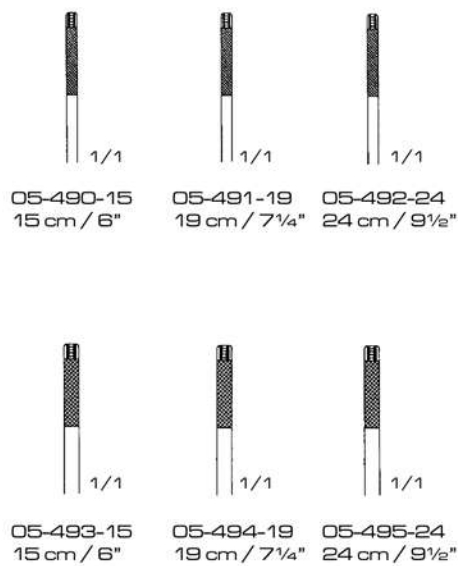

De Bakay



Gillies
05-496-15
15 cm / 6"
1 x 2 Teeth



McIndoe
05-497-15
15 cm / 6"



Gruenwald
05-498-185
18.5 cm / 7 1/4"



Ferris-Smith
05-499-17
17 cm / 5 3/4"
1 x 2 th

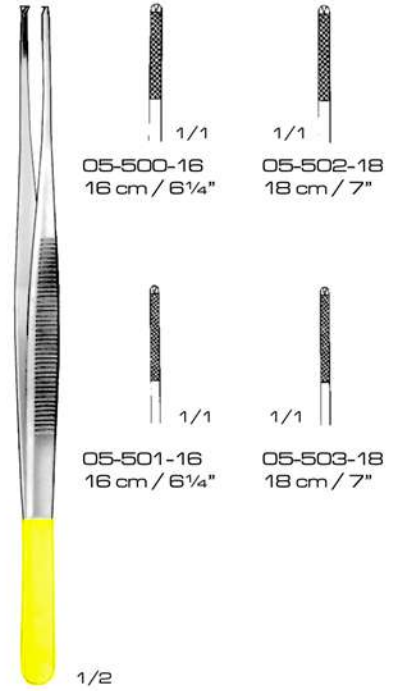

Semken
1 x 2 Teeth



Gerald
17 cm / 6 3/4"

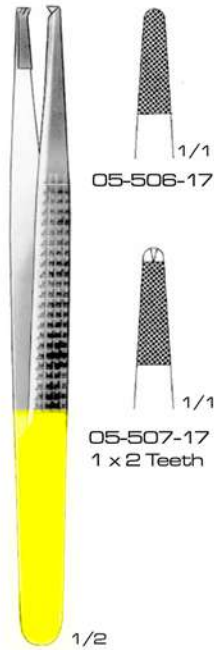

Bonney
17 cm / 6 3/4"



Skinner
23 cm / 9"
1 x 2 th

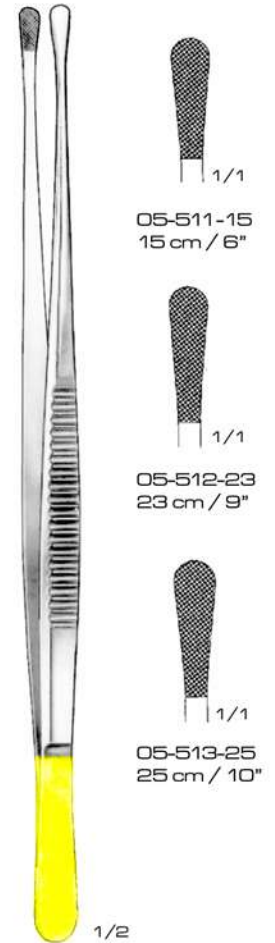
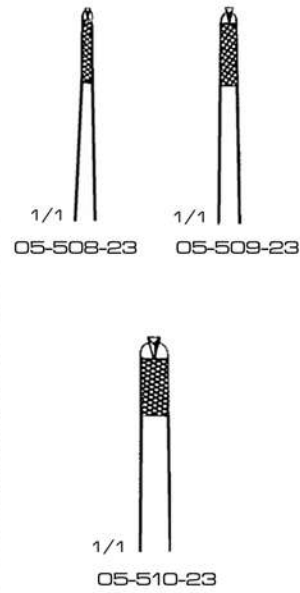

Wangenstein



Standard

- 05-514-105 10.5 cm / 4"
- 05-515-115 11.5 cm / 4½"
- 05-516-13 13 cm / 5"
- 05-517-14 14 cm / 5½"
- 05-518-15 15 cm / 6"
- 05-519-16 16 cm / 6¼"
- 05-520-18 18 cm / 7"
- 05-521-20 20 cm / 8"
- 05-522-25 25 cm / 10"
- 05-523-30 30 cm / 12"



Standard - Narrow

- 05-524-105 10.5 cm / 4"
- 05-525-115 11.5 cm / 4½"
- 05-526-13 13 cm / 5"
- 05-527-14 14 cm / 5½"
- 05-528-15 15 cm / 6"
- 05-529-16 16 cm / 6¼"
- 05-530-18 18 cm / 7"
- 05-531-20 20 cm / 8"
- 05-532-25 25 cm / 10"
- 05-533-30 30 cm / 12"



Mod. U.S.A.

- 05-534-12 12 cm / 4¾"
- 05-535-13 13 cm / 5"
- 05-536-14 14 cm / 5½"
- 05-537-15 15 cm / 6"
- 05-538-18 18 cm / 7"
- 05-539-20 20 cm / 8"
- 05-540-25 25 cm / 10"
- 05-541-30 30 cm / 12"



**Stille
Swedish Pattern**

- 05-542-11 11.0 cm / 4¼"
- 05-543-13 13 cm / 5"
- 05-544-15 15 cm / 6"



- 05-545-13 13 cm / 5"
 - 05-546-145 14.5 cm / 5¾"
- (Fine)



- Mod. USA**
- 05-547-12 12 cm / 4¾"
 - 05-548-13 13 cm / 5"
 - 05-549-145 14.5 cm / 5¾"
 - 05-550-15 15 cm / 6"
 - 05-551-18 18 cm / 7"
- (Fine)



- Semken**
- 05-552-125 12.5 cm / 5"
 - 05-553-15 15 cm / 6"



- Semken**
- 05-554-125 12.5 cm / 5"
 - 05-555-15 15 cm / 6"



05-556-105



05-557-105



- Iris**
- 05-558-105 10.5 cm / 4⅛"



- Potts-Smith**
- 05-559-18 18 cm / 7"
 - 05-560-21 21 cm / 8¼"
 - 05-561-25 25 cm / 10"



Cushing
05-562-175
17.5 cm / 6¾"



Cushing
05-563-18
18 cm / 7"



Cushing
05-564-18
18 cm / 7"
1 x 2 th



Brophy
05-565-20
20 cm / 8"

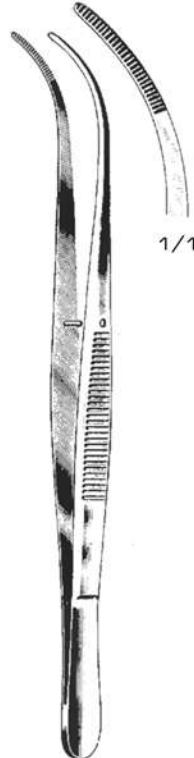

Brophy
05-566-20
20 cm / 8"



Brophy
05-567-20
20 cm / 8"
1 x 2 th

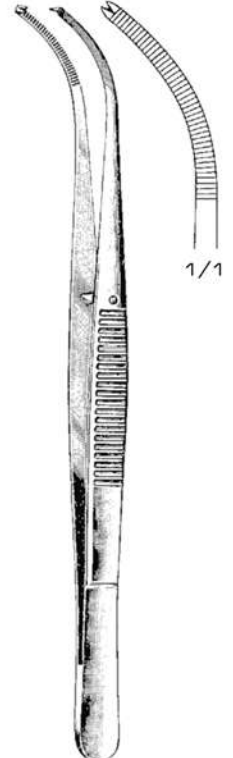

Brophy
05-568-20
20 cm / 8"
1 x 2 th



Gerald
05-569-18
18 cm / 7"



Gerald
05-570-18
18 cm / 7"

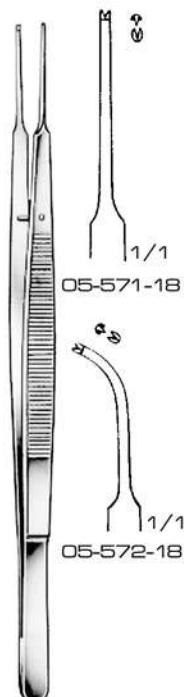

Gerald
18 cm / 7"
1 x 2 th



Taylor
05-573-175
17.5 cm / 6¾"



Taylor
05-574-175
17.5 cm / 6¾"

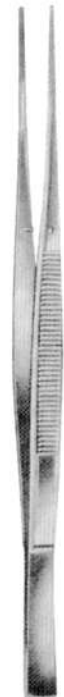

Taylor
05-575-175
17.5 cm / 6¾"



Taylor
05-576-185
18.5 cm / 7¼"



McIndoe
05-577-15
15 cm / 6"

↻ 1 x 2 th



Standard
 05-578-105 10.5 cm / 4"
 05-579-115 11.5 cm / 4½"
 05-580-13 13 cm / 5"
 05-581-14 14 cm / 5½"
 05-582-15 15 cm / 6"
 05-583-16 16 cm / 6¼"
 05-584-18 18 cm / 7"
 05-585-20 20 cm / 8"
 05-586-25 25 cm / 10"
 05-587-30 30 cm / 12"

↻ 1 x 2 th



Narrow
 05-588-105 10.5 cm / 4"
 05-589-115 11.5 cm / 4½"
 05-590-13 13 cm / 5"
 05-591-14 14 cm / 5½"
 05-592-15 15 cm / 6"
 05-593-16 16 cm / 6¼"
 05-594-18 18 cm / 7"
 05-595-20 20 cm / 8"
 05-596-25 25 cm / 10"
 05-597-30 30 cm / 12"

↻ 1 x 2 th



Fine
 05-598-105 10.5 cm / 4"
 05-599-115 11.5 cm / 4½"
 05-600-13 13 cm / 5"
 05-601-14 14 cm / 5½"
 05-602-15 15 cm / 6"
 05-603-16 16 cm / 6¼"
 05-604-18 18 cm / 7"
 05-605-20 20 cm / 8"
 05-606-25 25 cm / 10"
 05-607-30 30 cm / 12"

↻ 2 x 3 th



Standard
 05-608-105 10.5 cm / 4"
 05-609-115 11.5 cm / 4½"
 05-610-13 13 cm / 5"
 05-611-145 14.5 cm / 5¾"
 05-612-15 15 cm / 6"
 05-613-16 16 cm / 6¼"
 05-614-18 18 cm / 7"
 05-615-20 20 cm / 8"
 05-616-25 25 cm / 10"
 05-617-30 30 cm / 12"

↻ 1 x 2 th



Standard - Fine
 05-618-105 10.5 cm / 4"
 05-619-115 11.5 cm / 4½"
 05-620-13 13 cm / 5"
 05-621-145 14.5 cm / 5¾"
 05-622-15 15 cm / 6"
 05-623-16 16 cm / 6¼"
 05-624-18 18 cm / 7"
 05-625-20 20 cm / 8"
 05-626-25 25 cm / 10"
 05-627-30 30 cm / 12"

↻ 2 x 3 th



Standard
 05-628-12 12 cm / 4¾"
 05-629-13 13 cm / 5"
 05-630-145 14.5 cm / 5¾"
 05-631-15 15 cm / 6"
 05-632-18 18 cm / 7"
 05-633-20 20 cm / 8"
 05-634-25 25 cm / 10"
 05-635-30 30 cm / 12"

↻ 1 x 2 th



Mod. U.S.A.
 05-636-105 10.5 cm / 4"
 05-637-115 11.5 cm / 4½"
 05-638-13 13 cm / 5"
 05-639-14 14 cm / 5½"
 05-640-15 15 cm / 6"
 05-641-16 16 cm / 6¼"
 05-642-18 18 cm / 7"
 05-643-20 20 cm / 8"
 05-644-25 25 cm / 10"
 05-645-30 30 cm / 12"

3 x 4 th



05-646-11 11.0 cm / 4¼"
 05-647-13 13 cm / 5"
 05-648-15 15 cm / 6"

4 x 5 th



05-649-13 13 cm / 5"
 05-650-145 14.5 cm / 5¾"
 05-651-16 16 cm / 6¼"

↻ 1 x 2 th



05-654-105 10.5 cm / 4" (str.)

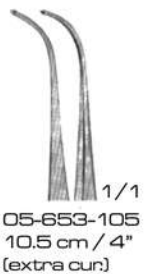
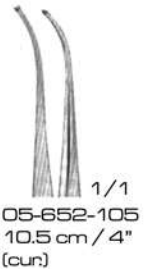

↻ 1 x 2 th



Potts-Smith
05-655-18
18 cm / 7"

05-656-21
21 cm / 8¼"

05-657-25
25 cm / 10"

↻ 1 x 2 th



Semken
05-658-125
12.5 cm / 5"

05-659-155
15.5 cm / 6"

↻ 1 x 2 th

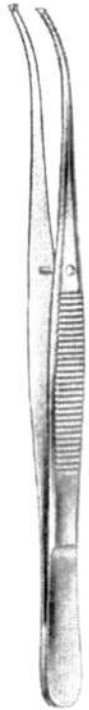

Semken
05-660-125
12.5 cm / 5"

05-661-155
15.5 cm / 6"

↻ 1 x 2 th



Stille
05-662-15
15 cm / 6"



05-663-16
16 cm / 6¼"

05-664-18
18 cm / 7"

↻ 1 x 2 th



Cushing
05-665-175
17.5 cm / 6¾"

↻ 1 x 2 th



Gillies
05-666-15
15 cm / 6"

1/1



Select
05-667-15
15 cm / 6"

1/1

05-668-18
18 cm / 7"

05-669-20
20 cm / 8"



Select
05-670-15
15 cm / 6"

1/1

05-671-18
18 cm / 7"

05-672-20
20 cm / 8"



05-673-18

1/1

05-674-18

05-674-18

Ferris-Smith
18 cm / 7"

1/1

2 x 3 th

1 x 2 th



Ramsay
05-675-18
18 cm / 7"

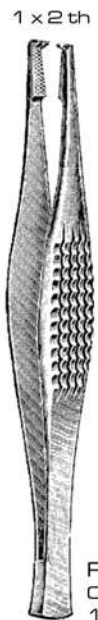

Ramsay
05-676-18
18 cm / 7"

1 x 2 th



Hudson (Ewald)
05-677-12
12 cm / 4¾"



1/1



Hudson (Ewald)
05-678-12
12 cm / 4¾"

1 x 2 th

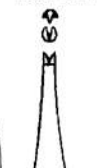

1/1

TISSUE FORCEPS



1 x 2 th



Taylor
05-679-175
17.5 cm / 6 3/4"

1 x 2 th



Taylor
05-680-175
17.5 cm / 6 3/4"

1 x 2 th



Taylor
05-681-175
17.5 cm / 6 3/4"

1 x 2 th



Taylor
05-682-175
17.5 cm / 6 3/4"



Adson
05-683-12
12 cm / 4 3/4"



Adson
05-684-12
12 cm / 4 3/4"

1 x 2 th

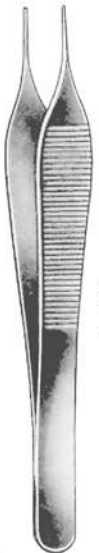

Micro-Adson
05-685-12
12 cm / 4 3/4"



Micro-Adson
05-686-12
12 cm / 4 3/4"



Micro-Adson
05-687-15
15 cm / 6"



Micro-Adson
05-688-15
15 cm / 6"



Adson Brown
05-689-12
12 cm / 4 3/4"



Adson Brown
05-690-12
12 cm / 4 3/4"



Adson
05-691-12
12 cm / 4 3/4"

1 x 2 th



Adson
05-692-12
12 cm / 4 3/4"



Adson Brown
05-693-12
12 cm / 4 3/4"



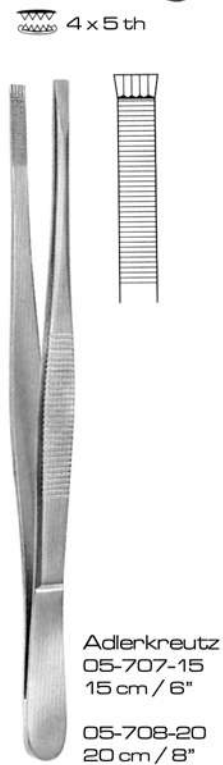
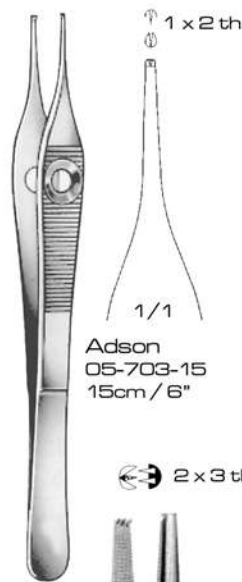
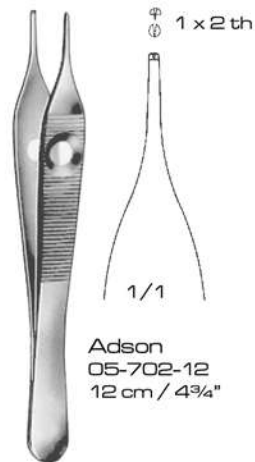
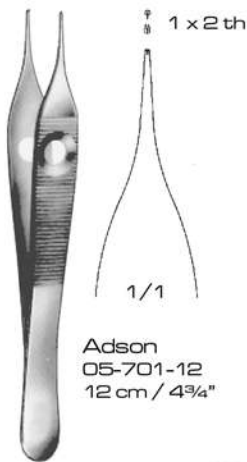
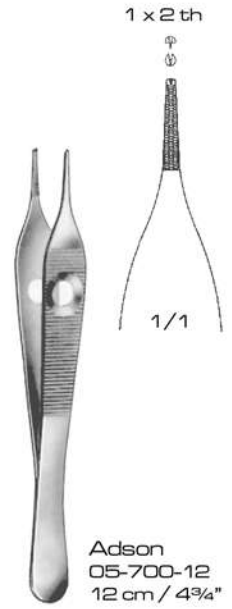
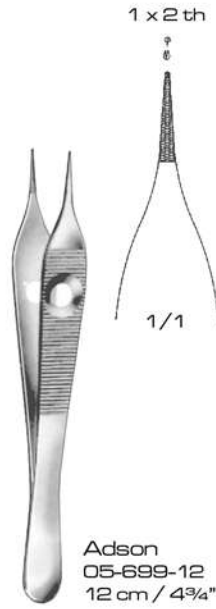
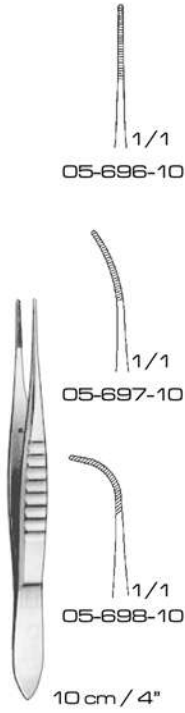
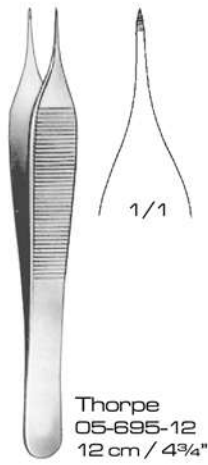
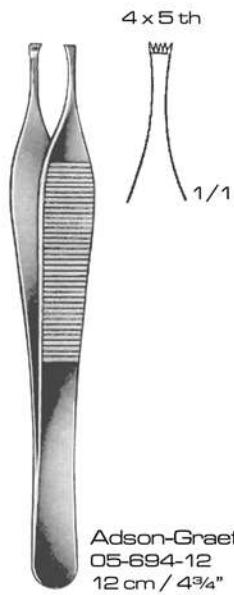



Mayo-Russian
05-714-23
23 cm / 9"



Singley-Tuttle
05-715-23
23 cm / 9"



Nelson
05-716-23
23 cm / 9"

1 x 2 th

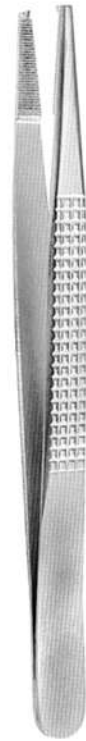

Bonney
05-717-18
18 cm / 7"

2 x 3 th



Bonney
05-718-18
18 cm / 7"



Fig.1
05-719-12
12 cm / 4 3/4"



Fig.2
05-720-12
12 cm / 4 3/4"



Fig.3
05-721-12
12 cm / 4 3/4"



Fig.4
05-722-11
11 cm / 4 3/8"



Fig.5
05-723-11
11 cm / 4 3/8"



Fig.5a
05-724-11
11 cm / 4 3/8"



Fig.5-45°
05-725-105
10.5 cm / 4 1/8"



Fig.5-90°
05-726-105
10.5 cm / 4 1/8"



Fig.7
05-727-105
10.5 cm / 4 1/8"



Feichenfeld
05-728-75
7.5 cm / 3"

05-729-9
9 cm / 3½"

05-730-115
11.5 cm / 4½"



Hunter
05-731-10.5
10.5 cm / 4¼"



Hunter
05-732-10.5
10.5 cm / 4¼"



05-733-8
8 cm / 3¼"

05-734-9
9 cm / 3½"

05-735-105
10.5 cm / 4¼"

05-736-115
11.5 cm / 4½"

05-737-13
13 cm / 5"



05-738-8
8 cm / 3¼"

05-739-9
9 cm / 3½"

05-740-105
10.5 cm / 4¼"

05-741-115
11.5 cm / 4½"

05-742-13
13 cm / 5"

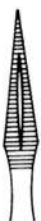

05-743-135

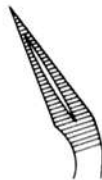

05-744-135



05-746-135



05-745-135

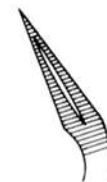

05-747-135



De Bakey
15 cm / 6" 05-751-15 05-756-15 05-761-15 05-766-15
16 cm / 6½" 05-752-16 05-757-16 05-762-16 05-767-16
20 cm / 8" 05-753-20 05-758-20 02-763-20 05-768-20
24 cm / 9½" 05-754-24 05-759-24 05-764-24 05-769-24
30 cm / 12" 05-755-30 05-760-30 05-765-30 05-770-30

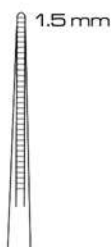

1.5 mm

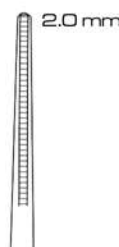

2.0 mm

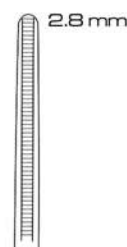

2.8 mm

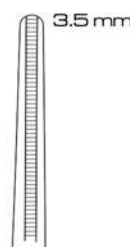

3.5 mm



Stieglitz
13.5 cm / 5½"

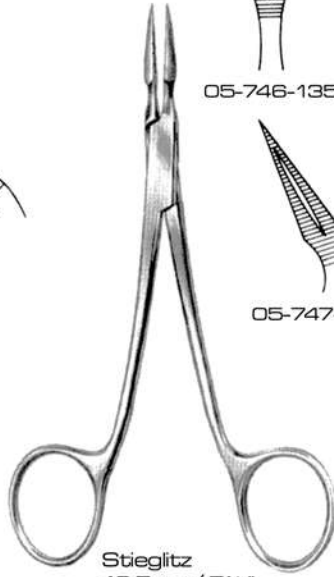

Stieglitz
13.5 cm / 5½"

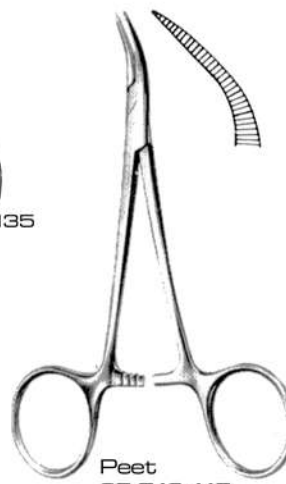

Peet
05-748-115
11.5 cm / 4½"



05-749-15

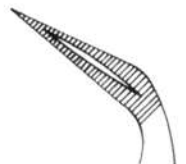

05-750-15



Ralk
15 cm / 6"

*Needle Holders,
Haemostatic Forceps & Clamps*

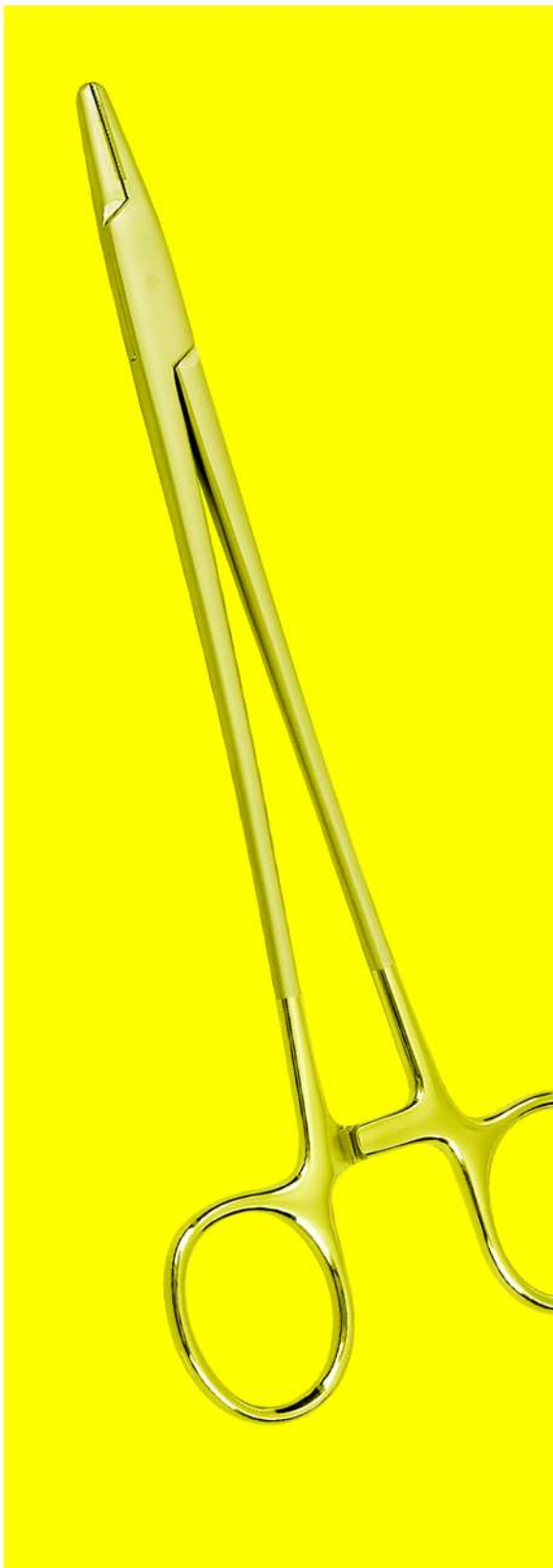

OGE
ORTHOGENT
ENGINEERING

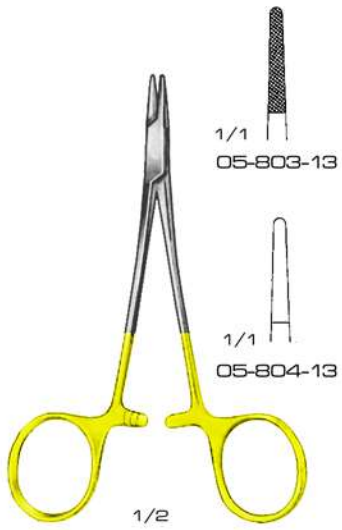

Halsey
13 cm / 5 1/8"

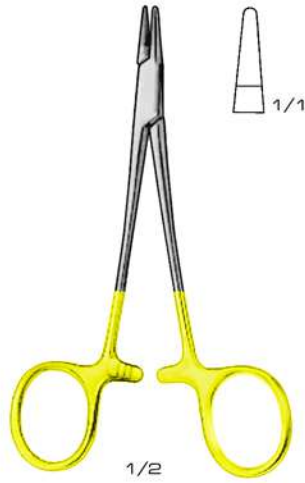

Webster
05-805-13
13 cm / 5 1/8"



Derf
05-806-12
12 cm / 4 3/4"

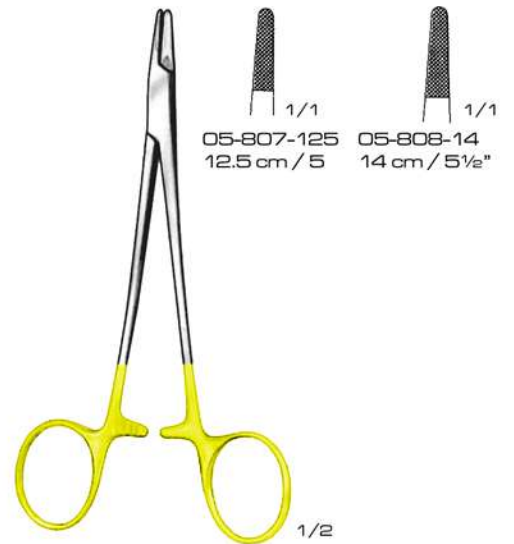

Hegar-Baumgartner

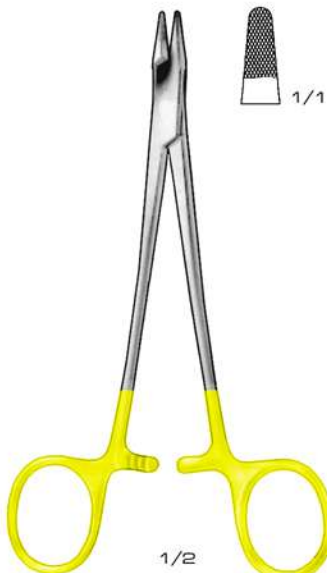

05-809-15
15 cm / 6"



Barry Sternal
05-810-15
15 cm / 6"

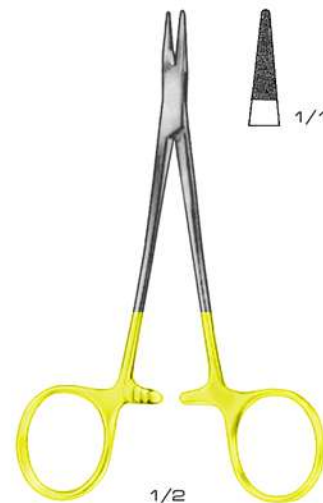

Converse
05-811-125
12.5 cm / 5"

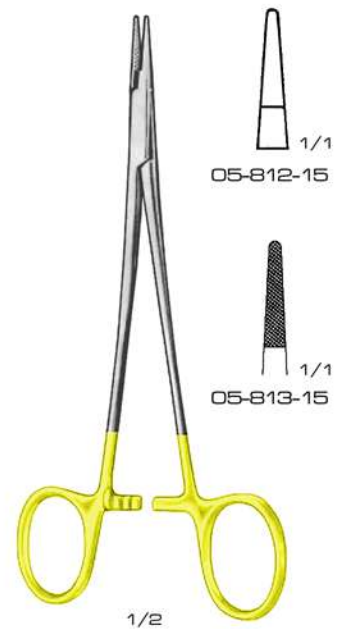

Chile-Wood
15 cm / 6"



GOLD LINE

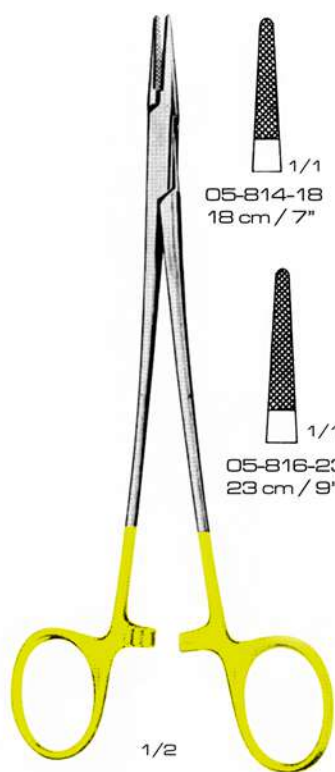

Crile-Wood

05-814-18
18 cm / 7"

05-815-20
20 cm / 8"

05-816-23
23 cm / 9"

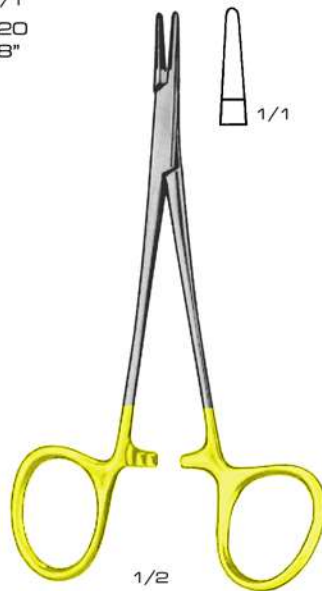

Nivert
05-817-13
13 cm / 5"



New Orleans
05-818-18
18 cm / 7"

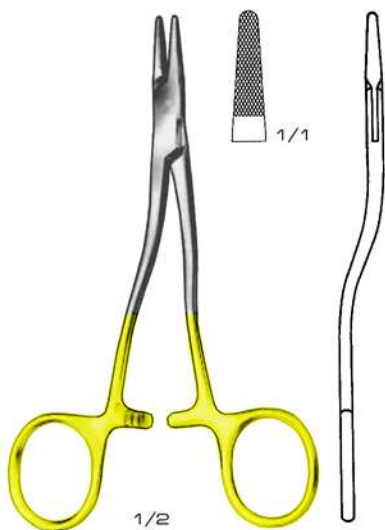

Kilner
05-819-135
13.5 cm / 5 1/4"

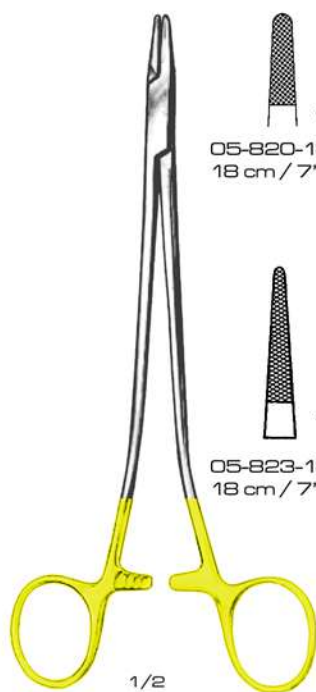

Sarot

05-820-18 18 cm / 7" 05-821-20 20 cm / 8" 05-822-26 26 cm / 10 1/4"

05-823-18 18 cm / 7" 05-824-22 22 cm / 8 3/4" 05-825-27 27 cm / 10 3/4"

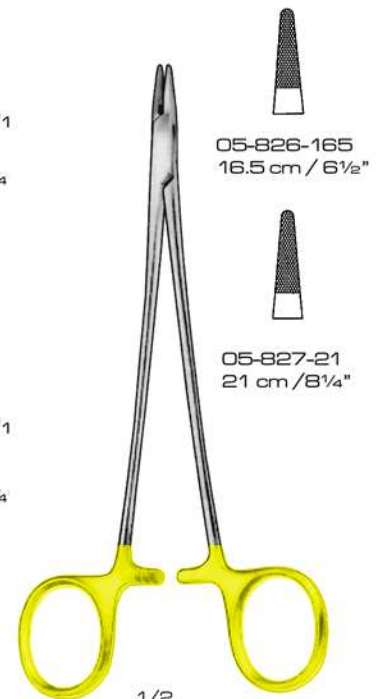

De-Bakey

05-826-165
16.5 cm / 6 1/2"

05-827-21
21 cm / 8 1/4"

GOLD LINE

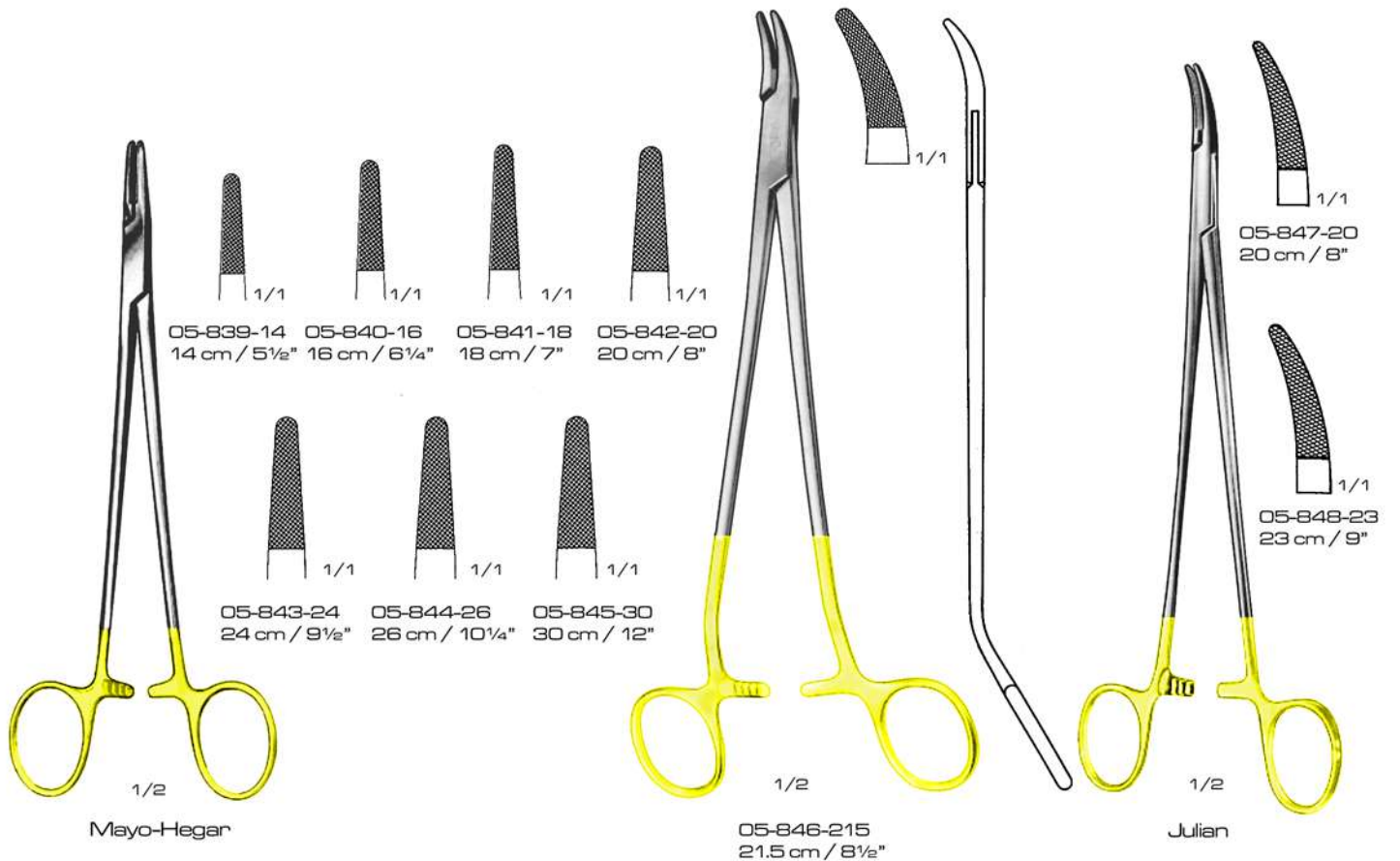
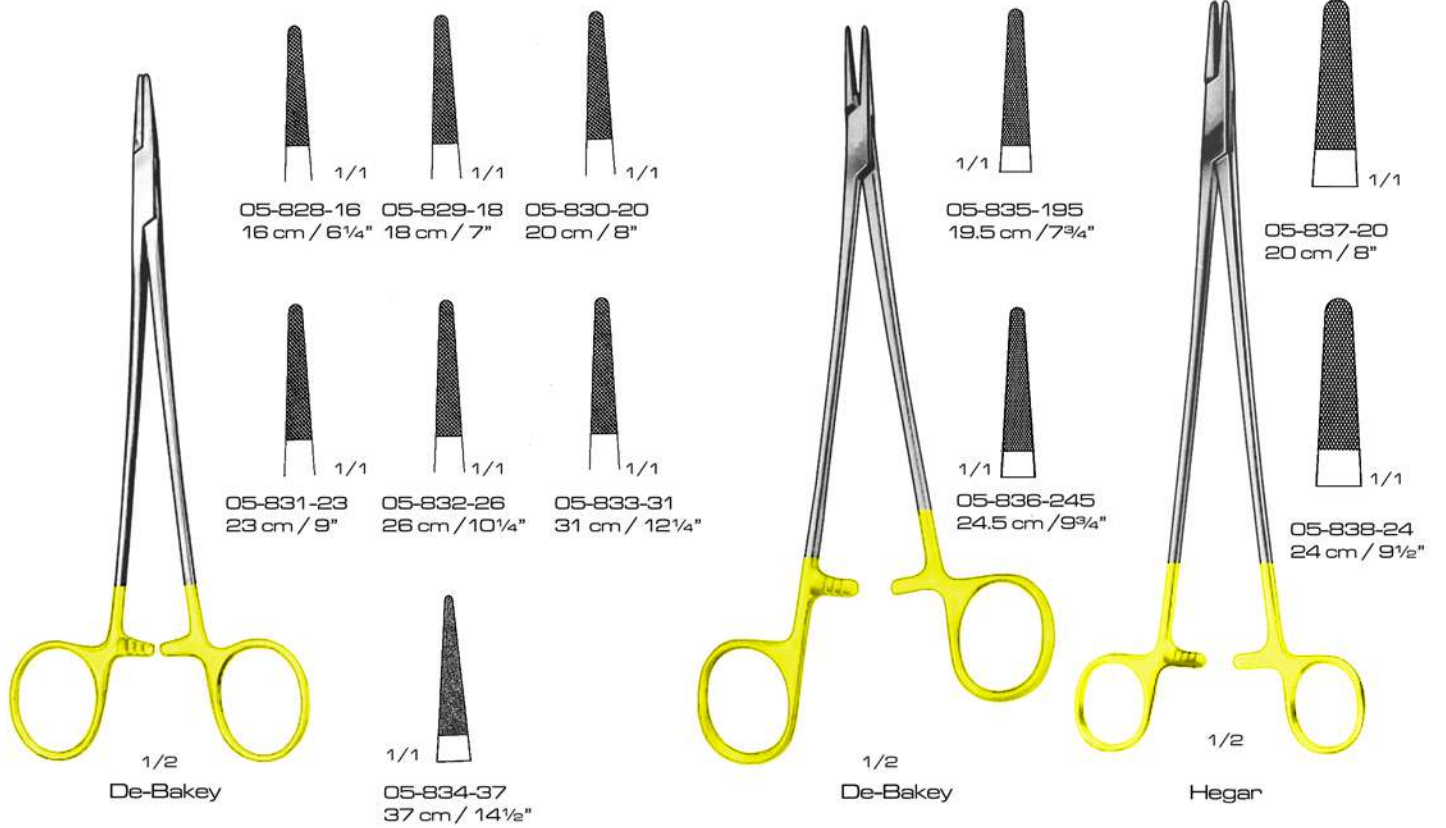

NEEDLE HOLDERS WITH TUNGSTEN CARBIDE INSERTS



GOLD LINE

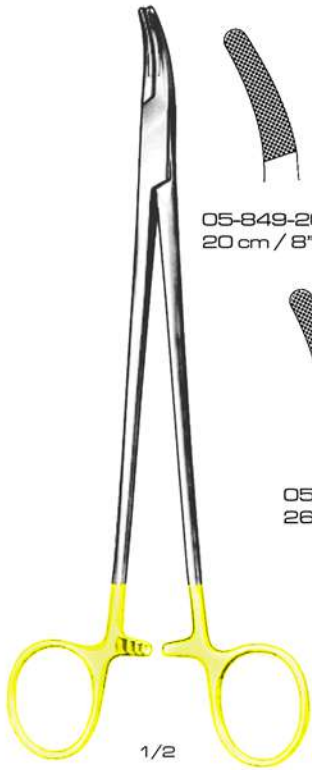

Mayo-Hegar (Heaney)

05-849-20
20 cm / 8"

05-850-24
24 cm / 9½"

05-851-26
26 cm / 10¼"

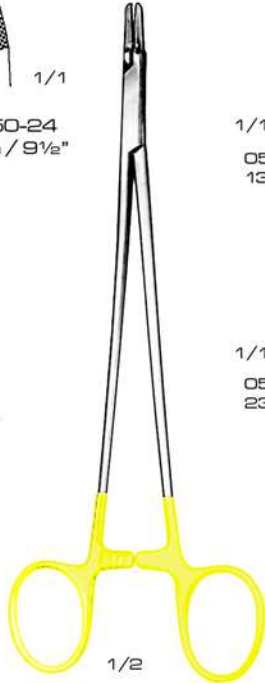

Ryder

05-852-13
13 cm / 5¼"

05-853-15
15 cm / 6"

05-854-18
18 cm / 7"

05-855-20
20 cm / 8"

05-856-23
23 cm / 9"

05-857-26
26 cm / 10¼"

05-858-13
13 cm / 5¼"

05-859-15
15 cm / 6"

05-860-18
18 cm / 7"

05-861-20
20 cm / 8"

05-862-23
23 cm / 9"

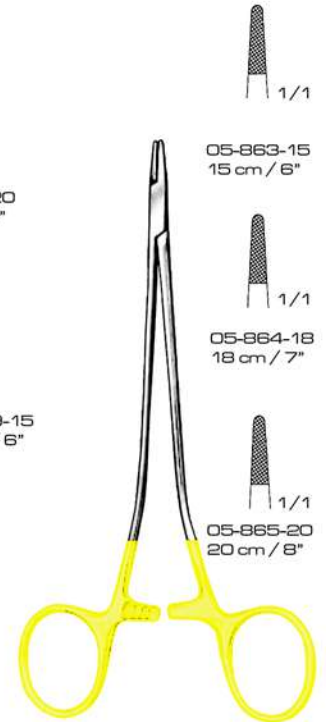

1/2

1/2

05-863-15
15 cm / 6"

05-864-18
18 cm / 7"

05-865-20
20 cm / 8"

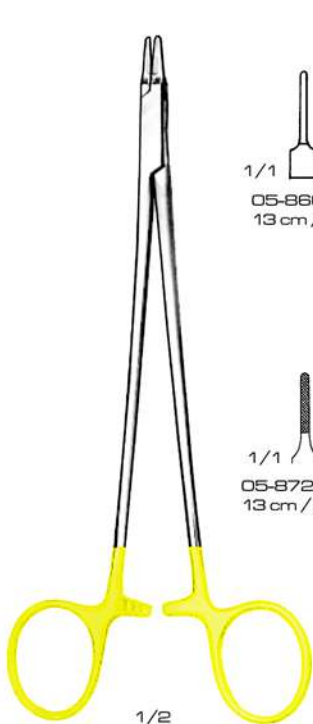

Ryder-Vascular

05-866-13
13 cm / 5¼"

05-867-15
15 cm / 6"

05-868-18
18 cm / 7"

05-869-20
20 cm / 8"

05-870-23
23 cm / 9"

05-871-26
26 cm / 10¼"

05-872-13
13 cm / 5¼"

05-873-15
15 cm / 6"

05-874-18
18 cm / 7"

05-875-20
20 cm / 8"







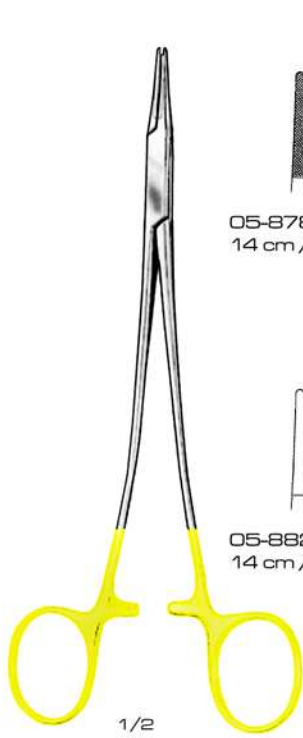

05-876-23
23 cm / 9"

05-877-26
26 cm / 10¼"

1/2







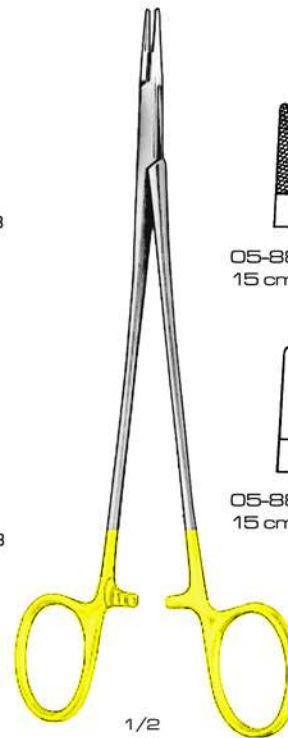

Hegar-Vascular

- | | | | |
|--|--|--|--|
| 
1/1 | 
1/1 | 
1/1 | 
1/1 |
| 05-878-14
14 cm / 5½" | 05-879-18
18 cm / 7" | 05-880-20
20 cm / 8" | 05-881-23
23 cm / 9" |
| 
1/1 | 
1/1 | 
1/1 | 
1/1 |
| 05-882-14
14 cm / 5½" | 05-883-18
18 cm / 7" | 05-884-20
20 cm / 8" | 05-885-23
23 cm / 9" |



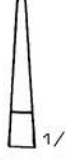

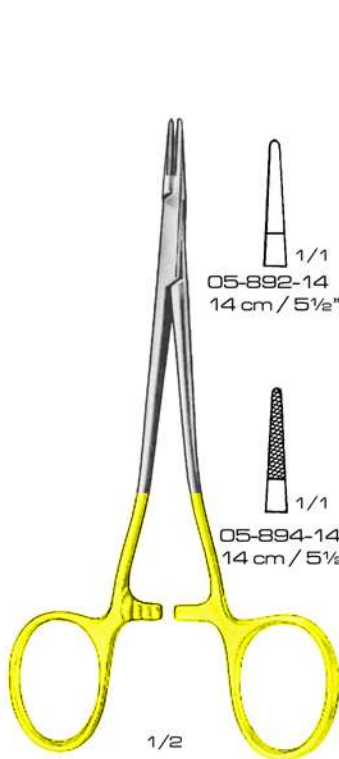

Micro-Slim

- | | | |
|--|--|--|
| 
1/1 | 
1/1 | 
1/1 |
| 05-886-15
15 cm / 6" | 05-887-18
18 cm / 7" | 05-888-20
20 cm / 8" |
| 
1/1 | 
1/1 | 
1/1 |
| 05-889-15
15 cm / 6" | 05-890-18
18 cm / 7" | 05-891-20
20 cm / 8" |





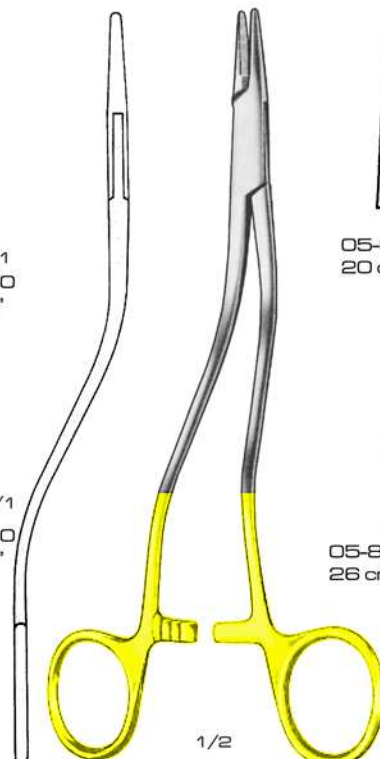

Intracardiac

- | | |
|--|--|
| 
1/1 | 
1/1 |
| 05-892-14
14 cm / 5½" | 05-893-20
20 cm / 8" |
| 
1/1 | 
1/1 |
| 05-894-14
14 cm / 5½" | 05-895-20
20 cm / 8" |



Wertheim

- | | |
|---|--|
| 
1/1 | 
1/1 |
| 05-896-20
20 cm / 8" | 05-897-24
24 cm / 9½" |
| 
1/1 | 
1/1 |
| 05-898-26
26 cm / 10¼" | 05-899-30
30 cm / 12" |

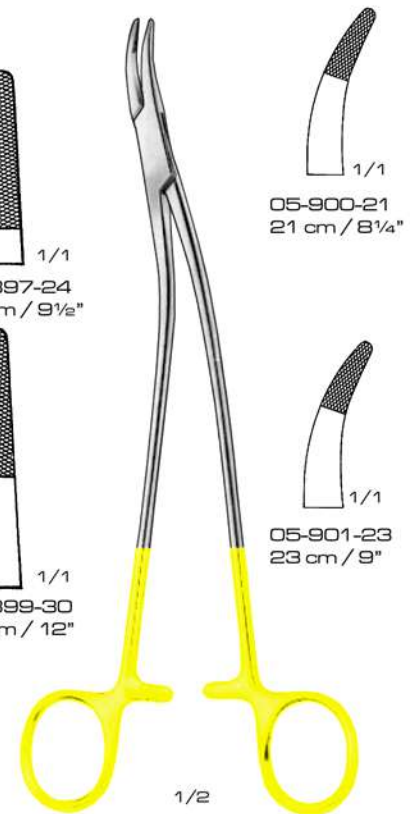

Stratte

- | |
|--|
| 
1/1 |
| 05-900-21
21 cm / 8¼" |
| 
1/1 |
| 05-901-23
23 cm / 9" |

GOLD LINE

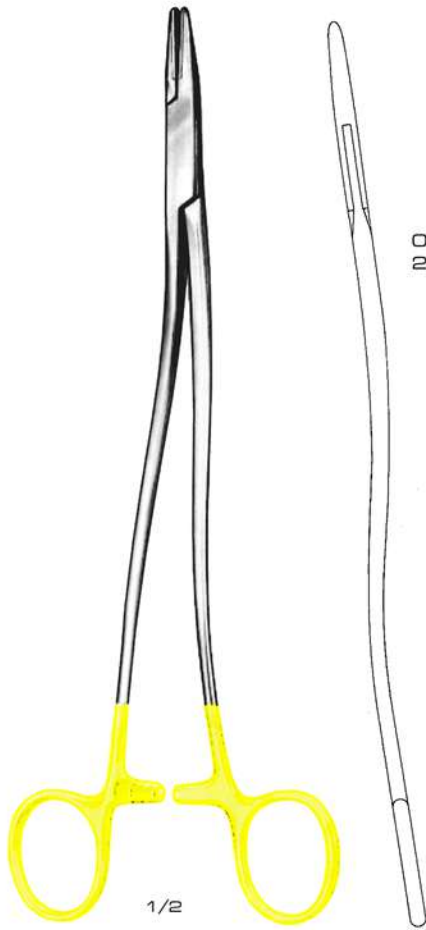

1/2
Bozemann

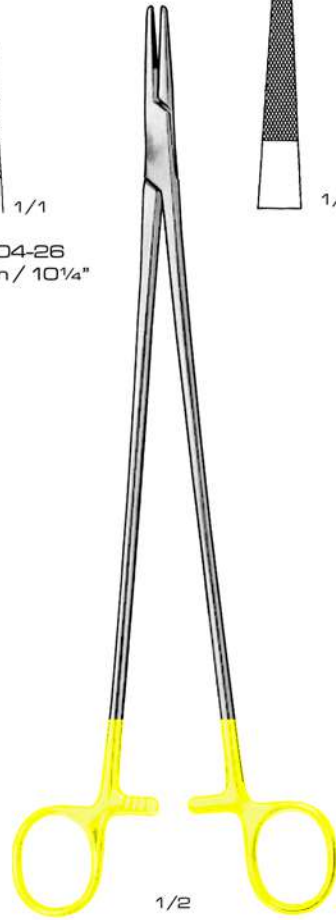
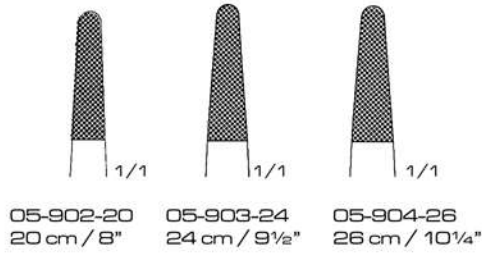

1/2
Wangenstein
05-905-27
27 cm / 10½"

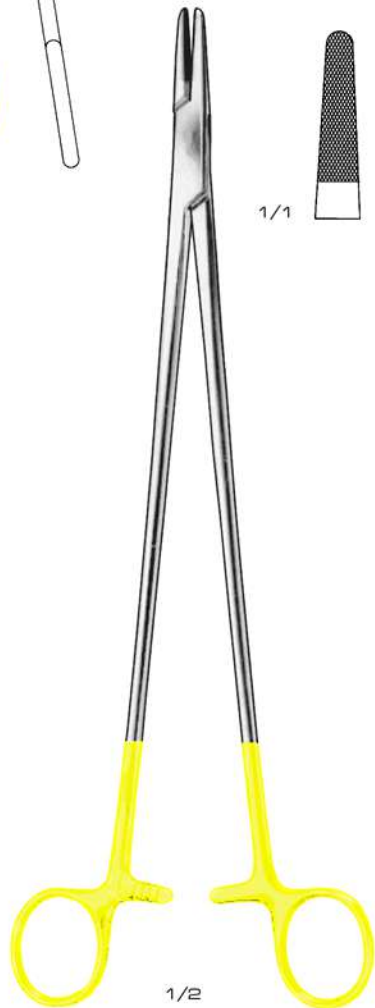

1/2
Masson
05-906-27
27 cm / 10½"

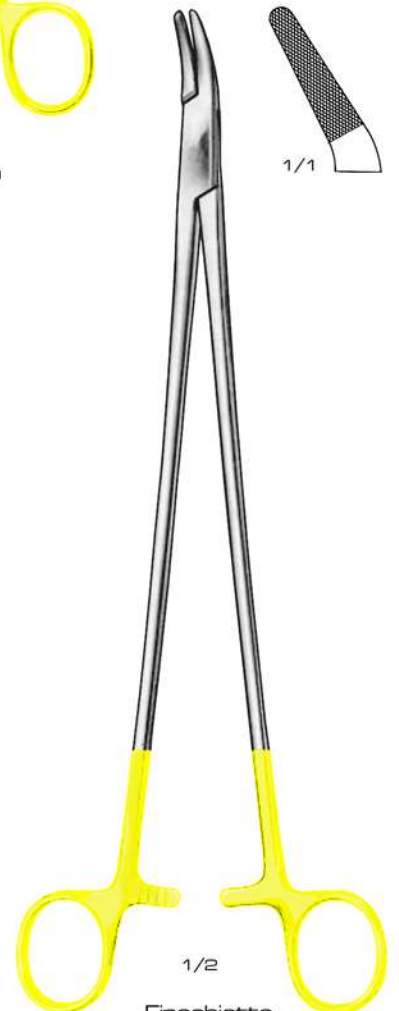

1/2
Finochietto
05-907-28
27 cm / 10½"



Naunton-Morgan
05-908-26
26 cm / 10¹/₄"

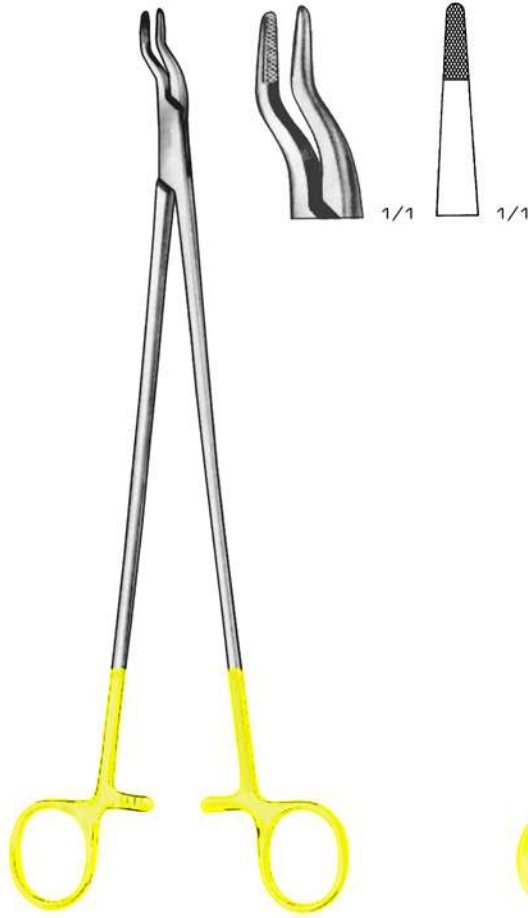

05-909-275
27.5 cm / 10³/₄"

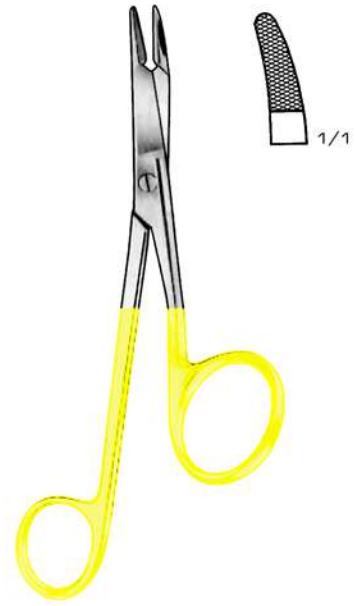

Gillies
05-910-16
16 cm / 6¹/₄"



Olsen-Hegar
12 cm / 12³/₄"



Olsen-Hegar

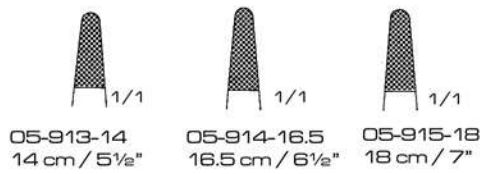

05-913-14
14 cm / 5¹/₂"

05-914-16.5
16.5 cm / 6¹/₂"

05-915-18
18 cm / 7"

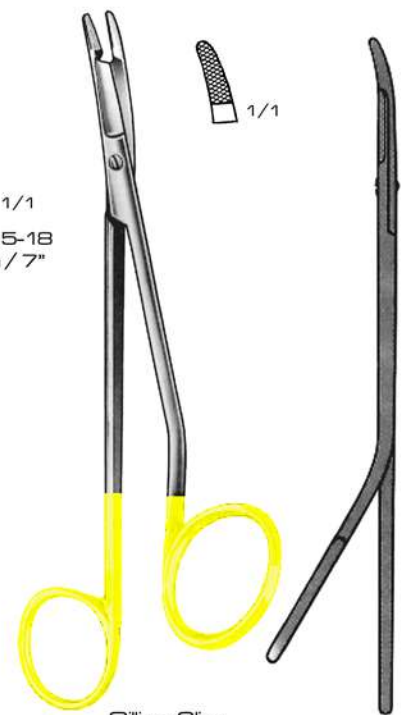

Gillies-Slim
05-916-14
14 cm / 5¹/₂"



GOLD LINE

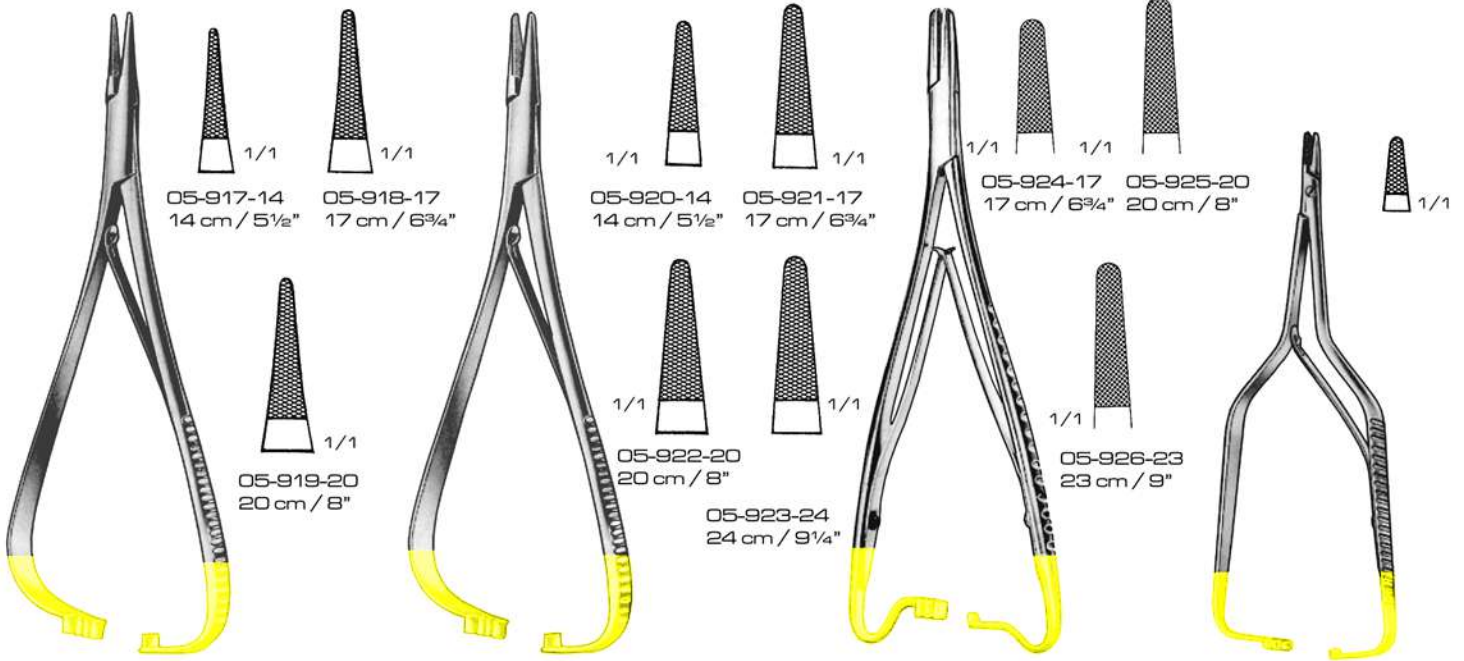

Mathieu-Kocher

Mathieu

Mathieu

Boynton
05-927-12
12 cm / 4¾"

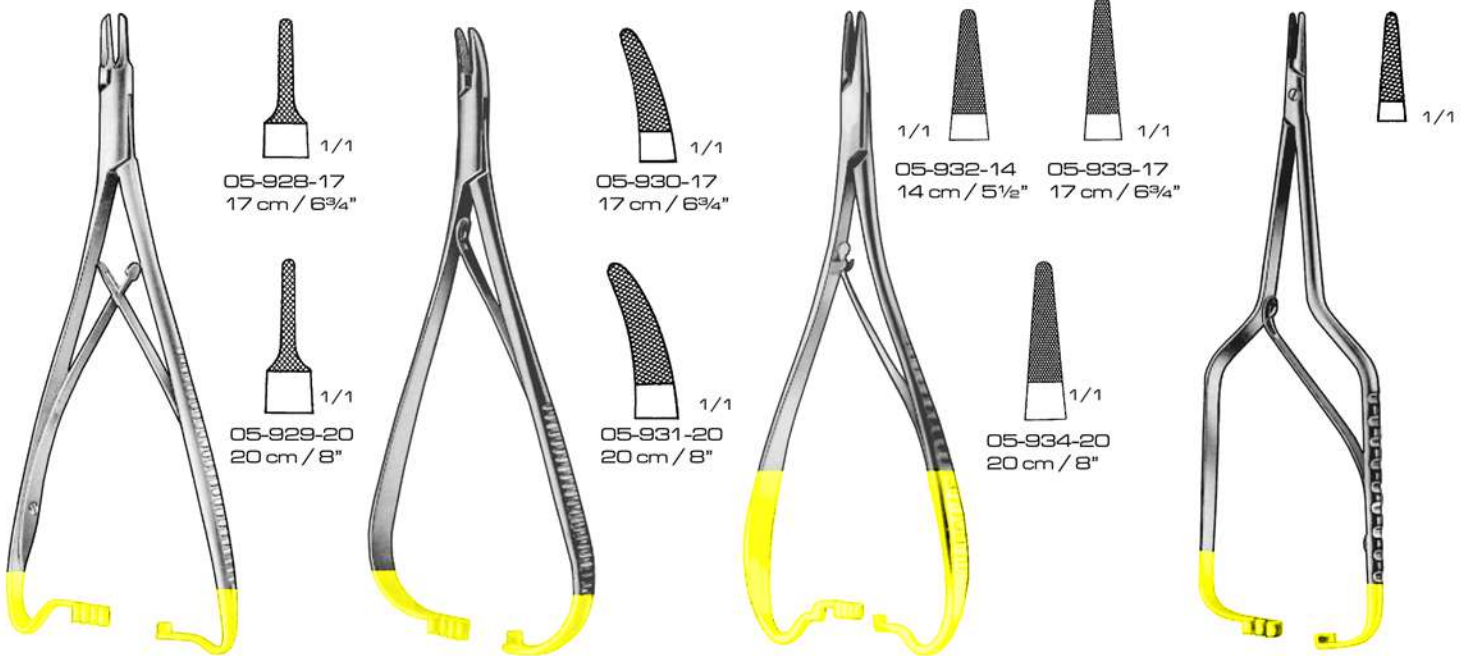

Mathieu-Slim

Metzenbum-Mathieu

Mathieu

Arruga
05-935-16
16 cm / 6¼"

1/1 1/1
05-936-20 20 cm / 8" 05-937-23 23 cm / 9"

1/1
05-938-20 20 cm / 7"

1/1 1/1
05-939-16 16 cm / 6 1/4" 05-940-18 18 cm / 7"

1/1 1/1
05-941-20 20 cm / 8"

1/1 1/1
05-942-18 18 cm / 7" 05-943-20 20 cm / 8"

1/1
05-944-23 23 cm / 9"

Zwifel

Langenbeck-Ryder

Langenbeck

Langenbeck

1/1 1/1
05-945-14 05-946-14

1/1 1/1

1/1 1/1
05-949-14 14 cm / 5 1/2" 05-950-18 18 cm / 7" 05-951-20 20 cm / 8"

1/1 1/1 1/1
05-952-14 14 cm / 5 1/2" 05-953-18 18 cm / 7" 05-954-20 20 cm / 8"

Kalt

Castroviejo

Toennis

Castroviejo

Jacobson

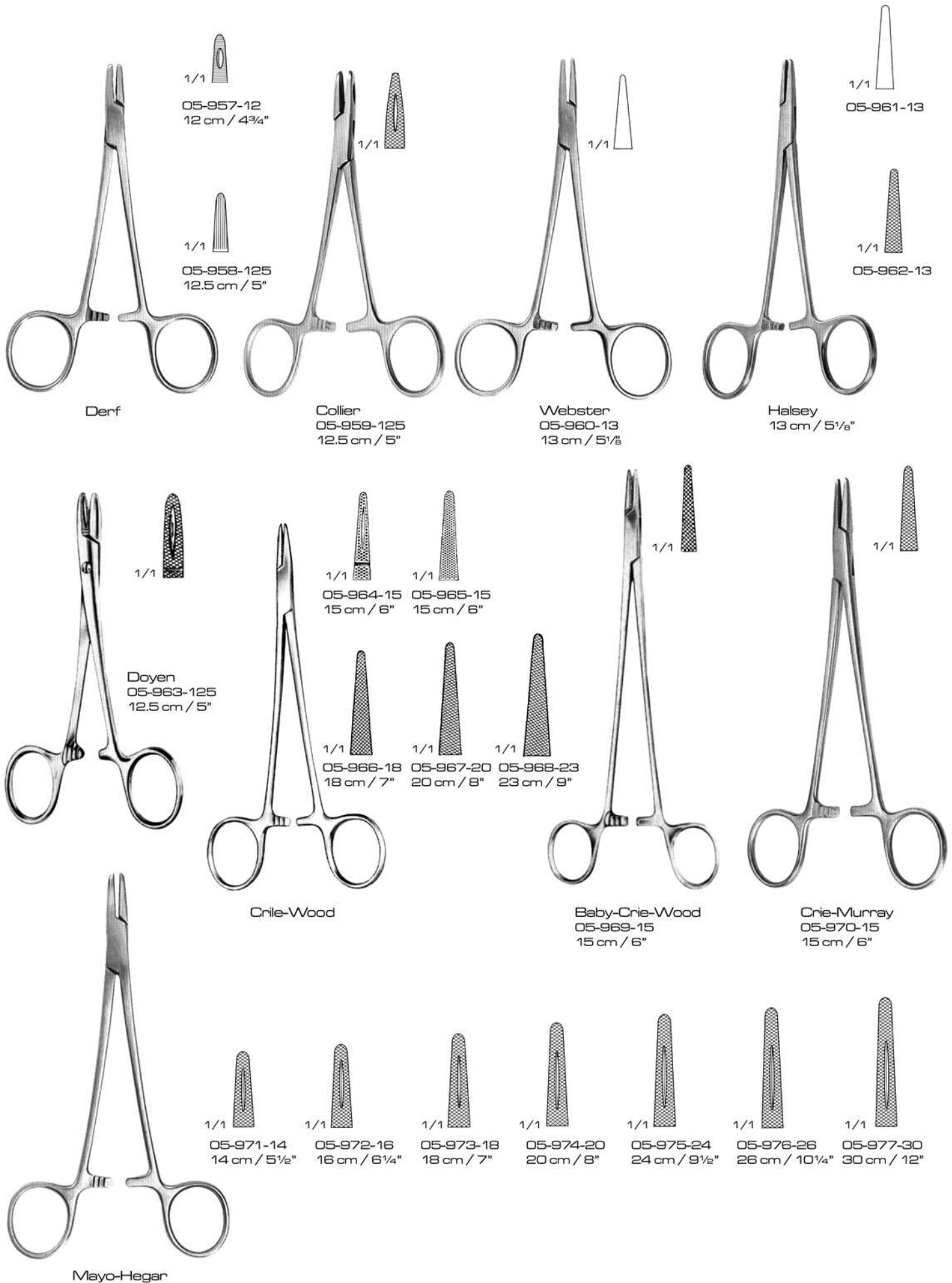

1/1
05-957-12
12 cm / 4¾"

1/1
05-958-125
12.5 cm / 5"

1/1

Collier
05-959-125
12.5 cm / 5"

1/1

Webster
05-960-13
13 cm / 5⅛"

1/1
05-961-13

1/1
05-962-13

Derf

Halsey
13 cm / 5⅛"

1/1

Doyen
05-963-125
12.5 cm / 5"

1/1

05-964-15 15 cm / 6"

1/1

05-965-15 15 cm / 6"

1/1

05-966-18 18 cm / 7"

1/1

05-967-20 20 cm / 8"

1/1

05-968-23 23 cm / 9"

1/1

Baby-Crile-Wood
05-969-15
15 cm / 6"

1/1

Crile-Murray
05-970-15
15 cm / 6"

Crile-Wood

1/1

05-971-14 14 cm / 5½"

1/1

05-972-16 16 cm / 6¼"

1/1

05-973-18 18 cm / 7"

1/1

05-974-20 20 cm / 8"

1/1

05-975-24 24 cm / 9½"

1/1

05-976-26 26 cm / 10¼"

1/1

05-977-30 30 cm / 12"

Mayo-Hegar

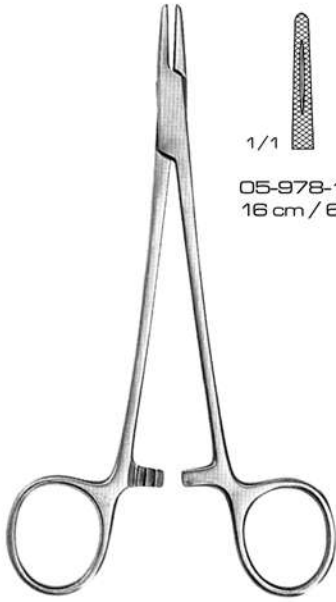

Mayo-Hegar-Delicate

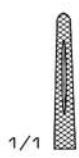

05-978-16
16 cm / 6¼"



05-979-18
18 cm / 7"

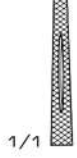

05-980-20
20 cm / 8"

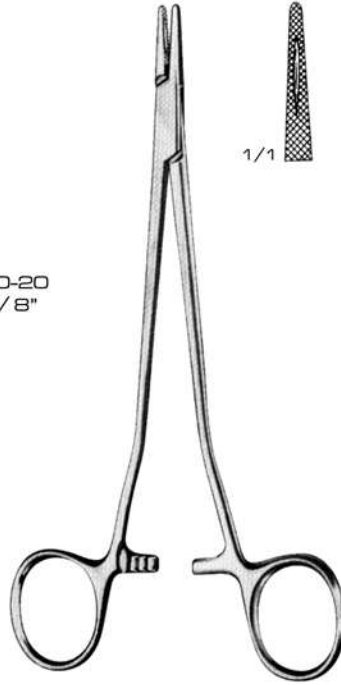

Sarat
05-981-18
18 cm / 7"

1/1



Wangensteen
05-982-27
27 cm / 10½"

1/1



Bozemann



05-983-20
20 cm / 8"



05-984-24
24 cm / 9½"



05-985-26
26 cm / 10¼"

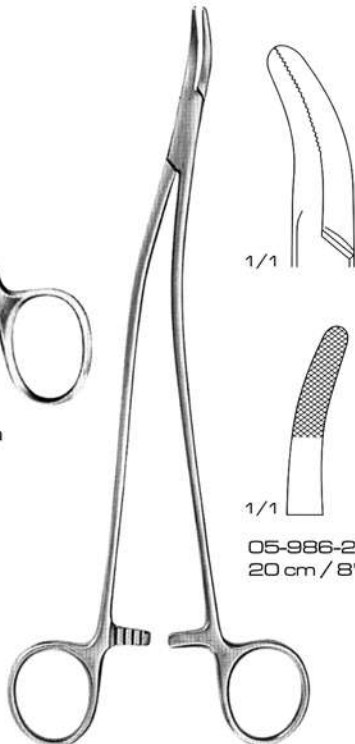

Strate



1/1

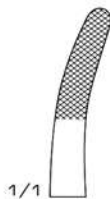

1/1

05-986-20
20 cm / 8"

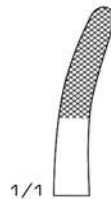

1/1

05-987-23
23 cm / 9"

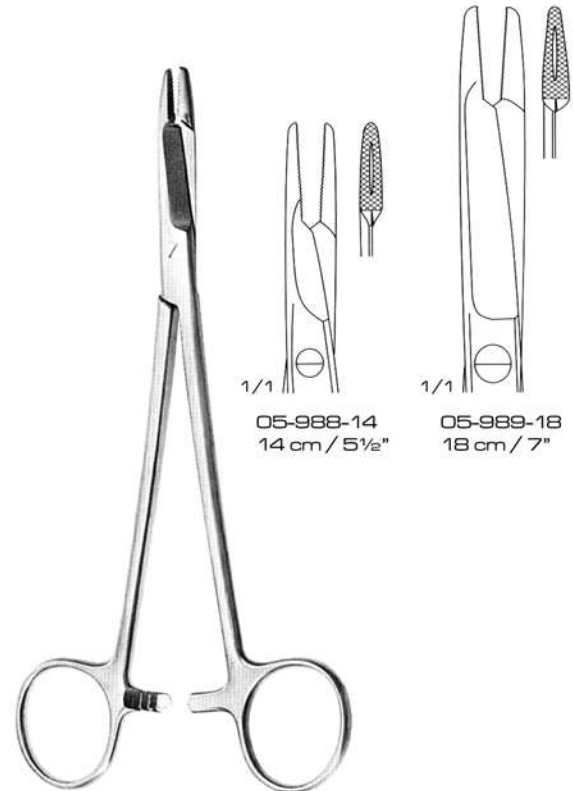

Olsen-Hegar



1/1

05-988-14
14 cm / 5½"

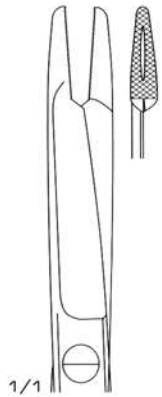

1/1

05-989-18
18 cm / 7"



1/1 1/1
 05-990-20 05-991-25
 20 cm / 8" 25 cm / 10"

Lichtenberg



1/1

Mathieu-Sverige
 05-992-17 17 cm / 6¾"



Mathieu-Kersten
 05-993-17 17 cm / 6¾"
 05-994-20 20 cm / 8"



1/1 1/1
 05-995-14 05-996-17
 14 cm / 5½" 17 cm / 6¾"

Matheiu

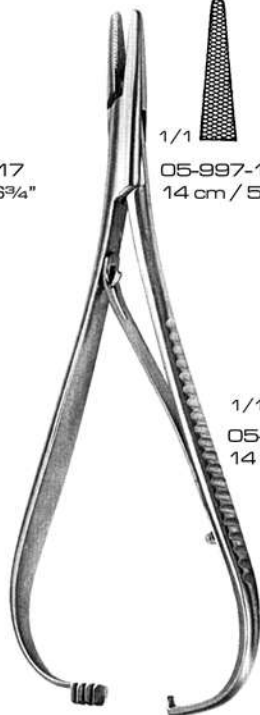

1/1 1/1 1/1 1/1
 05-997-14 05-998-17 05-999-20 05-1000-24
 14 cm / 5½" 17 cm / 6¾" 20 cm / 8" 24 cm / 9½"

1/1 1/1 1/1
 05-1001-14 05-1002-17 05-1003-20
 14 cm / 5½" 17 cm / 6¾" 20 cm / 8"

Matheiu



1/1

Matheiu-Kocher
 05-1004-20 20 cm / 8"

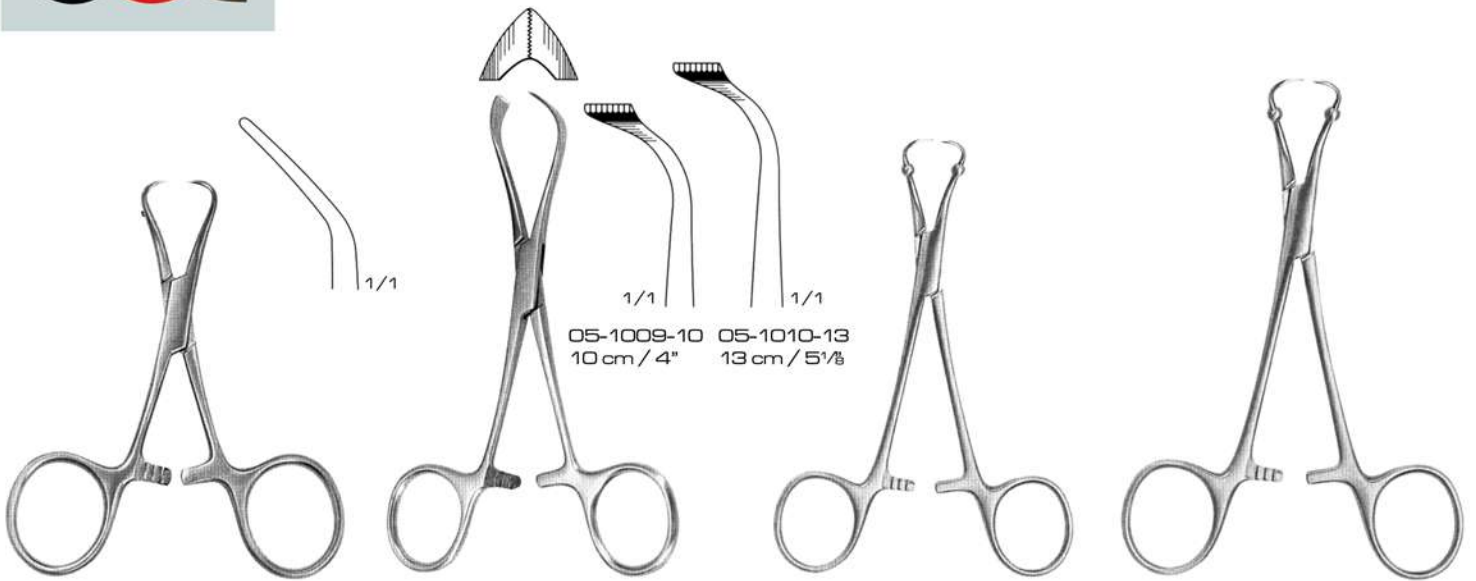

Backhaus
 05-1005-9 9 cm / 3½"
 05-1006-11 11 cm / 4¾"
 05-1007-13 13 cm / 5 ⅞"
 05-1008-15 15 cm / 6"

Lorna

05-1009-10 10 cm / 4"
 05-1010-13 13 cm / 5 ⅞"

Roeder
 05-1011-13
 13 cm / 5 ⅞"

Roeder
 05-1012-15
 15 cm / 6"

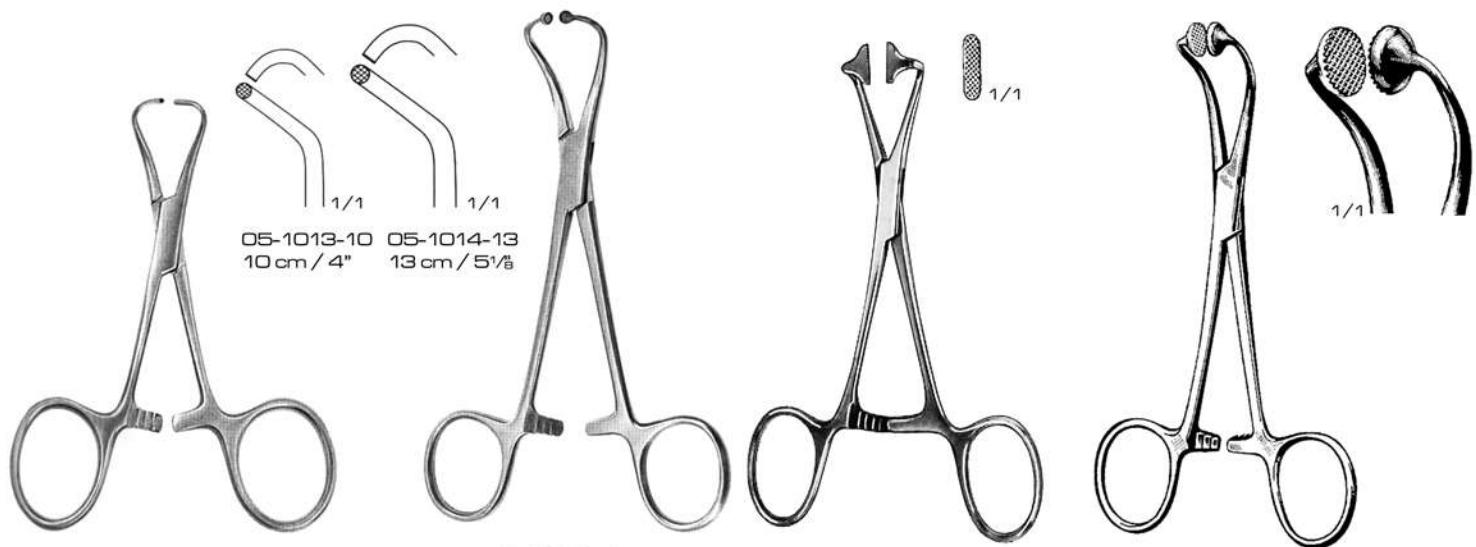

Tohoku

05-1013-10 10 cm / 4"
 05-1014-13 13 cm / 5 ⅞"

Ball & Socket
 05-1015-13
 13 cm / 5 ⅞"

05-1016-13
 13 cm / 5 ⅞"

Hoff
 05-1017-10 10 cm / 4"
 05-1018-145 14.5 cm / 5 ⅞"



Peers
 05-1019-145
 14.5 cm / 5¾"

Lane
 05-1020-13 13 cm / 5 ⅞"
 05-1021-15 15 cm / 6"
 05-1022-20 20 cm / 8"

Bernhard
 05-1024-11 11 cm / 4¾"
 05-1025-13 13 cm / 5 ⅞"
 (Delicate)

Bernhard
 05-1023-165
 16.5 cm / 6½"



Scheadel
05-1026-9
9 cm / 3 1/2"



Jones
05-1027-5
5 cm / 2"



Eng. Modell
05-1029-9
9 cm / 3 1/2"

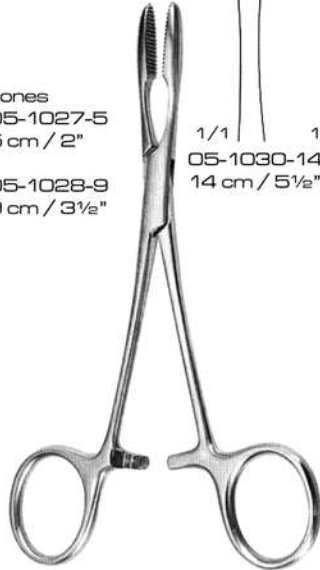

05-1028-9
9 cm / 3 1/2"



1/1
05-1030-14
14 cm / 5 1/2"



1/1
05-1031-16
16 cm / 6 1/4"

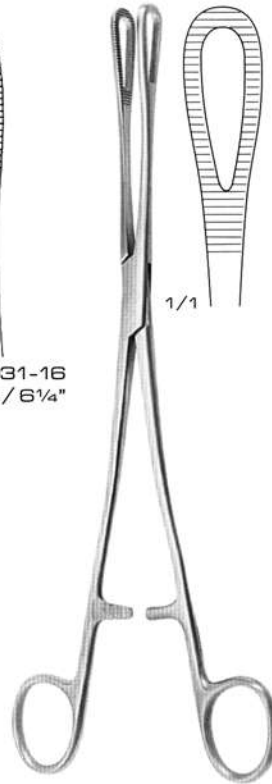

Ramsey
05-1032-25
25 cm / 10"



1/1
05-1033-18
18 cm / 7"

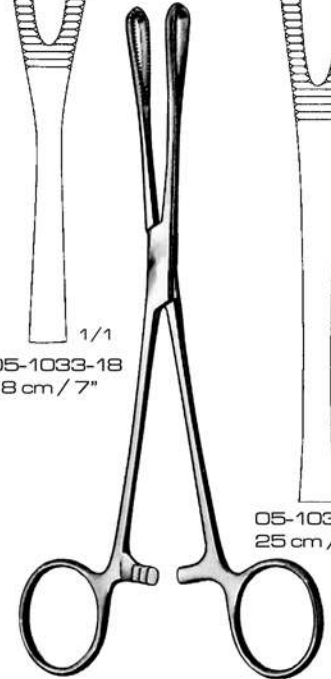

Ramsey



1/1
05-1034-25
25 cm / 10"

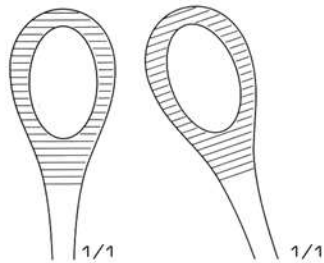

1/1
16 cm / 6 1/4" 05-1035-16 05-1040-16
18 cm / 7" 05-1036-18 05-1041-18
20 cm / 8" 05-1037-20 05-1042-20
24 cm / 9 1/2" 05-1038-24 05-1043-24
25 cm / 10" 05-1039-25 05-1044-25

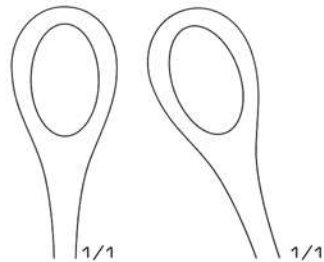

1/1
16 cm / 6 1/4" 05-1045-16 05-1050-16
18 cm / 7" 05-1046-18 05-1051-18
20 cm / 8" 05-1047-20 05-1052-20
24 cm / 9 1/2" 05-1048-24 05-1053-24
25 cm / 10" 05-1049-25 05-1054-25



Foerster

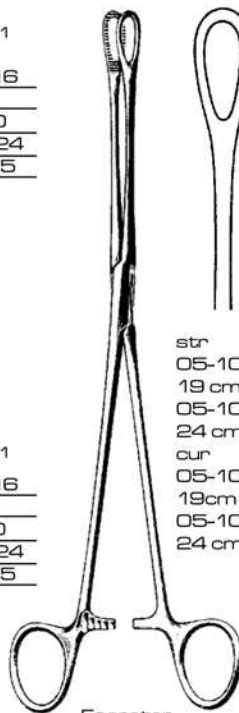

Foerster

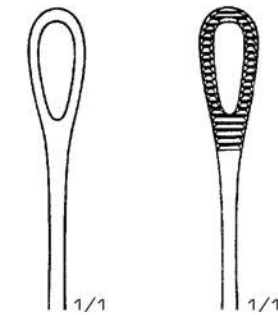

1/1
str
05-1055-19 05-1059-19
19 cm / 7 1/2" 19 cm / 7 1/2"
05-1056-24 05-1060-24
24 cm / 8 1/2" 24 cm / 8 1/2"
cur
05-1057-19 05-1061-19
19 cm / 7 1/2" 19 cm / 7 1/2"
05-1058-24 05-1062-24
24 cm / 8 1/2" 24 cm / 8 1/2"

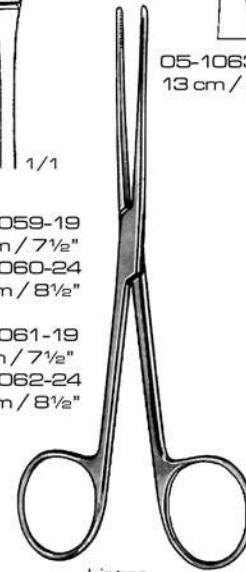

Lister

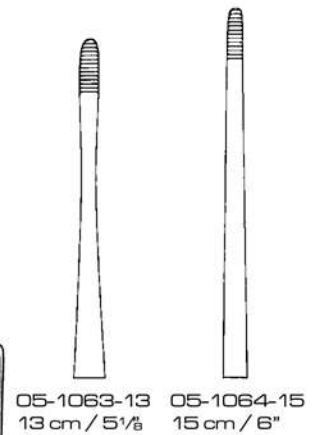

05-1063-13 05-1064-15
13 cm / 5 1/8" 15 cm / 6"



05-1065-18
18 cm / 7"



Foerster

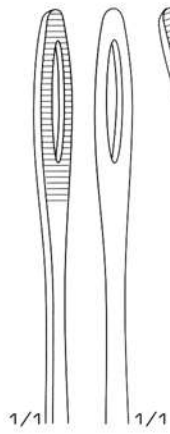

05-1066-25
25 cm / 10"

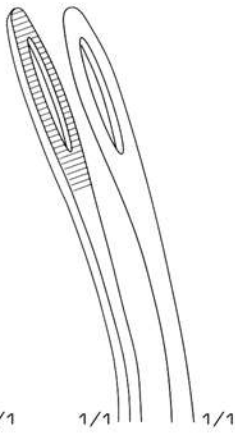

05-1067-25
25 cm / 10"

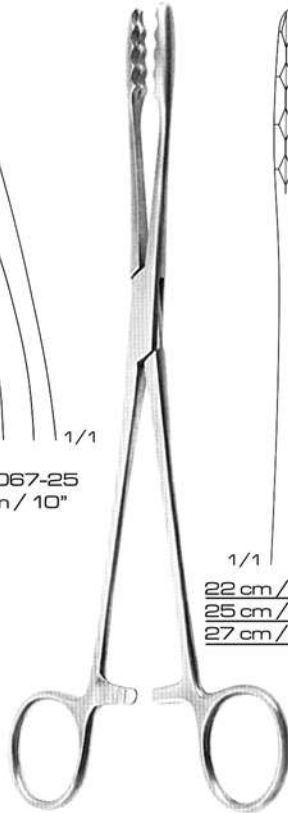

Ulrich

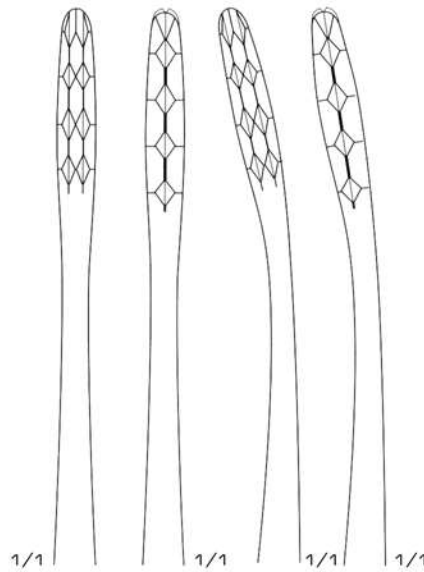

22 cm / 8³/₄" 05-1068-22 05-1071-22
25 cm / 10" 05-1069-25 05-1072-25
27 cm / 10³/₄" 05-1070-27 05-1073-27

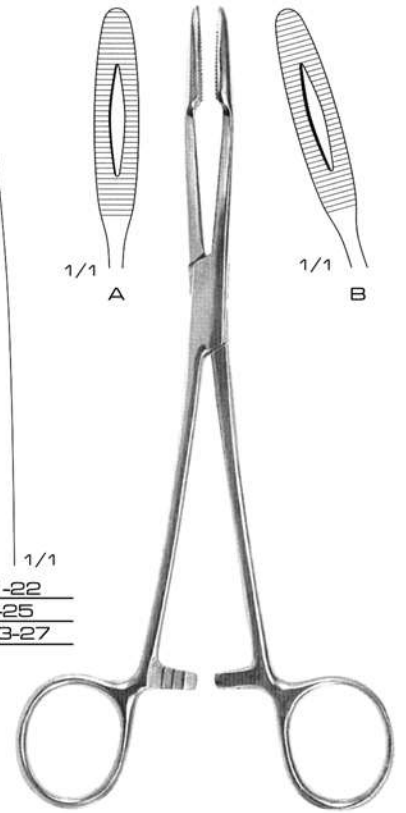

Gross-Maier A B
20 cm / 8" 05-1074-20 05-1078-20
22 cm / 8³/₄" 05-1075-22 05-1079-22
25 cm / 10" 05-1076-25 05-1080-25
27 cm / 10³/₄" 05-1077-27 05-1081-27

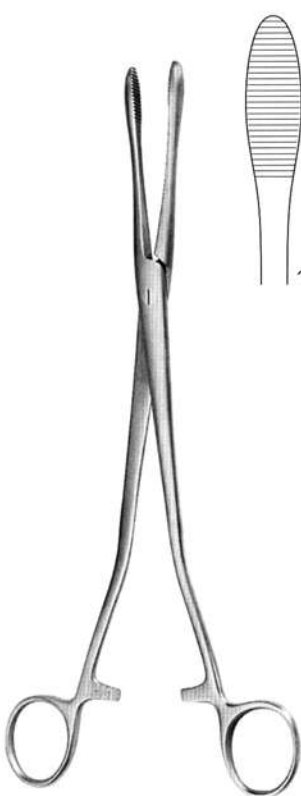

Collin
05-1082-25
25 cm / 10"

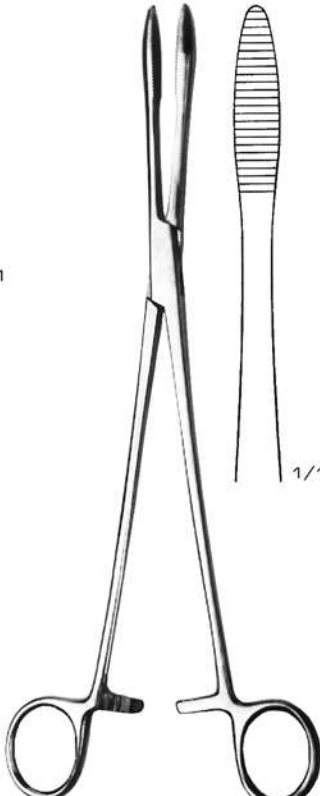

Collin
05-1083-25
25 cm / 10"

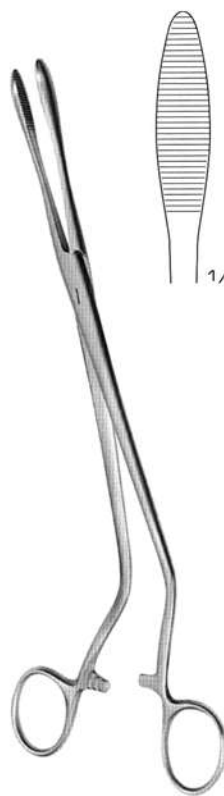

Cheron
05-1084-25
25 cm / 10"

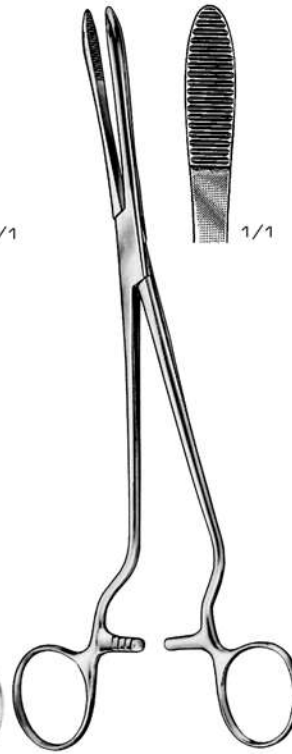

Cheron
05-1085-25
25 cm / 10"



Pelkman
25 cm / 10"

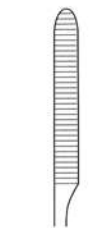

05-1086-25

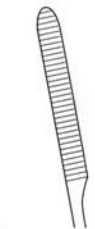

05-1087-25

HAEMOSTATIC AND TISSUE GRASPING FORCEPS

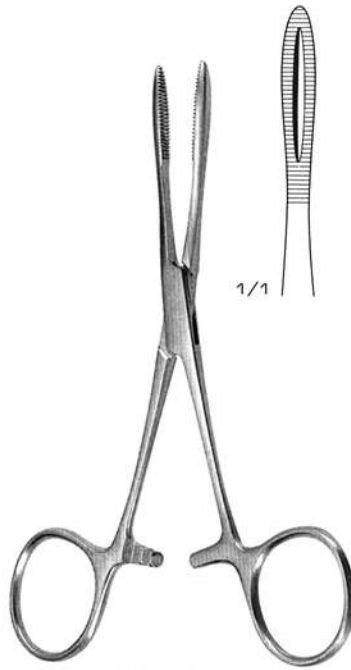
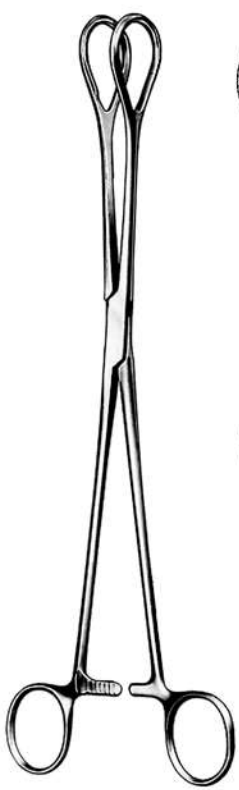

Kroenlein
05-1090-13
13 cm / 5 1/8"

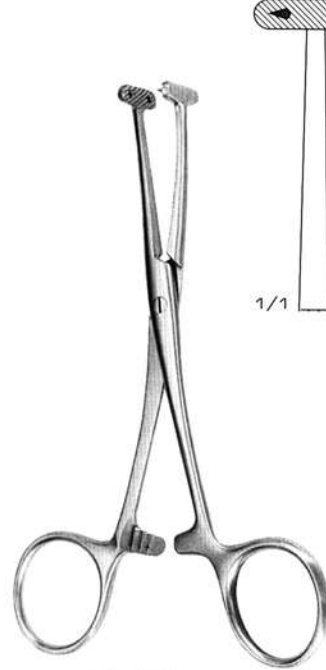

Martel
05-1091-14
14 cm / 5 1/2"

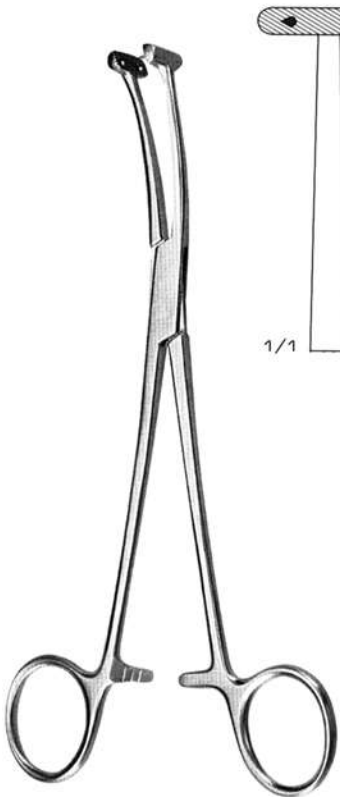
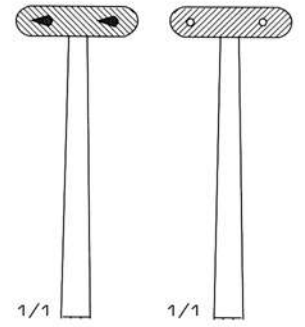

Willet-Martel
05-1092-19
19 cm / 7 1/2"

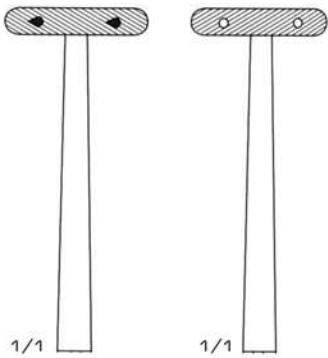

Collin
05-1093-16
16 cm / 6 1/4"

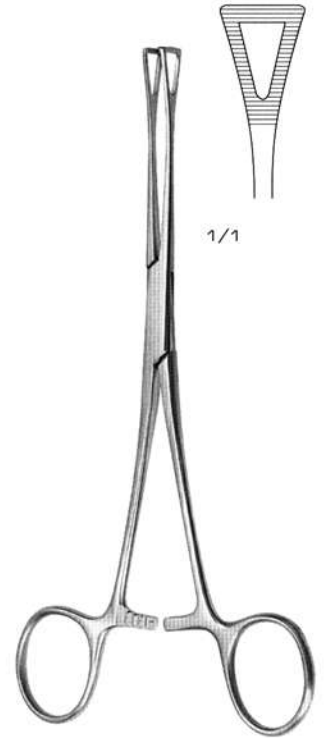
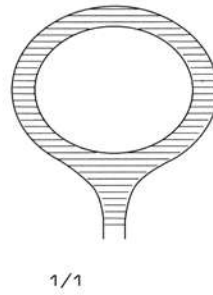

Pennington
05-1094-155
15.5 cm / 6"



Chaput
05-1096-13
13 cm / 5 1/8"



Tuffier
05-1097-13
13 cm / 5 1/8"

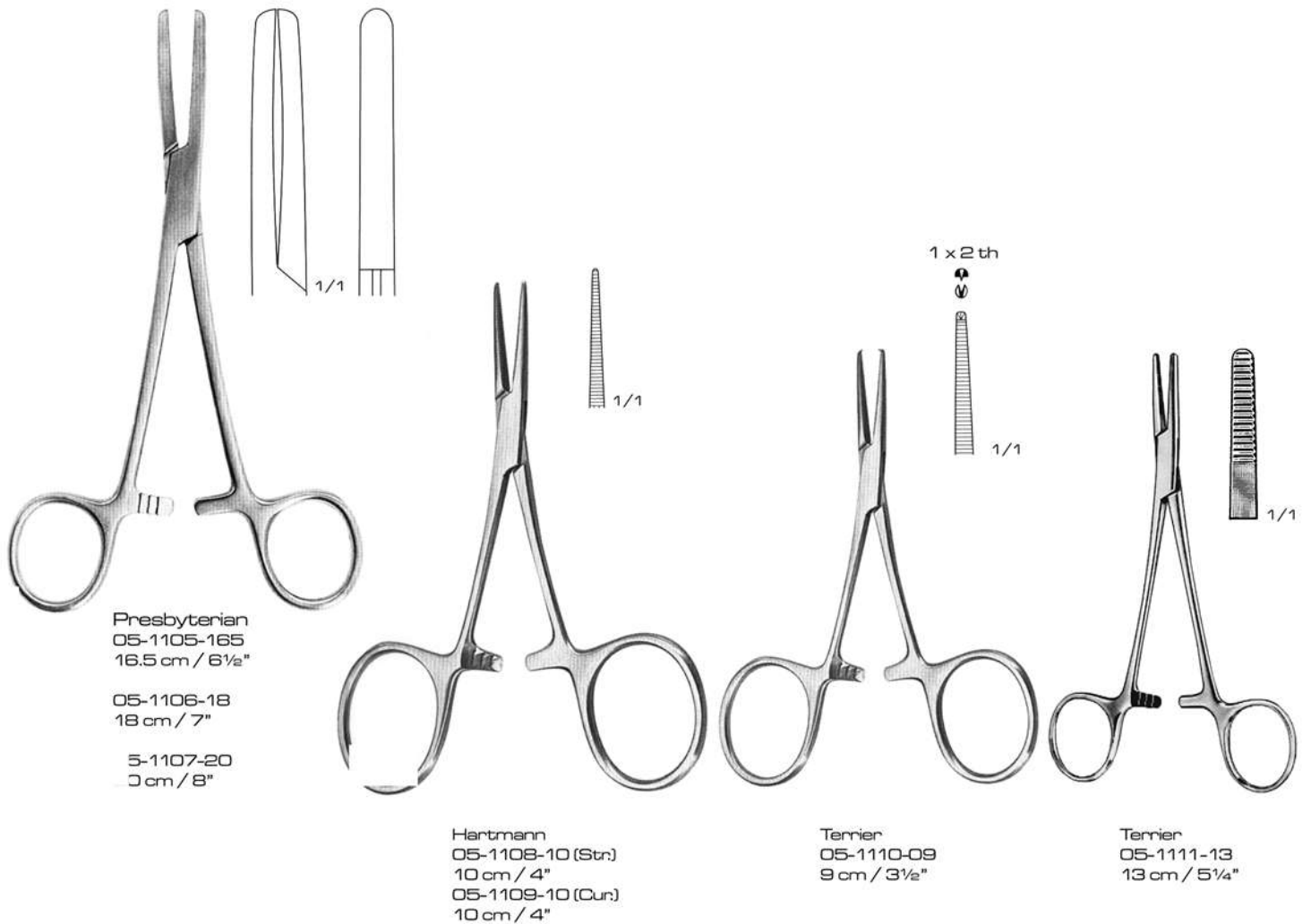
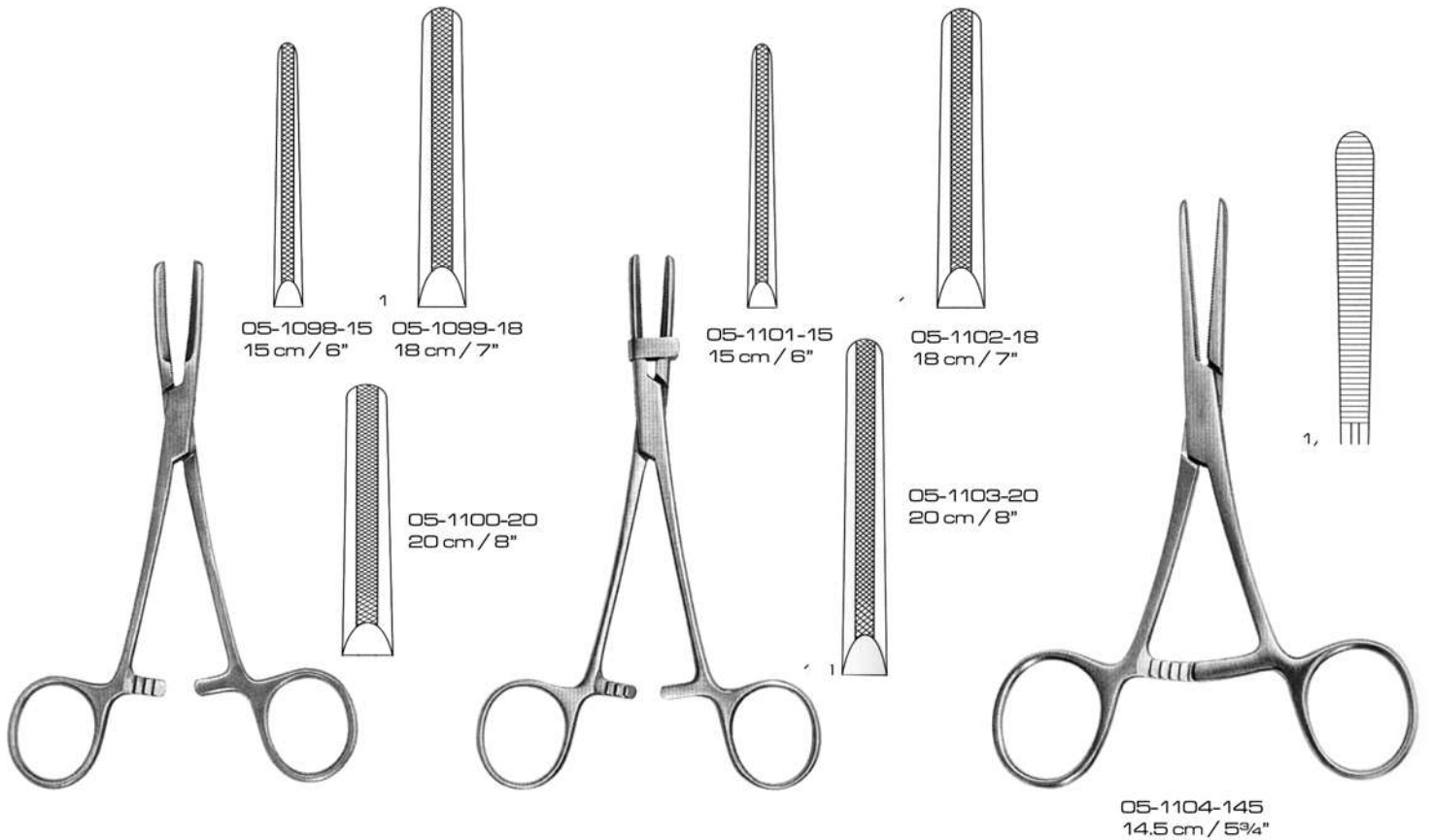



Halstead-Mosquito

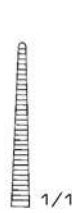

1/1

05-1112-125
12.5 cm / 5"

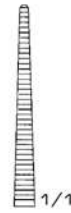

1/1

05-1113-14
14 cm / 5½"

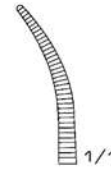

1/1

05-1114-125
12.5 cm / 5"

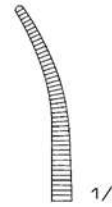

1/1

05-1115-14
14 cm / 5½"

1 x 2 th
↻

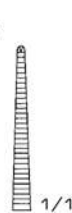

1/1

05-1116-125
12.5 cm / 5"

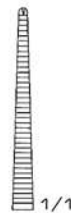

1/1

05-1117-14
14 cm / 5½"

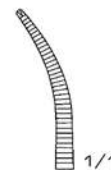

1/1

05-1118-125
12.5 cm / 5"



1/1

05-1119-14
14 cm / 5½"

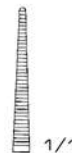

1/1

05-1120-10
10 cm / 4"



1/1

05-1121-12
12 cm / 4¾"



1/1

05-1122-10
10 cm / 4"

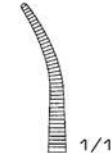

1/1

05-1123-12
12 cm / 4¾"

1 x 2 th
↻

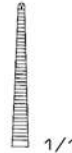

1/1

05-1124-10
10 cm / 4"

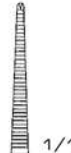

1/1

05-1125-12
12 cm / 4¾"



1/1

05-1126-10
10 cm / 4"

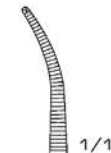

1/1

05-1127-12
12 cm / 4¾"



Halstead

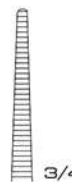

3/4

05-1128-16
16 cm / 7"

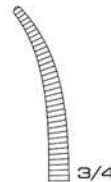

3/4

05-1129-16
16 cm / 7"

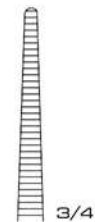

3/4

05-1130-18
18 cm / 7"

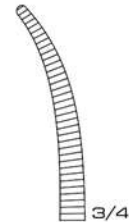

3/4

05-1131-18
18 cm / 7"

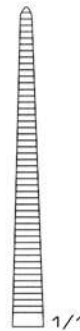

1/1

05-1132-21
21 cm / 8¼"

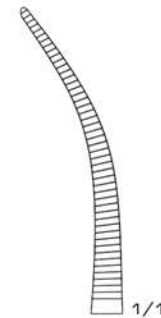

1/1

05-1133-21
21 cm / 8¼"

1 x 2 th
↻



1/1

05-1134-16
16 cm / 7"

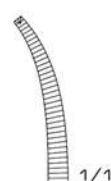

1/1

05-1135-16
16 cm / 7"

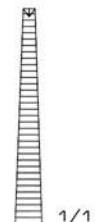

1/1

05-1136-18
18 cm / 7"

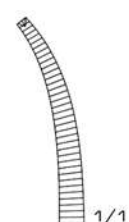

1/1

05-1137-18
18 cm / 7"

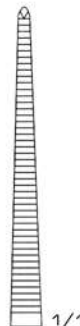

1/1

05-1138-21
21 cm / 8¼"

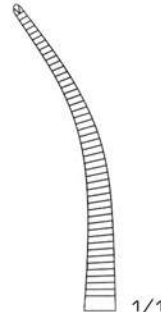

1/1

05-1139-21
21 cm / 8¼"

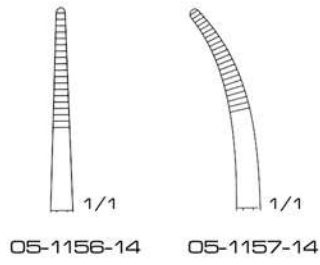

Providence-Hospital
14 cm / 5½"

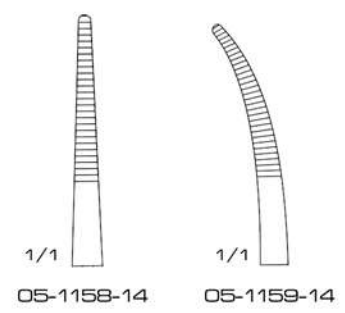
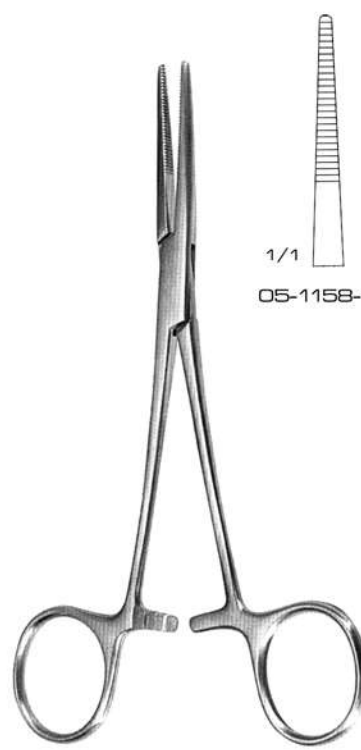

Kelly
14 cm / 5½"

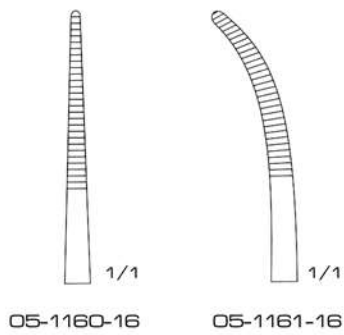
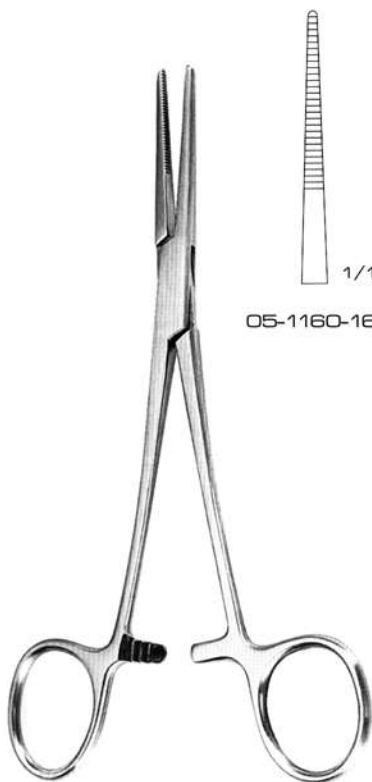

Kelly-Rankin
16 cm / 6¼"

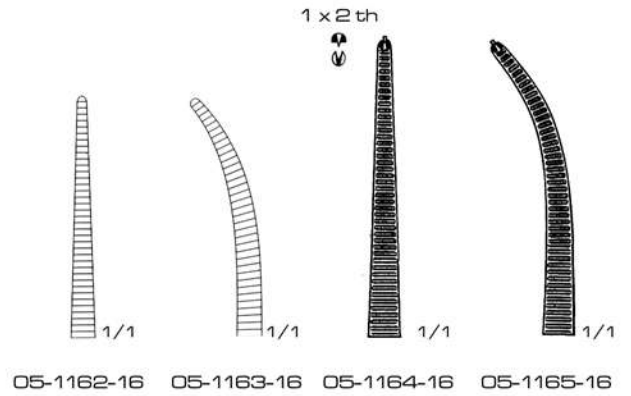
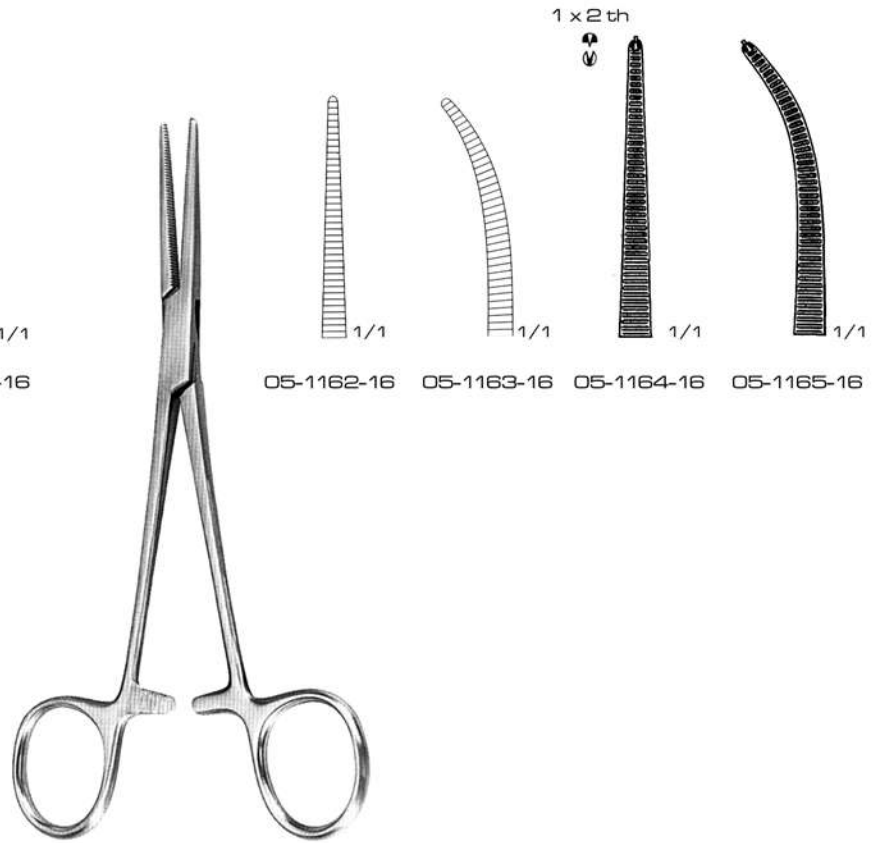

Crile-Rankin
16 cm / 6¼"

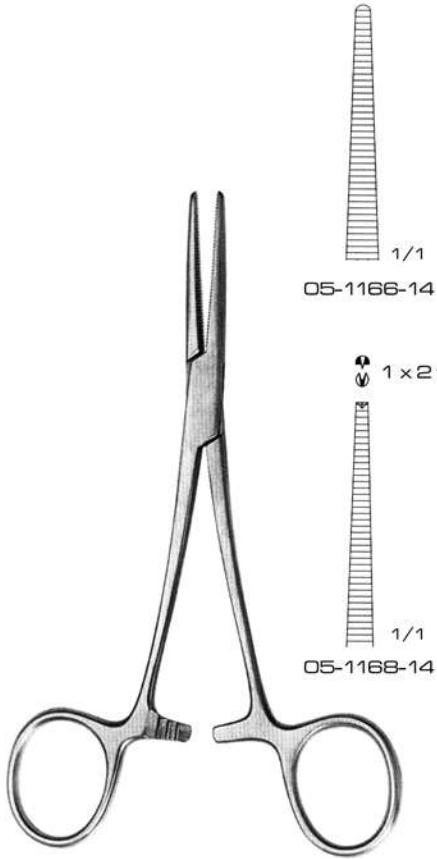

Crile
14 cm / 5½"

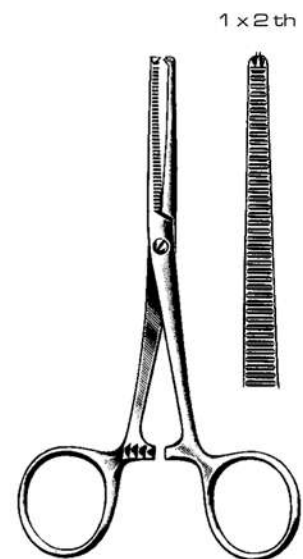
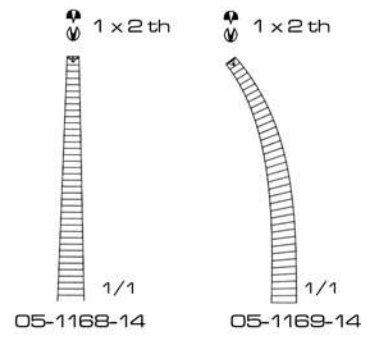
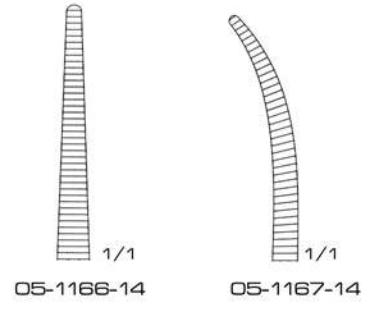

Kocher
05-1170-14
14 cm / 5½"

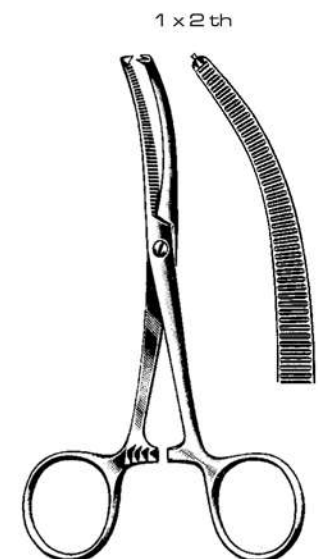

Kocher
05-1171-14
14 cm / 5½"



Pean Delicate

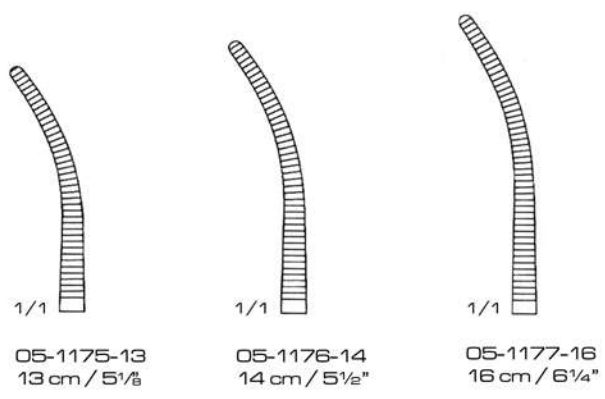
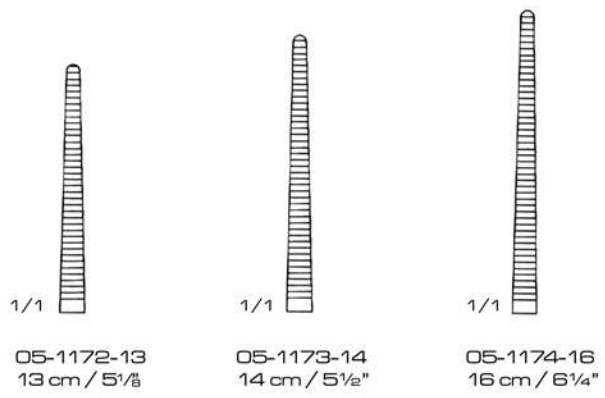

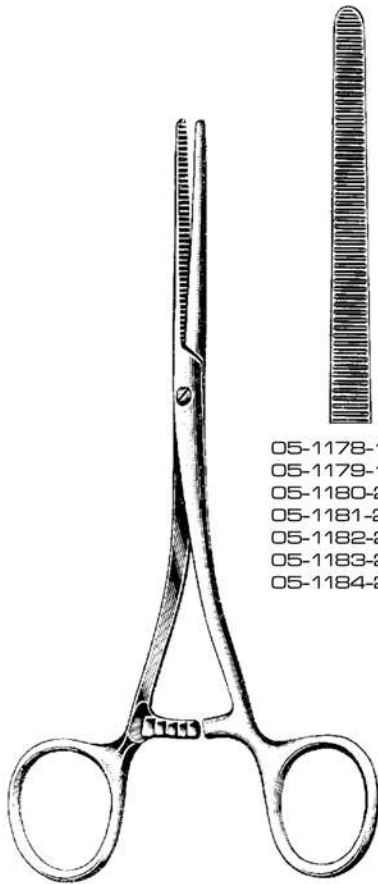

Pean

05-1178-16 16 cm / 6¼" 05-1185-16
 05-1179-18 18 cm / 7" 05-1186-18
 05-1180-20 20 cm / 8" 05-1187-20
 05-1181-22 22 cm / 8¾" 05-1188-22
 05-1182-24 24 cm / 9½" 05-1189-24
 05-1183-26 26 cm / 10¼" 05-1190-26
 05-1184-28 28 cm / 11" 05-1191-28

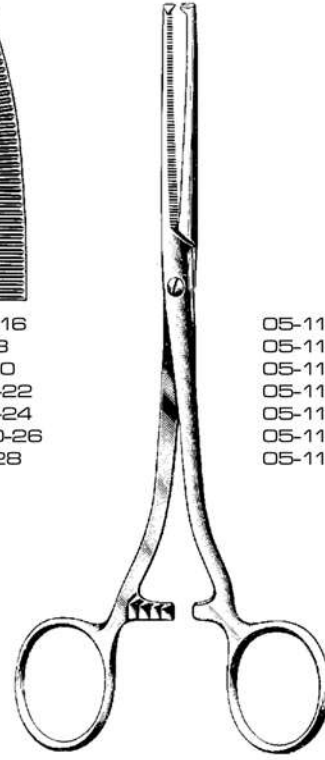

Kocher

05-1192-16 16 cm / 6¼" 05-1199-16
 05-1193-18 18 cm / 7" 05-1200-18
 05-1194-20 20 cm / 8" 05-1201-20
 05-1195-22 22 cm / 8¾" 05-1202-22
 05-1196-24 24 cm / 9½" 05-1203-24
 05-1197-26 26 cm / 10¼" 05-1204-26
 05-1198-28 28 cm / 11" 05-1205-28

1 x 2 th



1 x 2 th

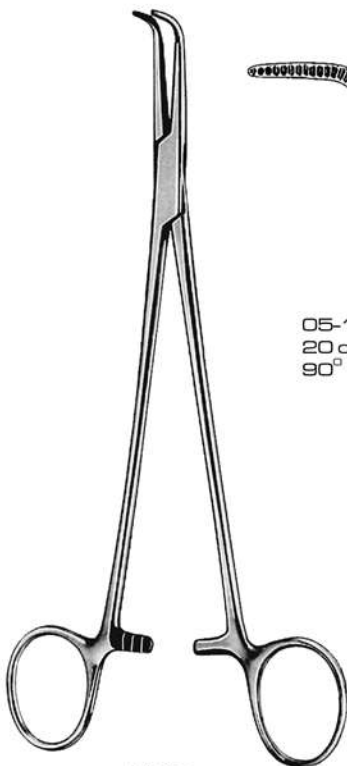

Heiss

05-1206-20 20 cm / 8" 90°
 05-1207-24 24 cm / 9½" 90°

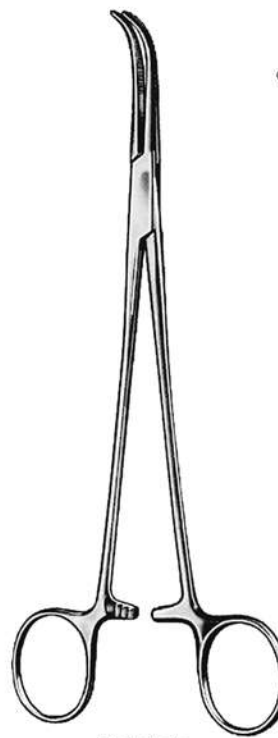

Schmidt
 19 cm / 7½"

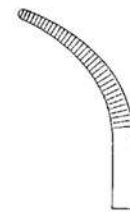

05-1208-19



05-1209-19

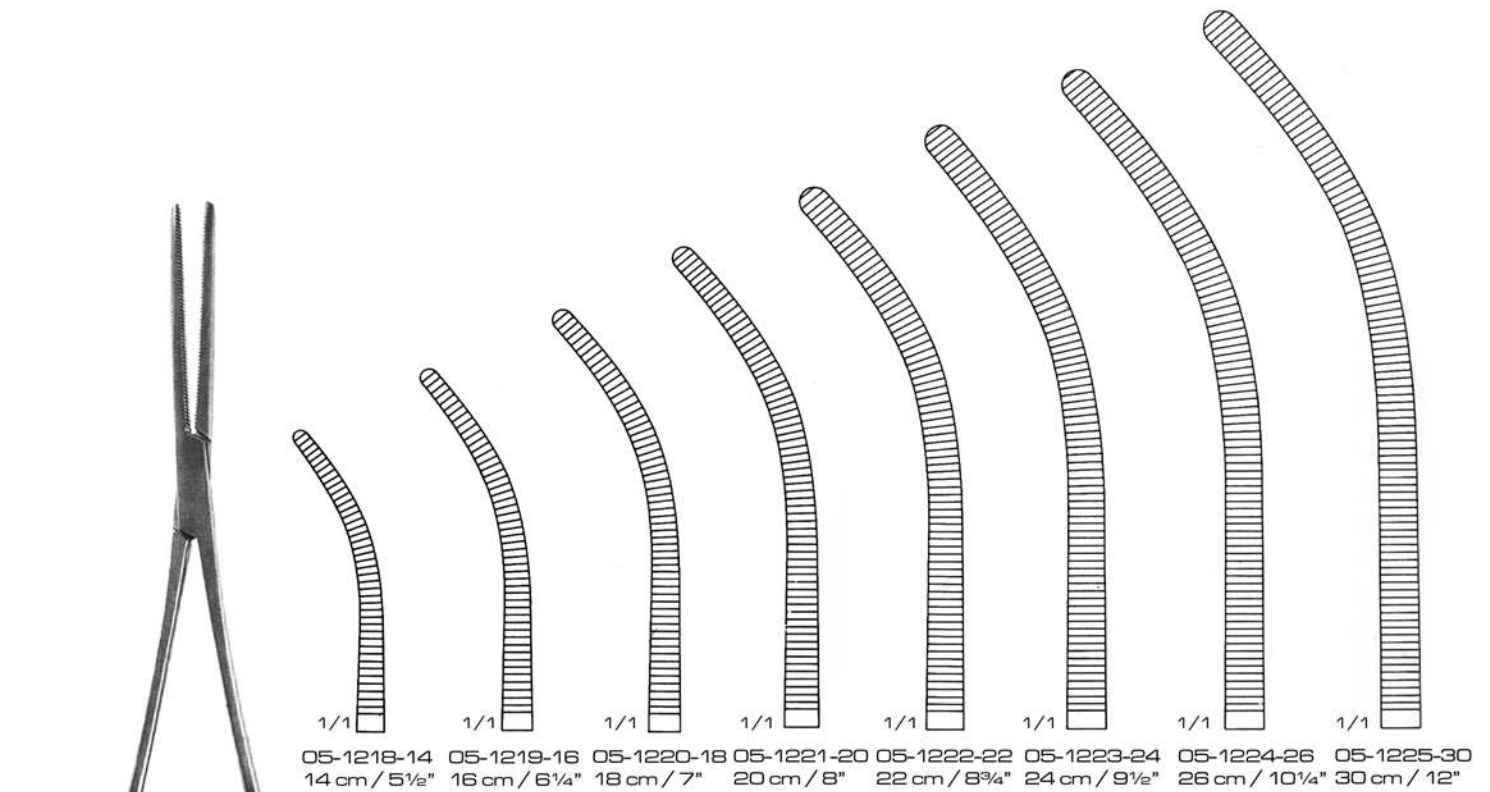
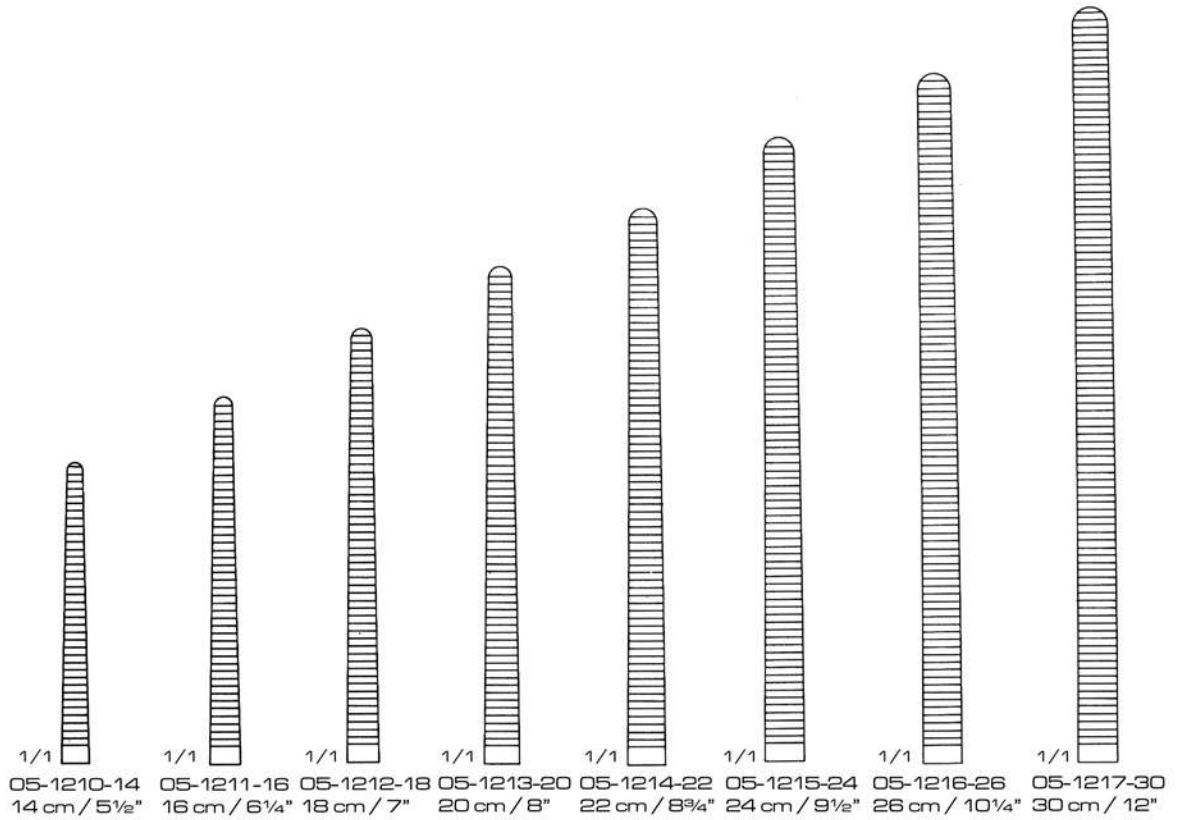

Rochester-Pean

1/1 1/1 1/1 1/1 1/1 1/1

05-1226-13 05-1227-14 05-1228-16 05-1229-18 05-1230-20
 13 cm / 5 1/8" 14 cm / 5 1/2" 16 cm / 6 1/4" 18 cm / 7" 20 cm / 8"

05-1231-13 05-1232-14 05-1233-16 05-1234-18 05-1235-20
 13 cm / 5 1/8" 14 cm / 5 1/2" 16 cm / 6 1/4" 18 cm / 7" 20 cm / 8"

1/1 1/1

05-1236-14 05-1237-16
 14 cm / 5 1/2" 16 cm / 6 1/4"

05-1238-14 05-1239-16
 14 cm / 5 1/2" 16 cm / 6 1/4"

Spencer-Wells Coller

1/1 1/1 1/1 1/1 1/1 1/1

05-1240-16 05-1241-20 05-1242-16 05-1243-20
 16 cm / 6 1/4" 20 cm / 8" 16 cm / 6 1/4" 20 cm / 8"

1/1 1/1

05-1244-14 05-1245-14

1 x 2 th

Rochester-Carmalt Dandy
 14 cm / 5 1/2"

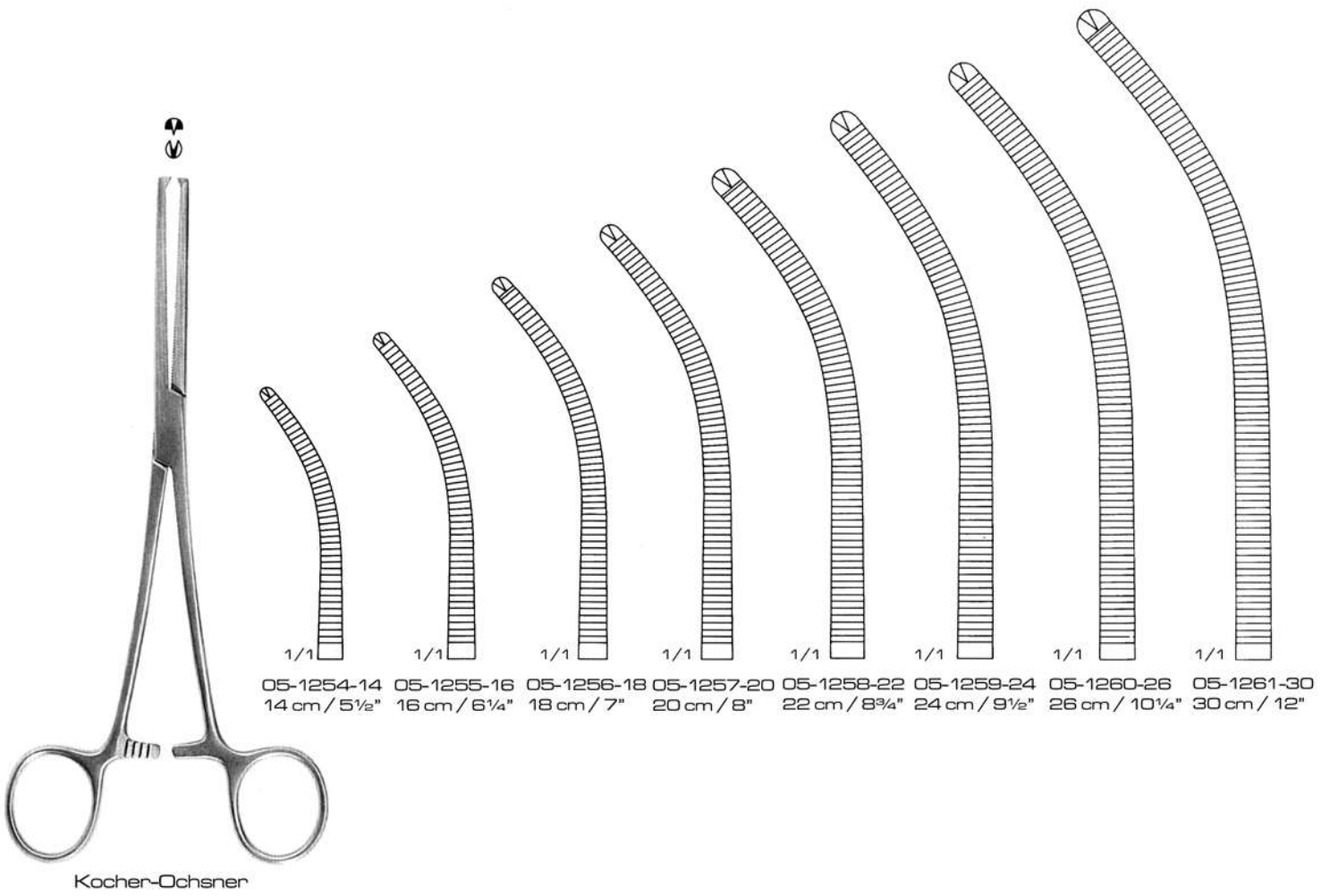
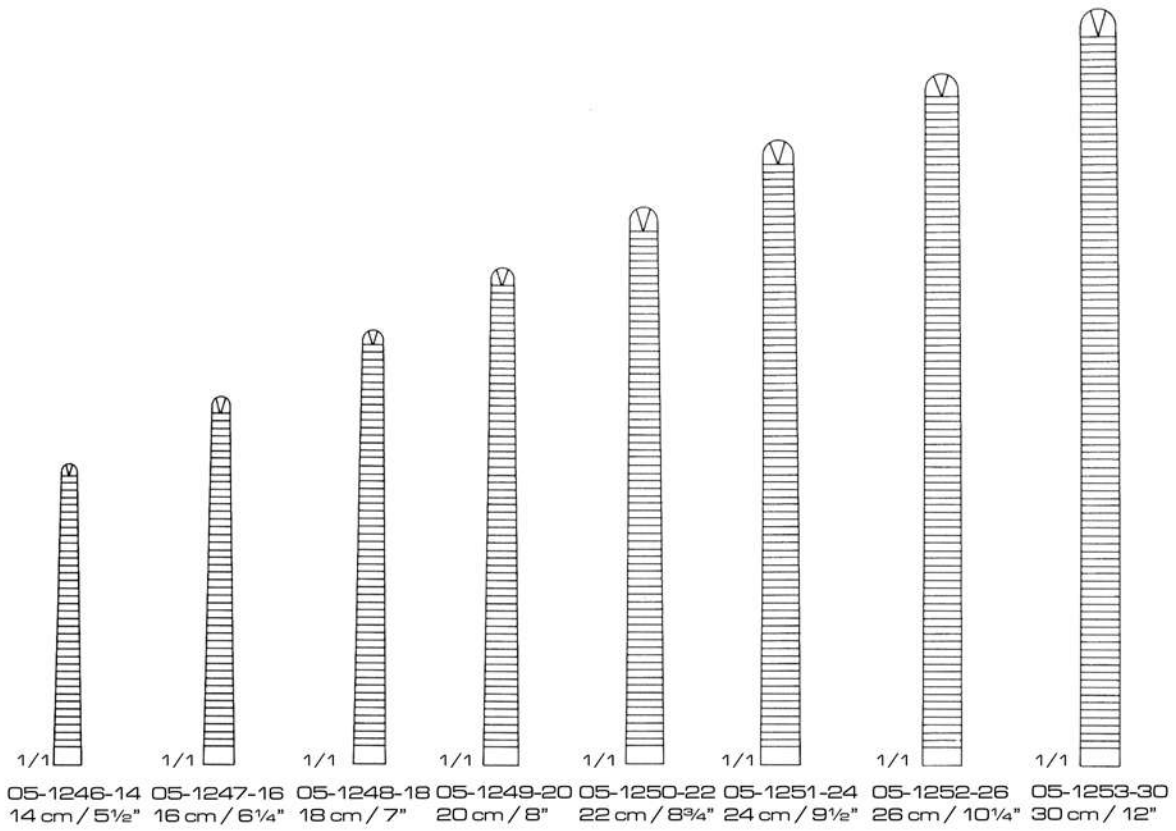

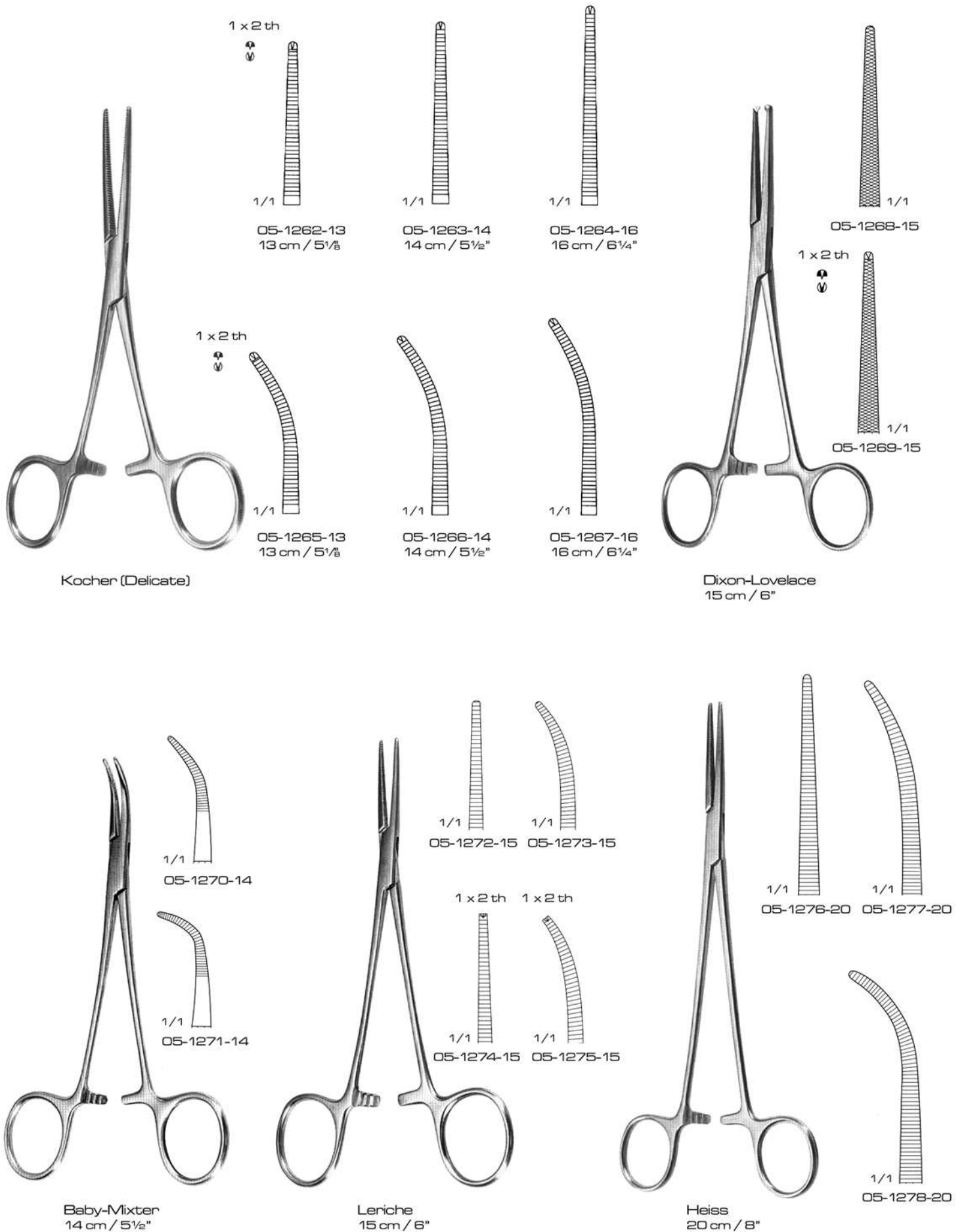



Bengolea

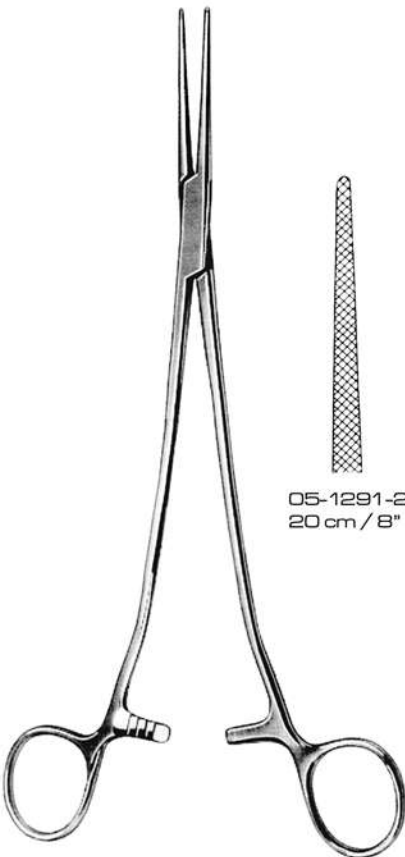
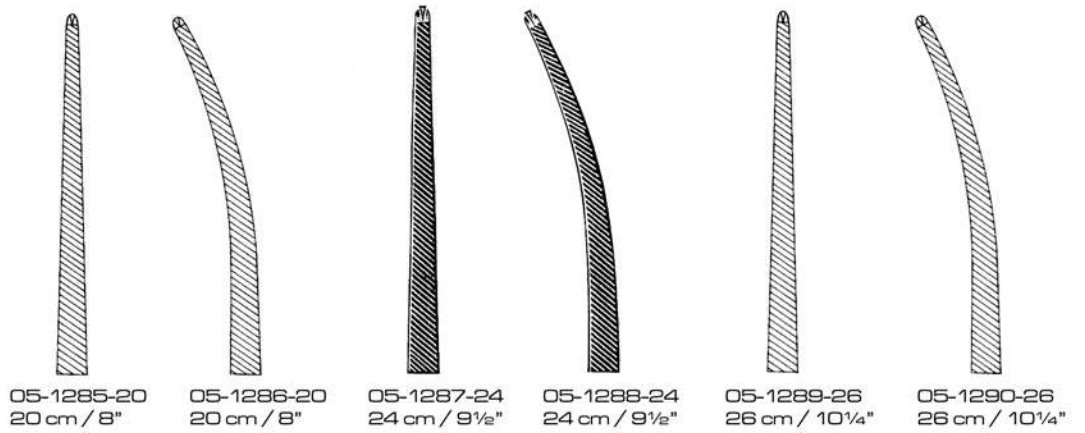
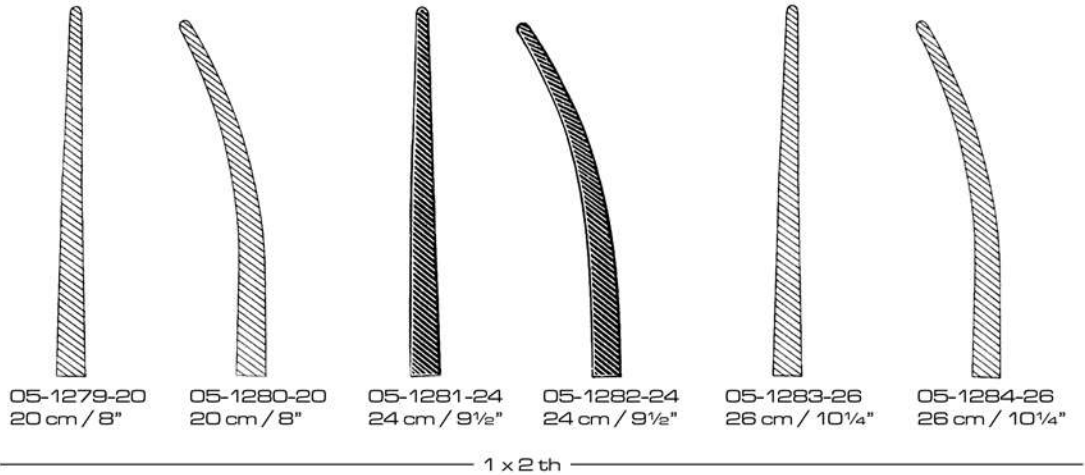

Bengolea

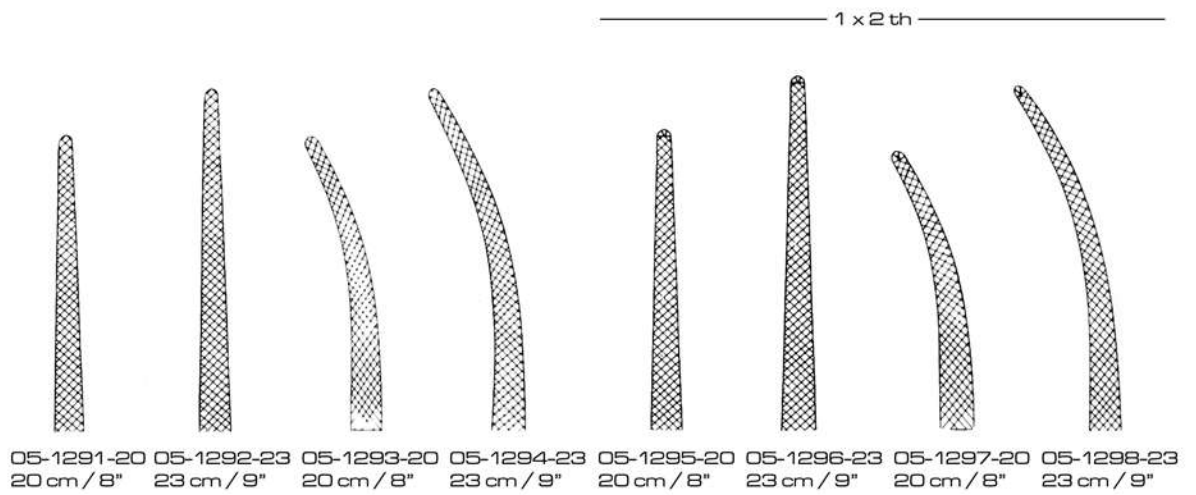



Baby-Adson

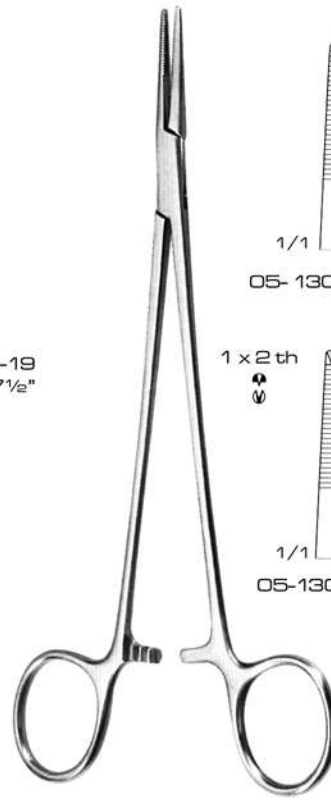
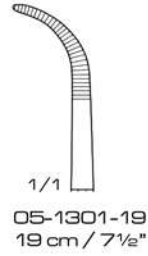
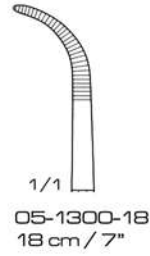
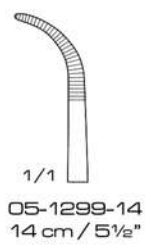

Adson
18.5 cm / 7¼"

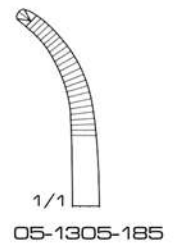
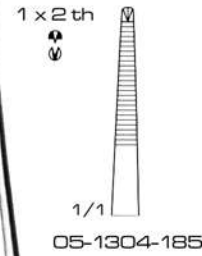
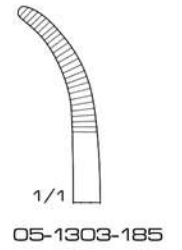
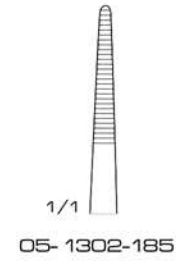

Overholt

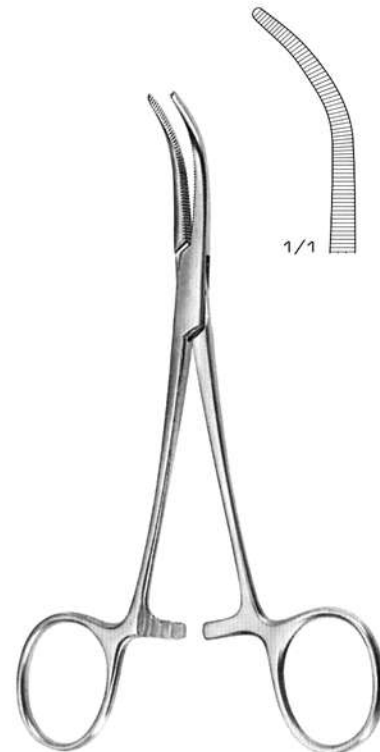
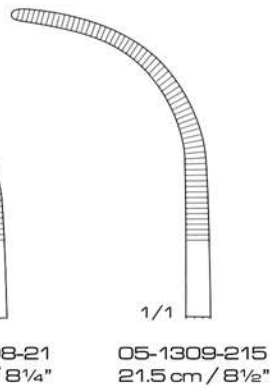
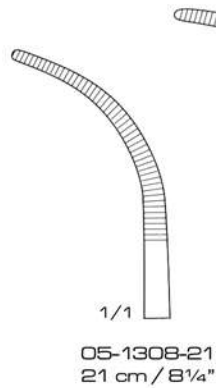
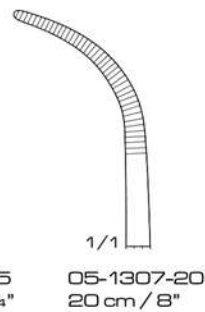
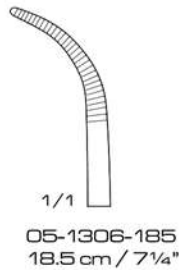

Baby-Overholt
05-1310-135
13.5 cm / 5¼"



1/1
05-1311-195 19.5 cm / 7¾"

1/1
05-1312-19 19 cm / 7½"

1/1
05-1313-21 21 cm / 8¼"

1/1
05-1314-22 22 cm / 8¾"

1/1
05-1315-215 21.5 cm / 8½"

1/1
05-1316-22 22 cm / 8¾"

1/1
05-1317-22 22 cm / 8¾"

1/1
05-1318-22 22 cm / 8"

1/1
05-1319-22 22 cm / 8"

Overholt-Geiddendoenfer

Roberts

1/1
05-1320-27 27 cm / 10¾"

1/1
05-1321-26 26 cm / 10½"

1/1
05-1322-27 27 cm / 10¾"

1/1
05-1323-275 27.5 cm / 10¾"

1/1
05-1324-27 27 cm / 10¾"

1/1
05-1325-28 28 cm / 11"

1/1
05-1326-28 28 cm / 11"

1/1
05-1327-24 24 cm / 9½"

Overholt-Geiddendoenfer

Crawfoord

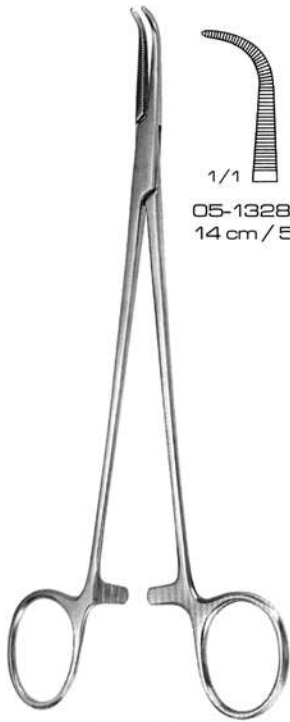

Gemini

1/1
05-1328-14
14 cm / 5½"

1/1
05-1329-16
16 cm / 6¼"

1/1
05-1330-18
18 cm / 7"

1/1
05-1331-20
20 cm / 8"

1/1
05-1335-20
20 cm / 8"

1/1
05-1336-24
24 cm / 9½"

1/1
05-1332-23
23 cm / 9"

1/1
05-1333-25
25 cm / 10"

1/1
05-1334-28
28 cm / 11"

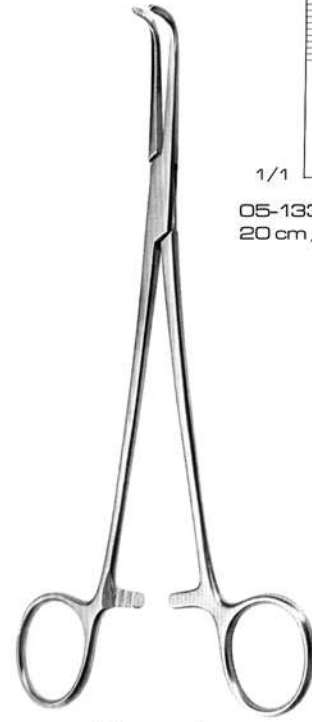

Kantrowitz

1/1
05-1337-28
28 cm / 11"

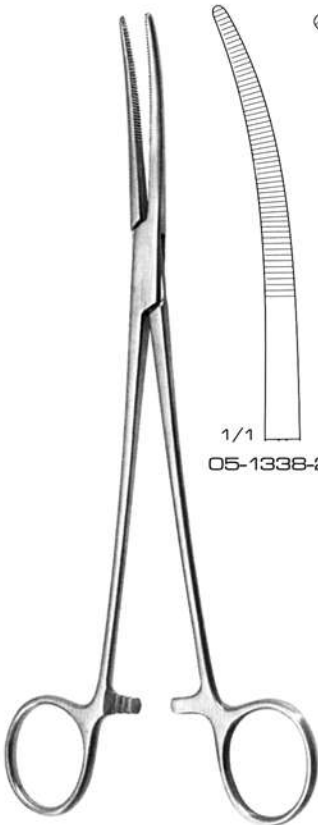

Rumel
23 cm / 9"

1/1
05-1338-23

1/1
05-1339-23

1/1
05-1340-23

1/1
05-1341-23

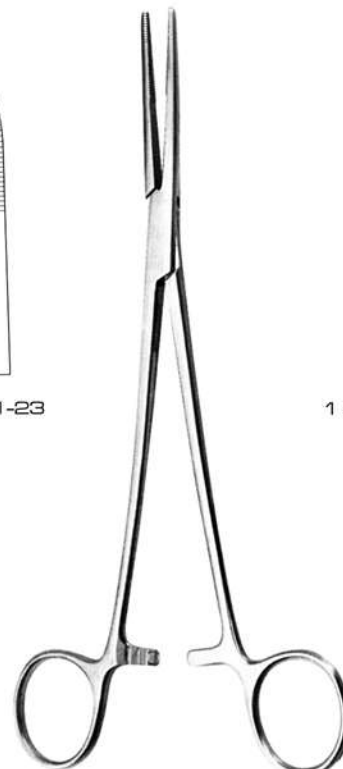

Toennis
21 cm / 8¼"

1/1
05-1342-21

1/1
05-1343-21

1 X 2 th
1/1
05-1344-21

1/1
05-1345-21

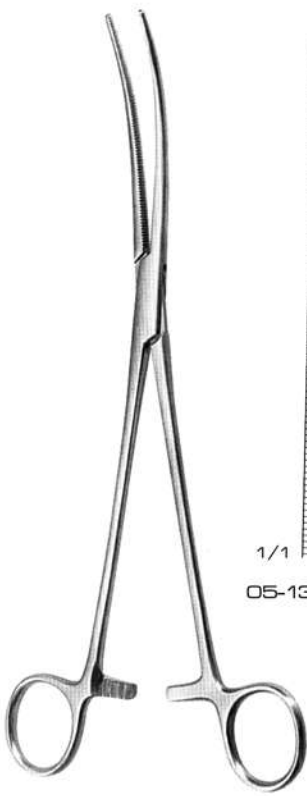

Sarot
24 cm / 9½"

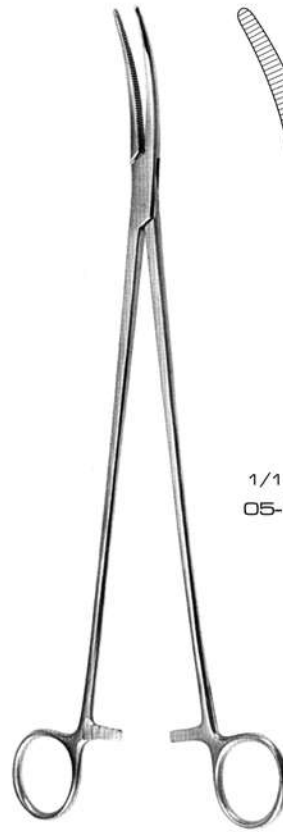
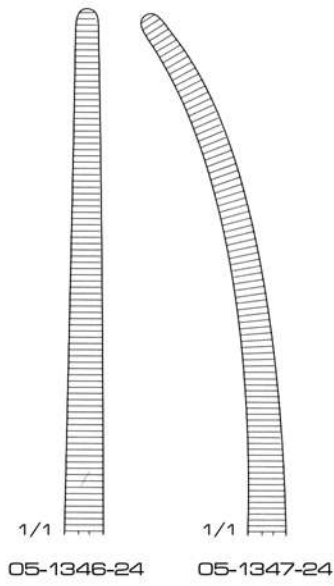

Zenker
29.5 cm / 11¾"

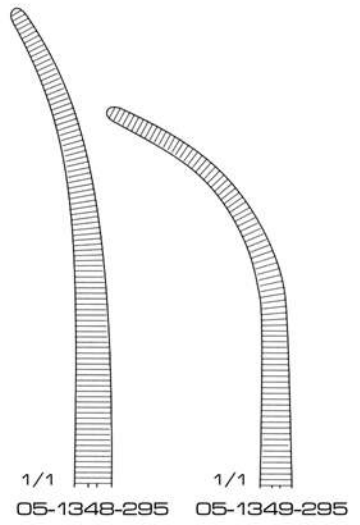

Crafoord-Sellers

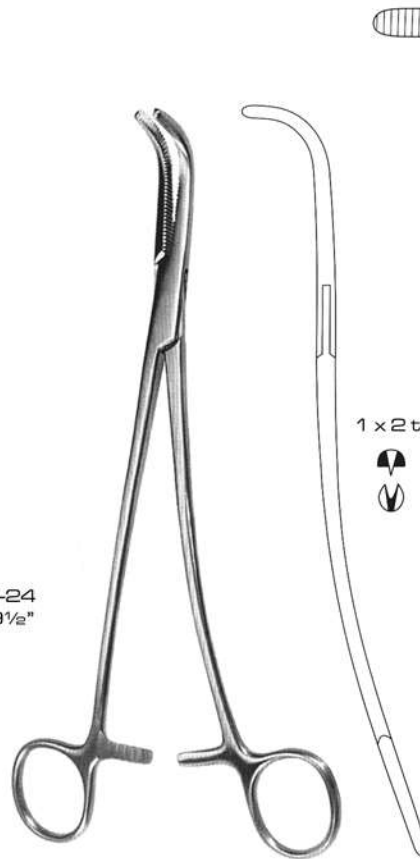
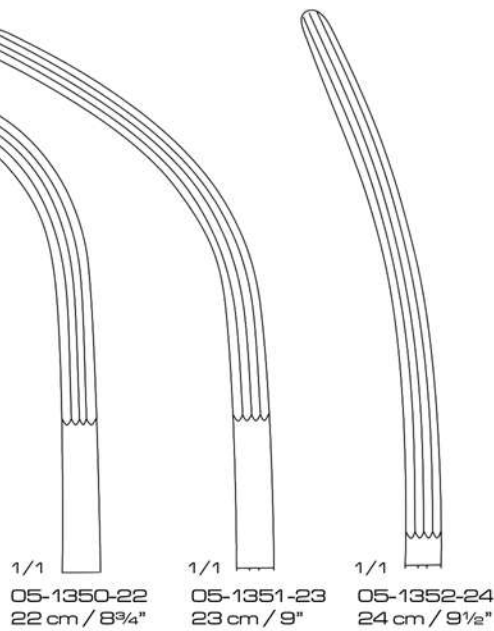

Gray

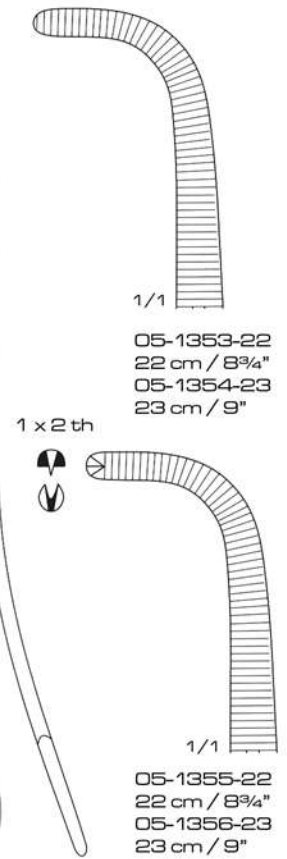

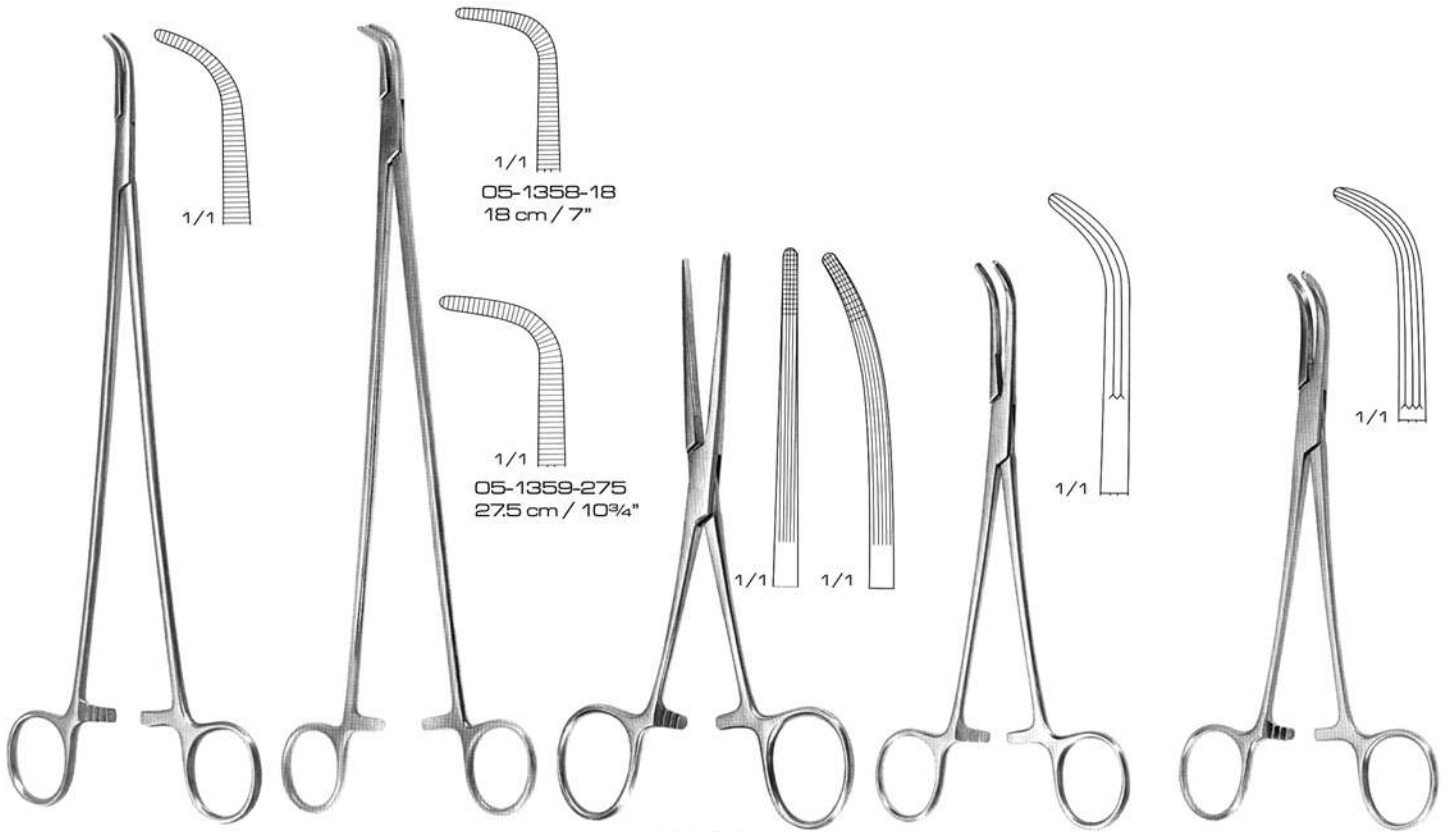

Lawrence
05-1357-275
27.5 cm / 10¾"

Meeker

05-1358-18
18 cm / 7"

05-1359-275
27.5 cm / 10¾"

Bainbridge

(str)
05-1360-15
15 cm / 6"
05-1361-18
18 cm / 7"

(cur)
05-1362-15
15 cm / 6"
05-1363-18
18 cm / 7"

Lahey
05-1364-19
19 cm / 7½"
05-1365-23
23 cm / 9"

Lower
05-1366-18
18 cm / 7"



Mixer
05-1367-15 15 cm / 6"
05-1368-19 19 cm / 7½"

Mixer
05-1369-23
23 cm / 9"

Baby-Mixer
05-1370-18
18 cm / 7"

Mixer
05-1371-22 22 cm / 8¾"
05-1372-25 25 cm / 10"
05-1373-28 28 cm / 11"

BRONCHUS, GALL DUCT AND KIDNEY PEDICLE CLAMPS

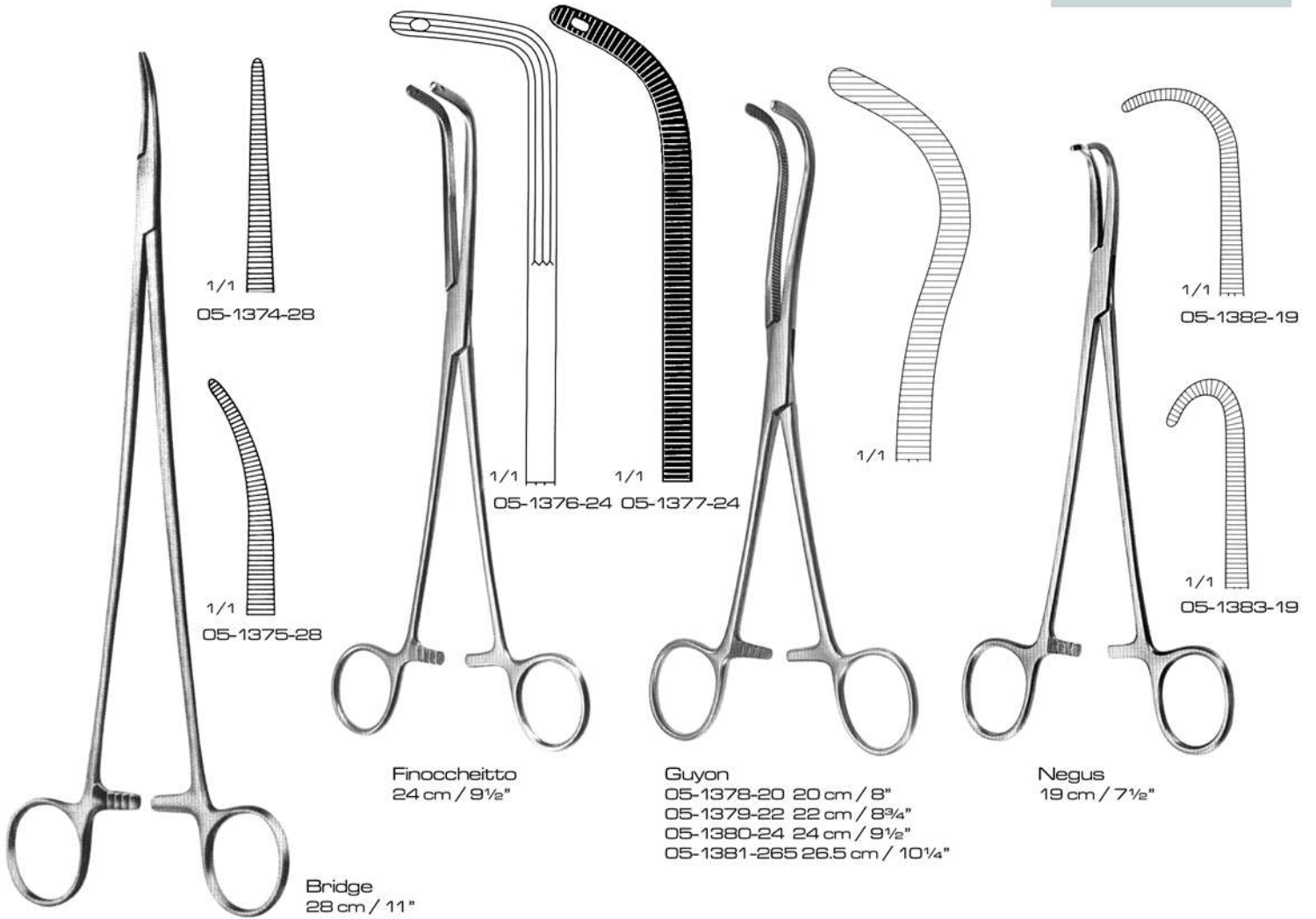

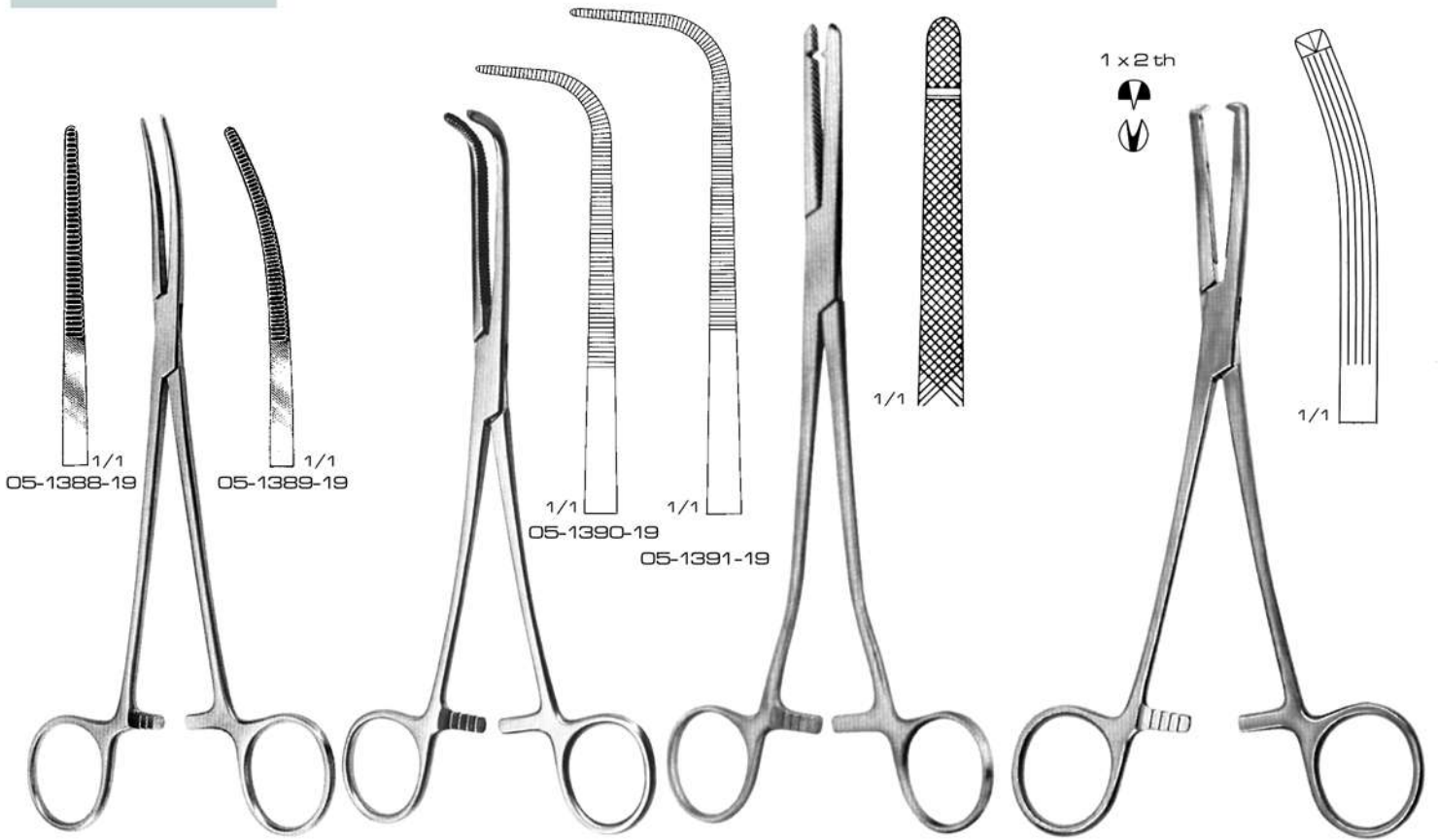

Birkett
19 cm / 7½"

Wikstroem
19 cm / 7½"

Heaney-Rezak
05-1392-21
21 cm / 8¼"

Long
05-1393-19
19 cm / 7¼"

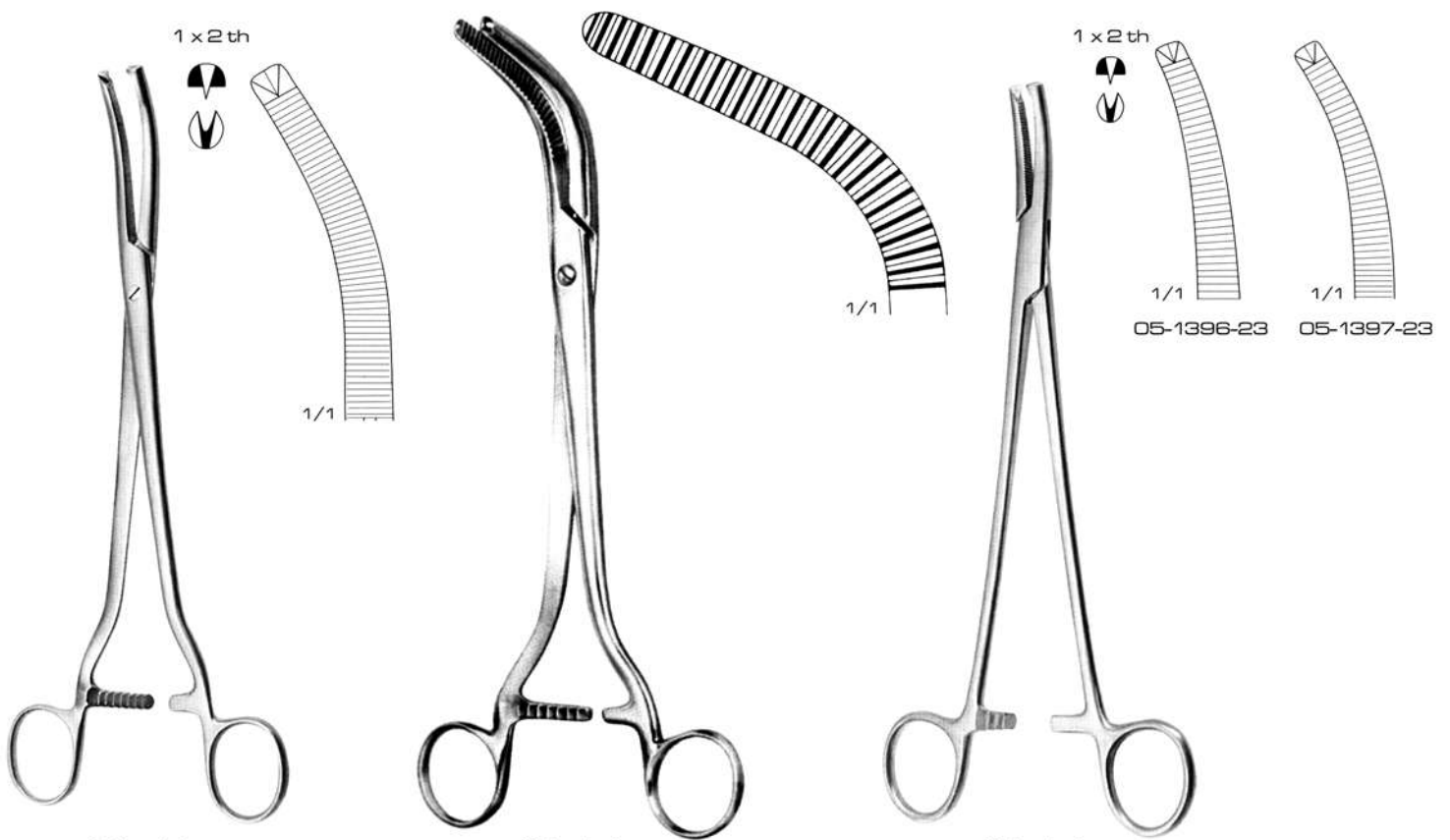

Wertheim
05-1394-24
24 cm / 9½"

Wertheim
05-1395-27
27 cm / 11"

Wertheim
23 cm / 9"

HYSTERECTOMY FORCEPS

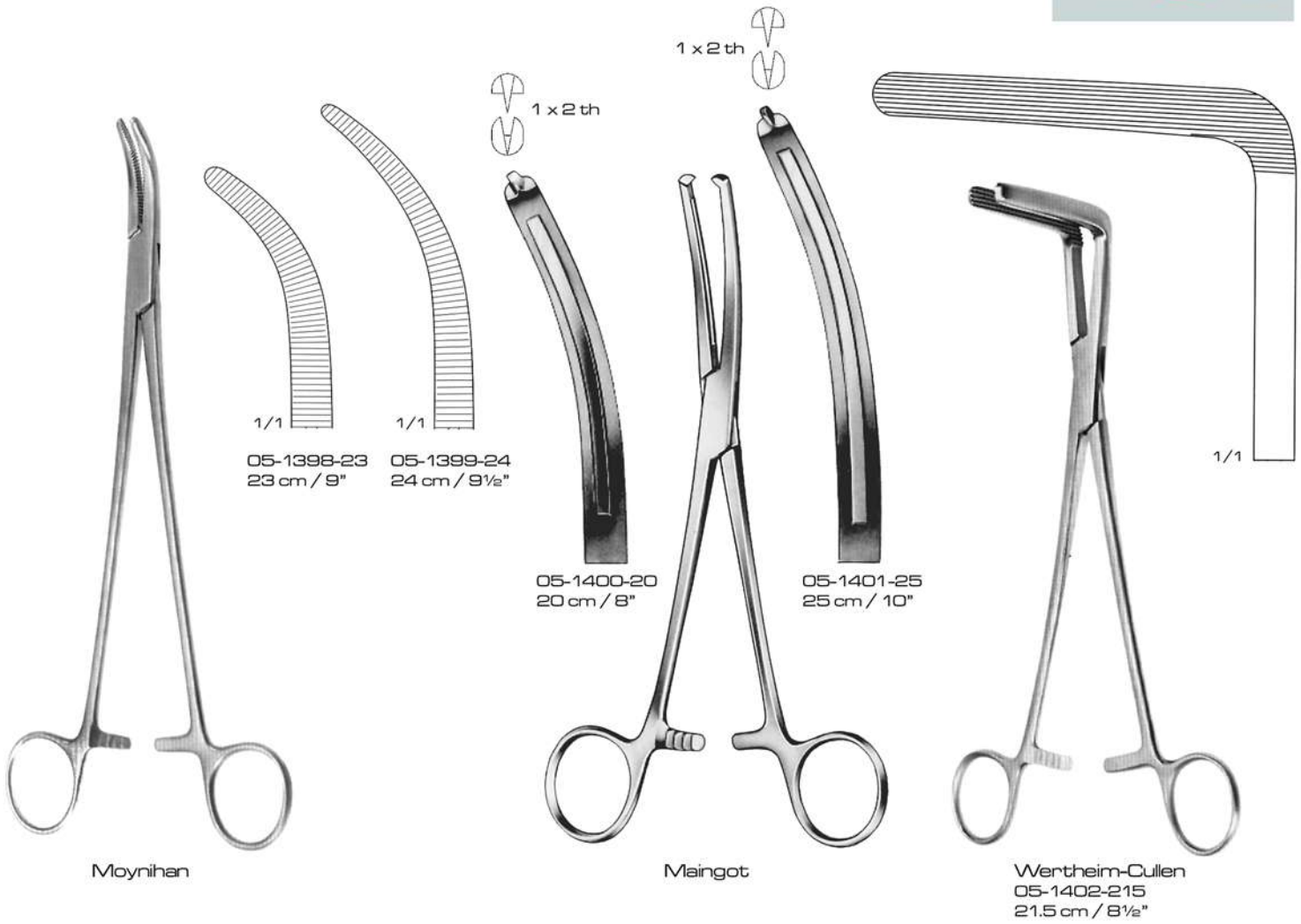

Moynihan

Maingot

Wertheim-Cullen
05-1402-215
21.5 cm / 8 1/2"

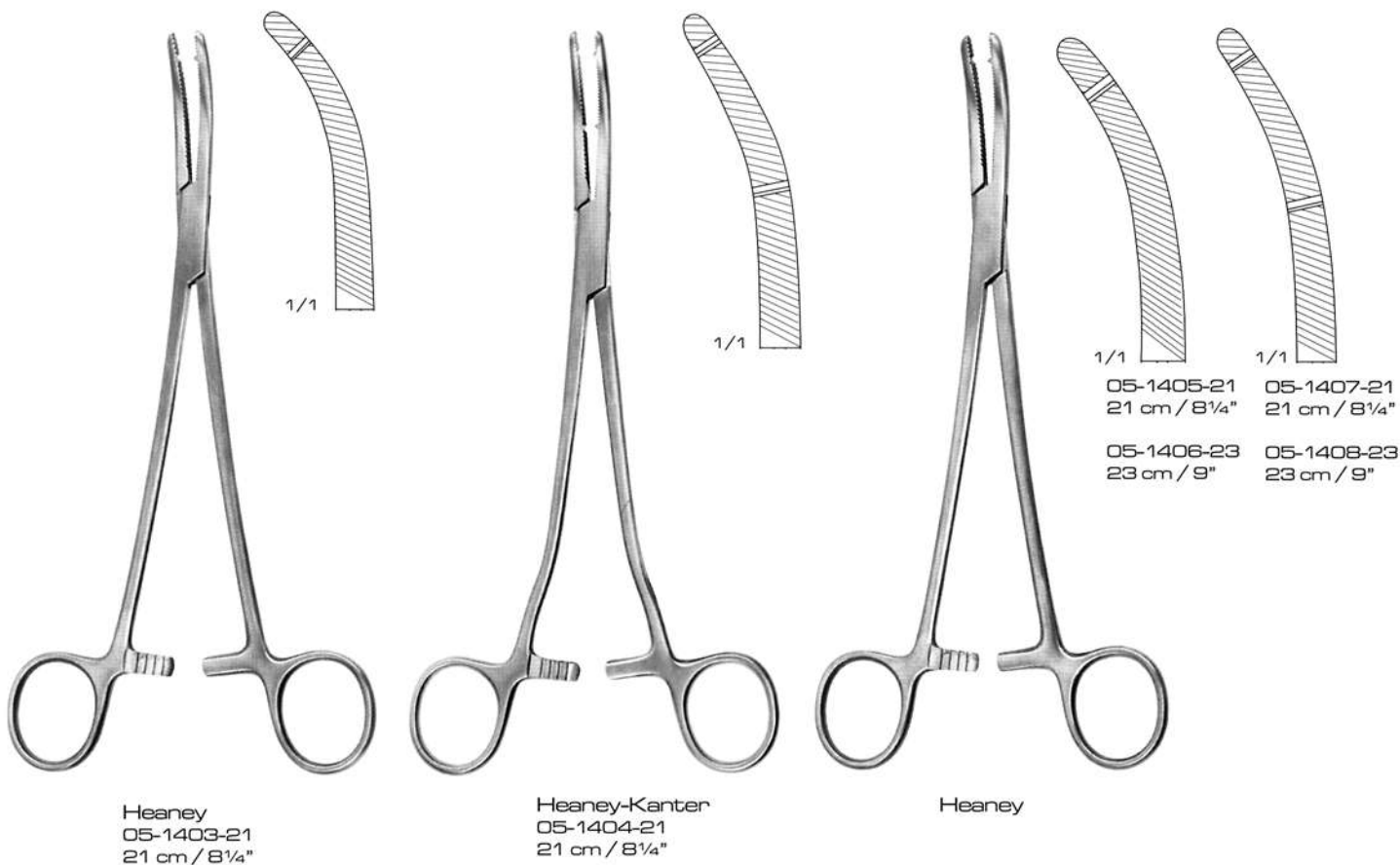

Heaney
05-1403-21
21 cm / 8 1/4"

Heaney-Kanter
05-1404-21
21 cm / 8 1/4"

Heaney

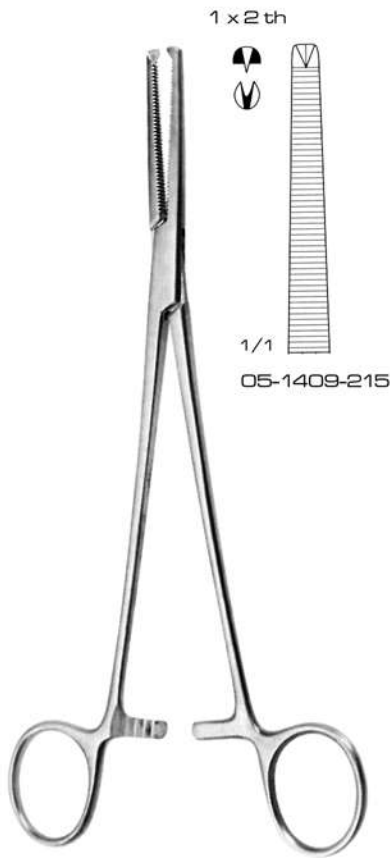

Phaneuf
21.5 cm / 8½"

1 x 2 th



1/1

05-1409-215

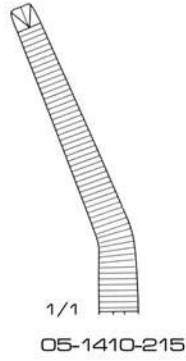

1/1

05-1410-215

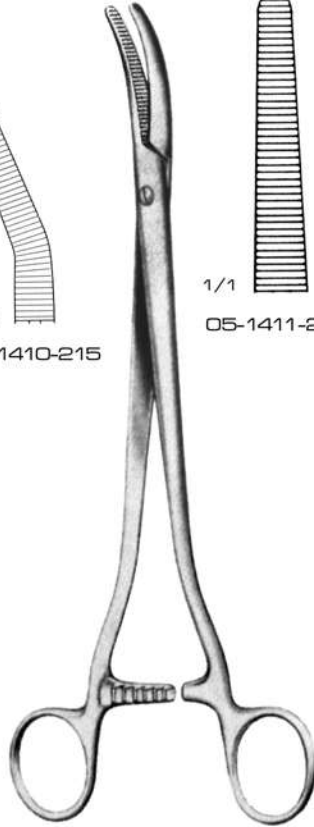

1/1

05-1411-24

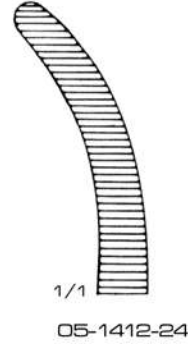

1/1

05-1412-24

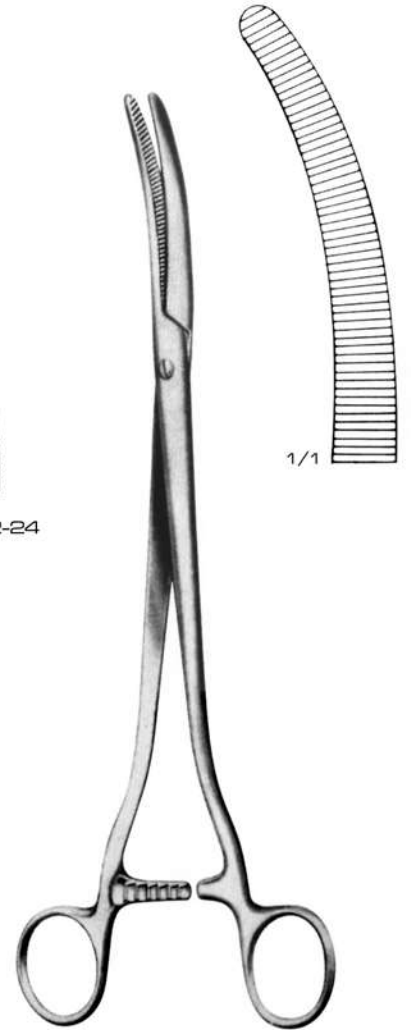

1/1

Faure
05-1413-25
25 cm / 10"

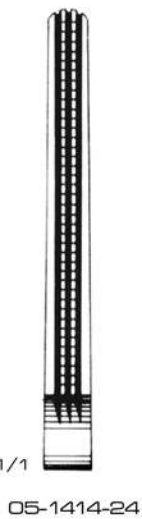

1/1

05-1414-24



1/1

05-1415-24



1/1

05-1416-24



1/1

05-1417-24

Wertheim-De-Bakey
24 cm / 9½"

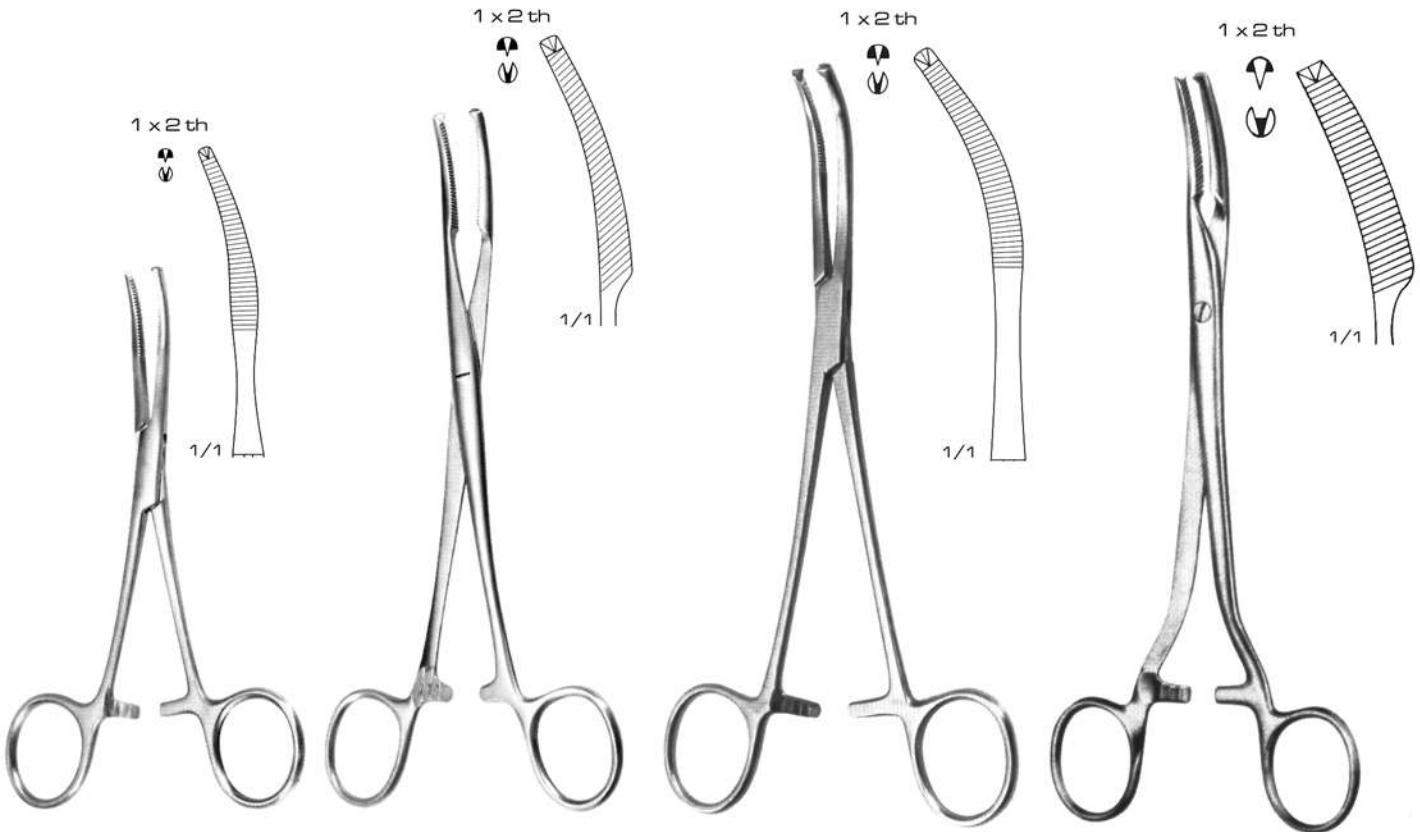

Baby-Milkulicz
05-1418-14
14 cm / 5½"

Milkulicz
05-1419-18
18 cm / 7"

Milkulicz
05-1420-20
20 cm / 8"

Milkulicz
05-1421-205
20.5 cm / 8"

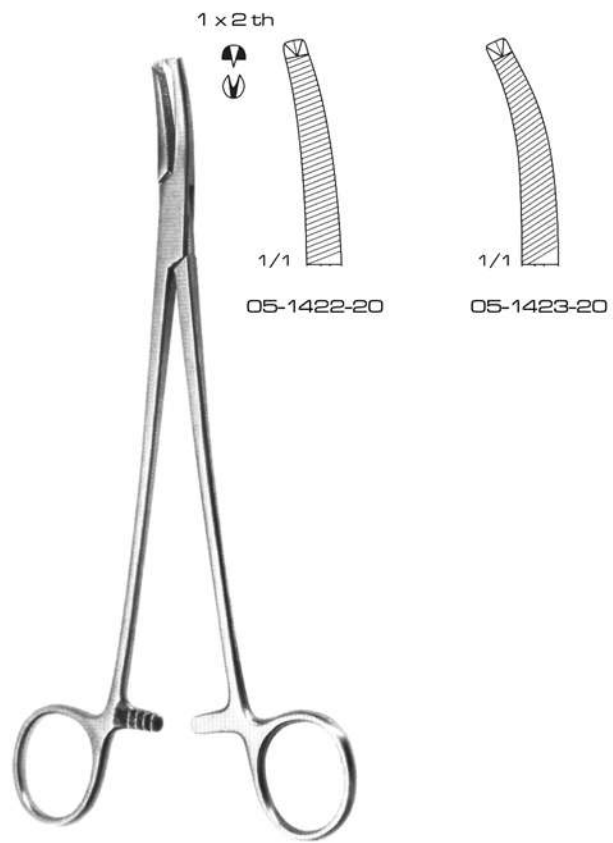

Faure
20 cm / 8"

Schindler
05-1424-20
20 cm / 8"

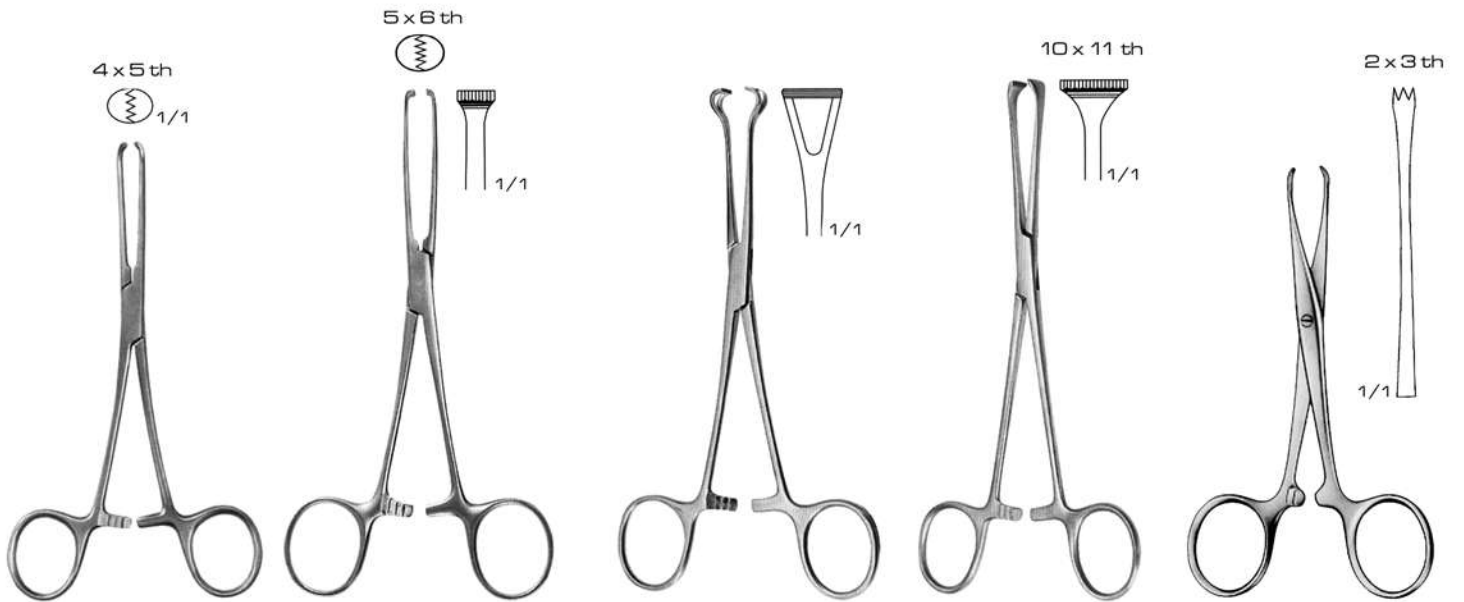

Allis-Baby
05-1425-12
12 cm / 4¾"

05-1426-15
15 cm / 6"

Allis-Baby
05-1427-15
15 cm / 6" (4 x 5 th)

05-1428-19
19 cm / 7½" (5 x 6 th)

05-1429-25
25 cm / 10" (5 x 6 th)

Babcock
05-1430-16
16 cm / 6¼"

05-1431-18
18 cm / 7"

05-1432-20
20 cm / 8"

05-1433-24
24 cm / 9½"

Allis-Adair
05-1434-155
15.5 cm / 6"

Chaput
05-1435-125
12.5 cm / 5"

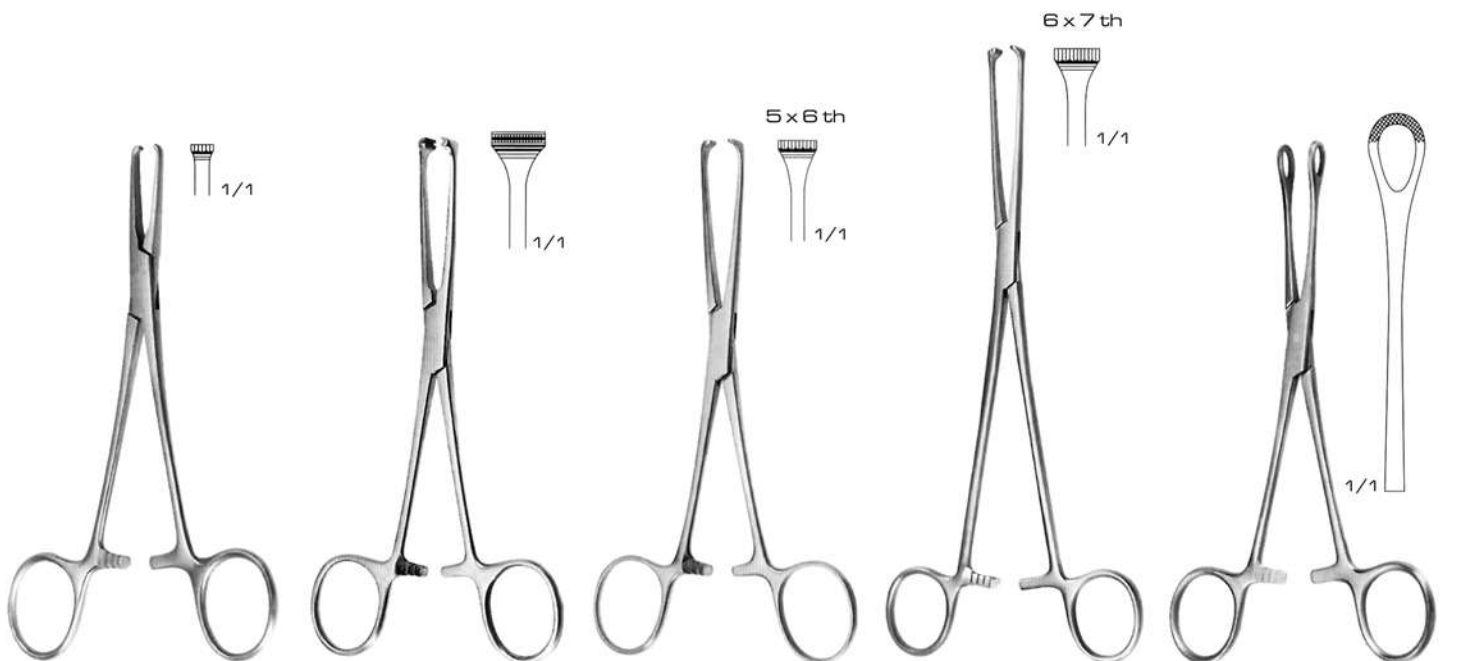

Judd-Allis
05-1436-15
15 cm / 6"

05-1437-19
19 cm / 7½"

Allis-Atrauma
05-1438-16
16 cm / 6¼"

05-1439-20
20 cm / 8"

05-1440-25
25 cm / 10"

05-1441-30
30 cm / 12"

Boys-Allis
05-1442-155
15.5 cm / 6"

Thoms-Allis
05-1443-20
20 cm / 8"

Williams
05-1444-16
16 cm / 6¼"

TISSUE AND ORGAN HOLDING / GRASPING FORCEPS AND INTESTINAL CLAMPS

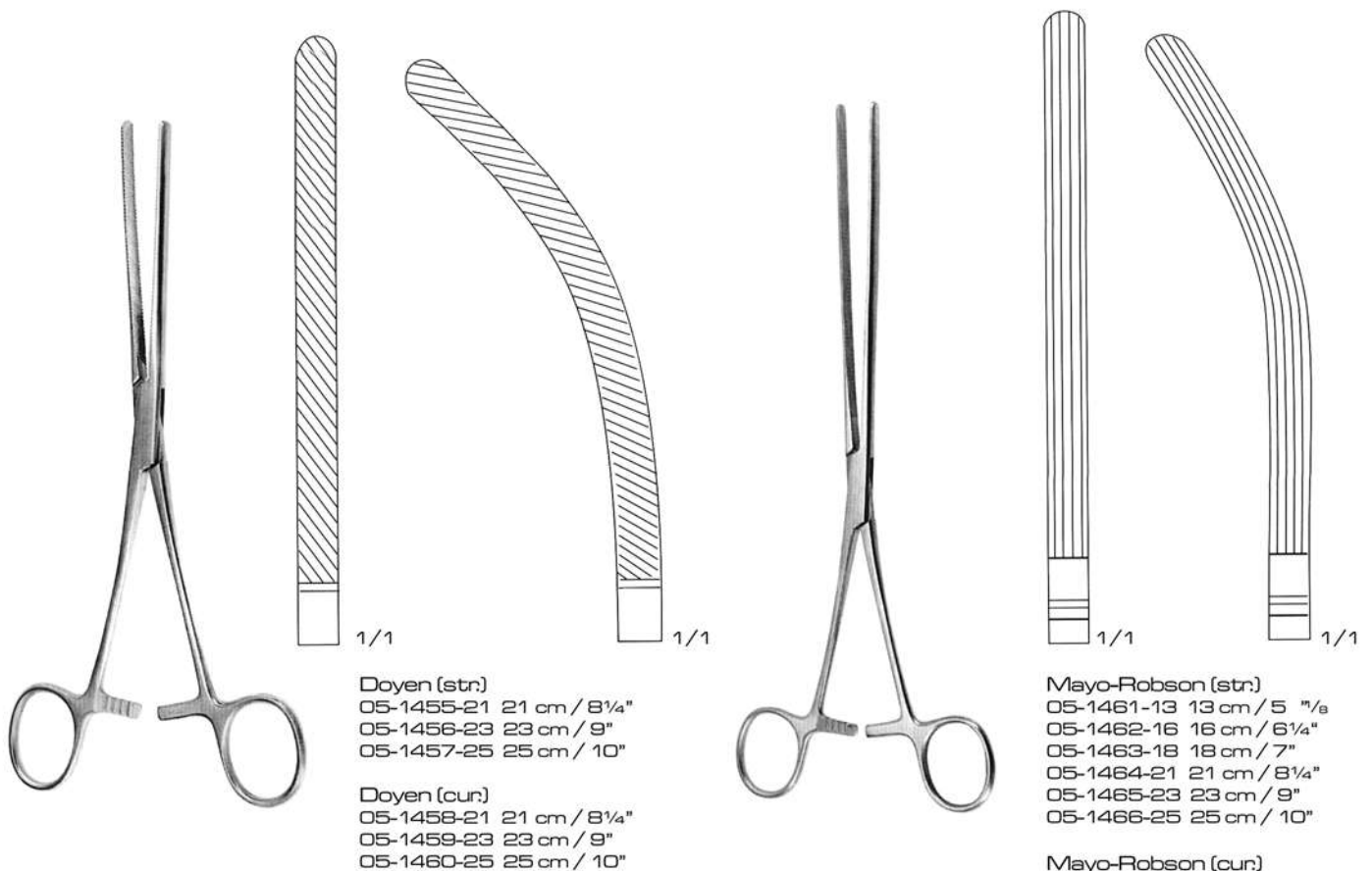
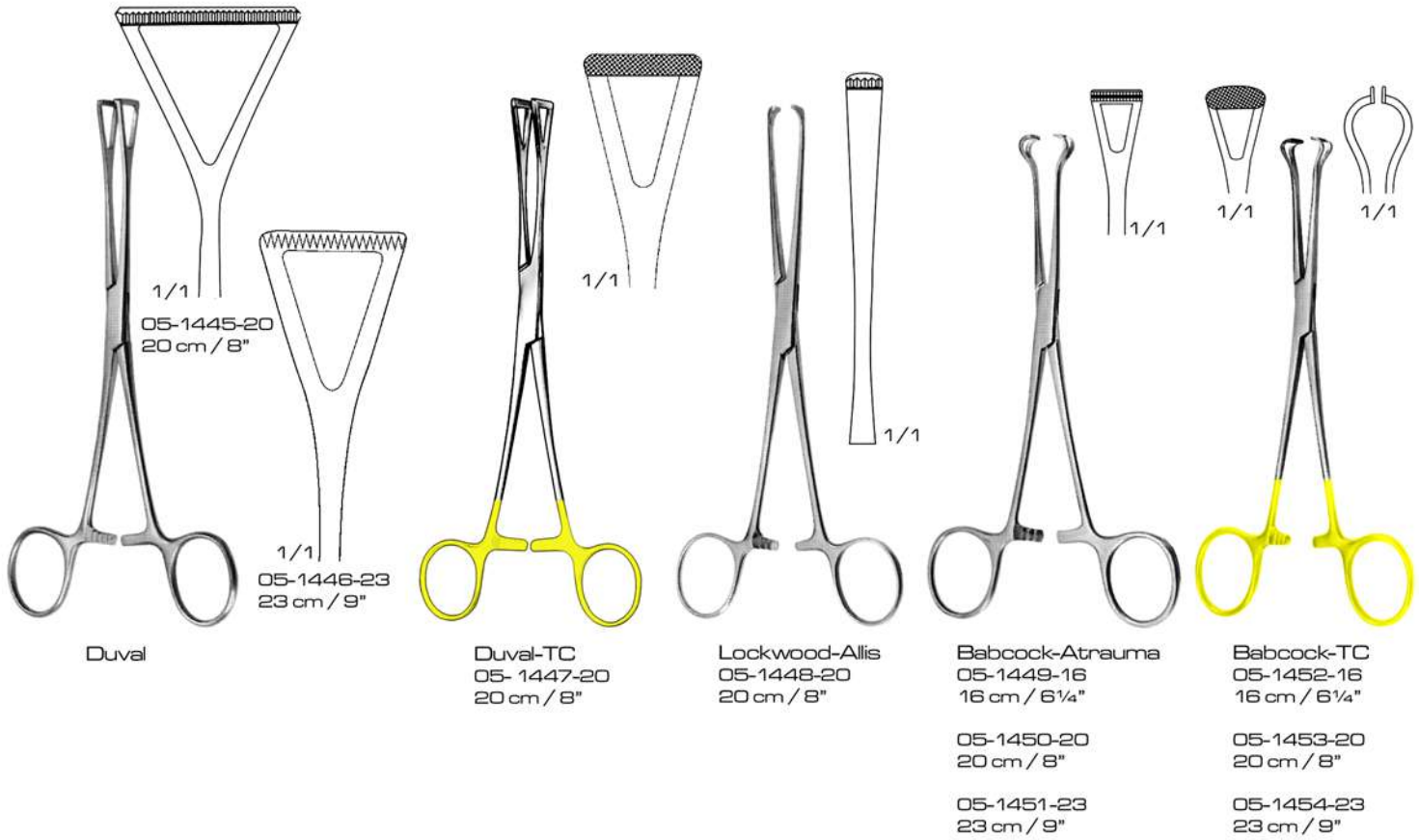

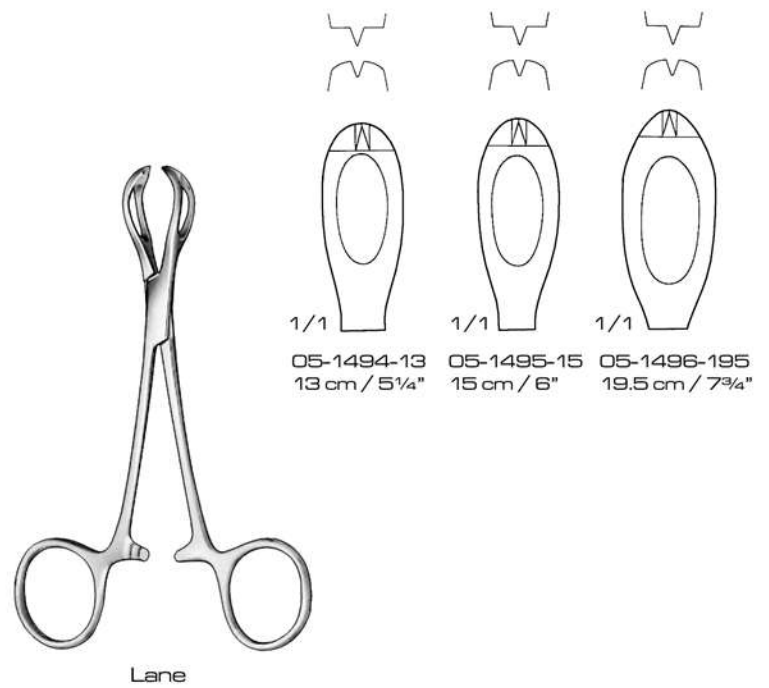
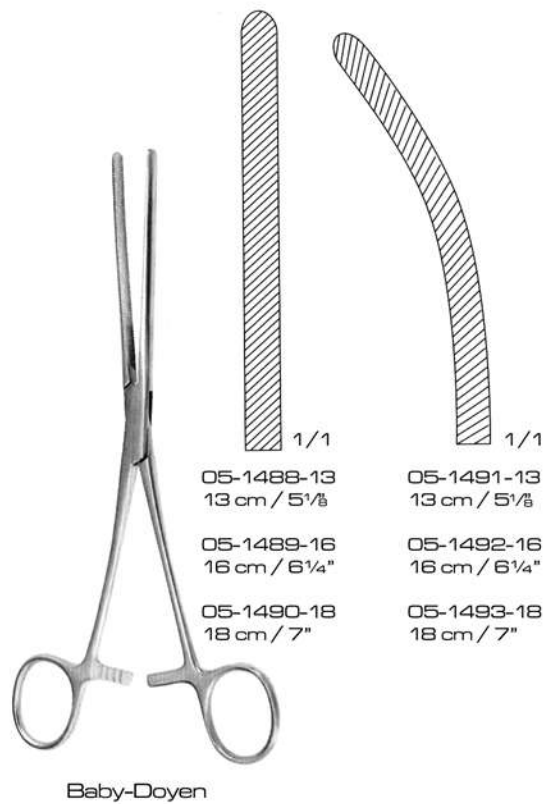
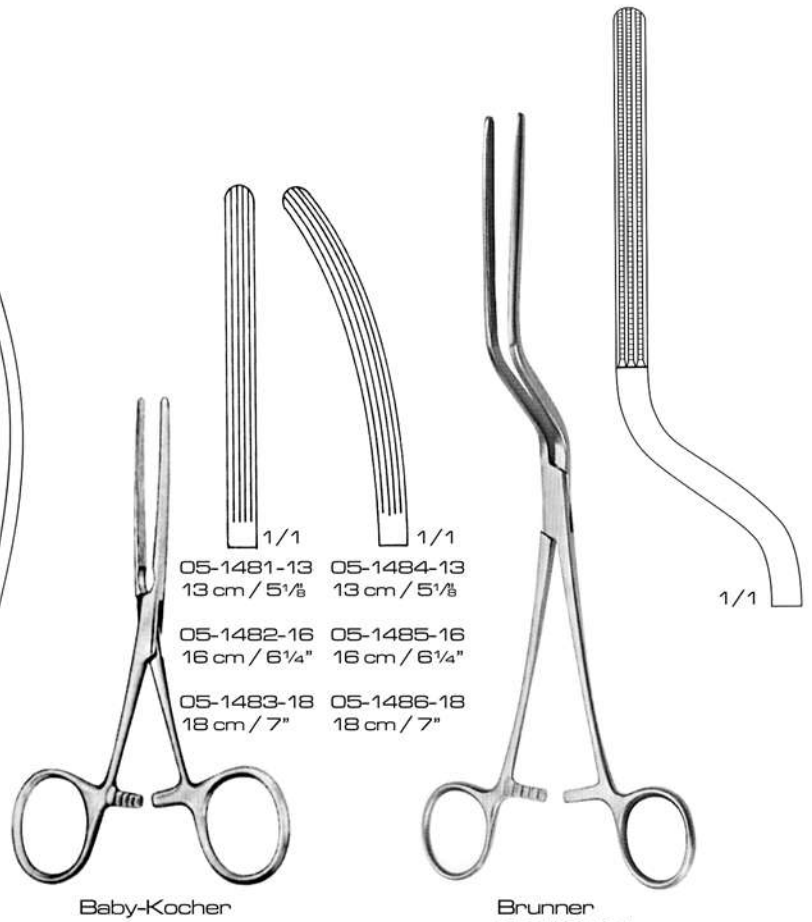
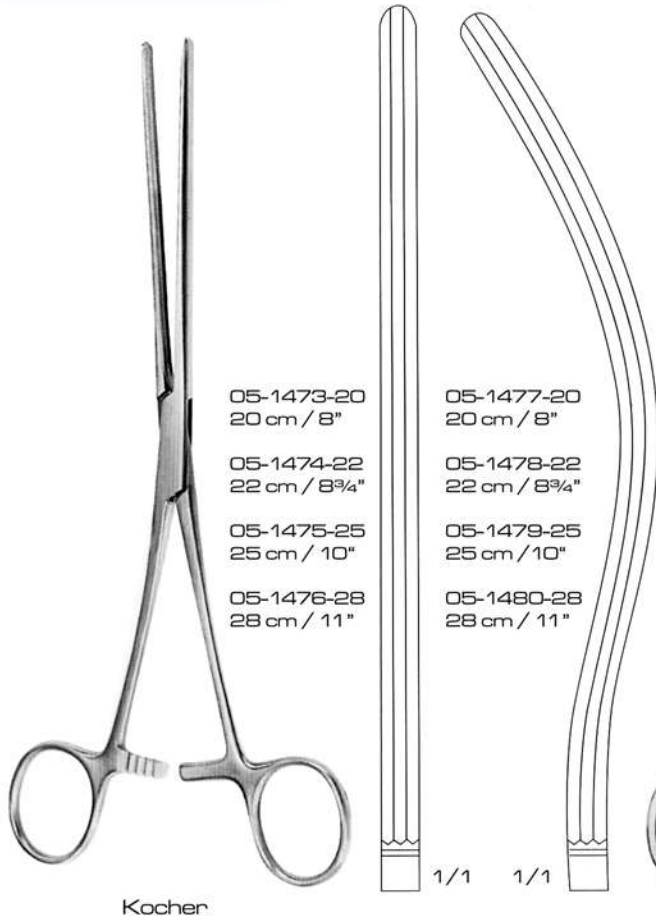



23 cm / 9"



05-1497-23
60 mm



05-1498-23
80 mm

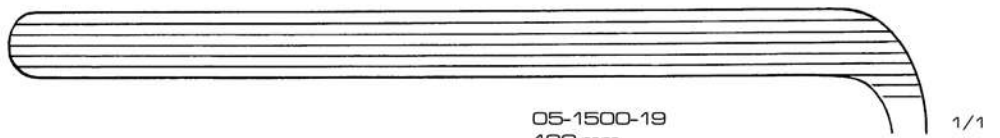

05-1500-19
120 mm

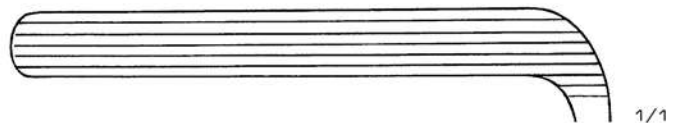

05-1501-19
80 mm

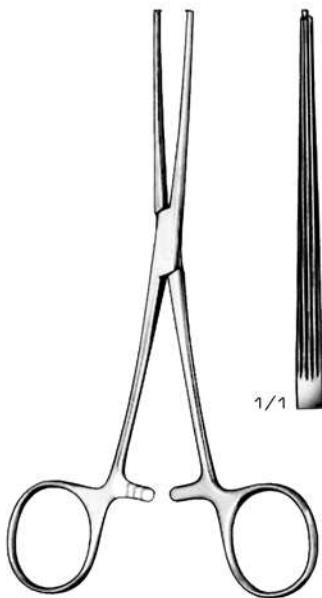

Allen
05-1499-15
15 cm / 6"



Milkulicz
19 cm / 7 1/2"

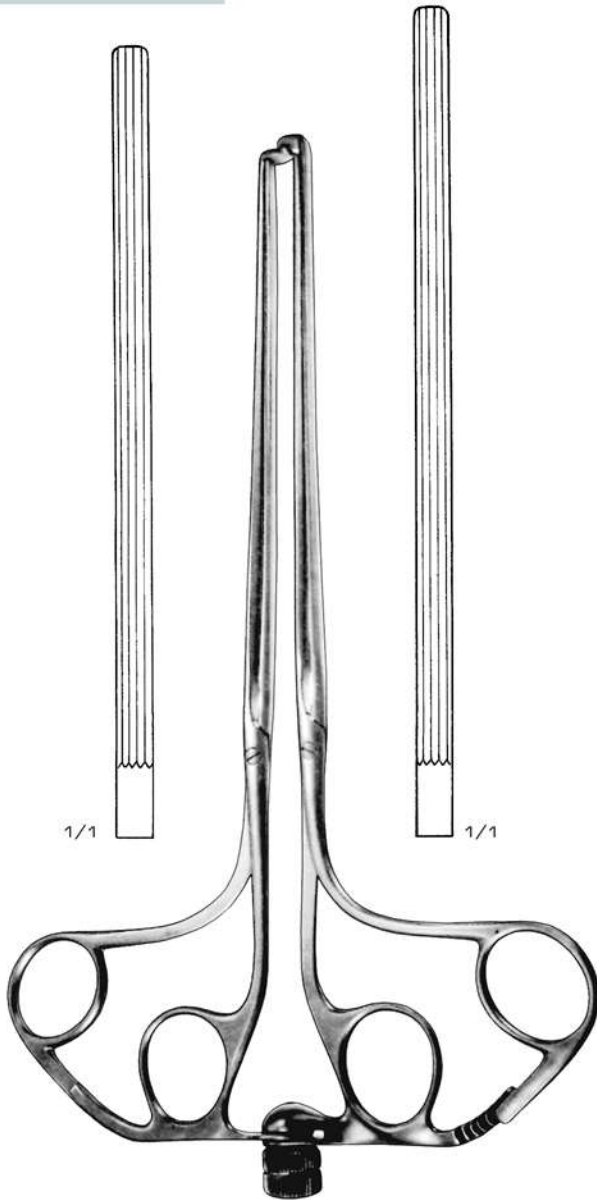

Abadie
05-1502-22 22 cm / 8³/₄"
05-1503-27 27 cm / 10¹/₂"

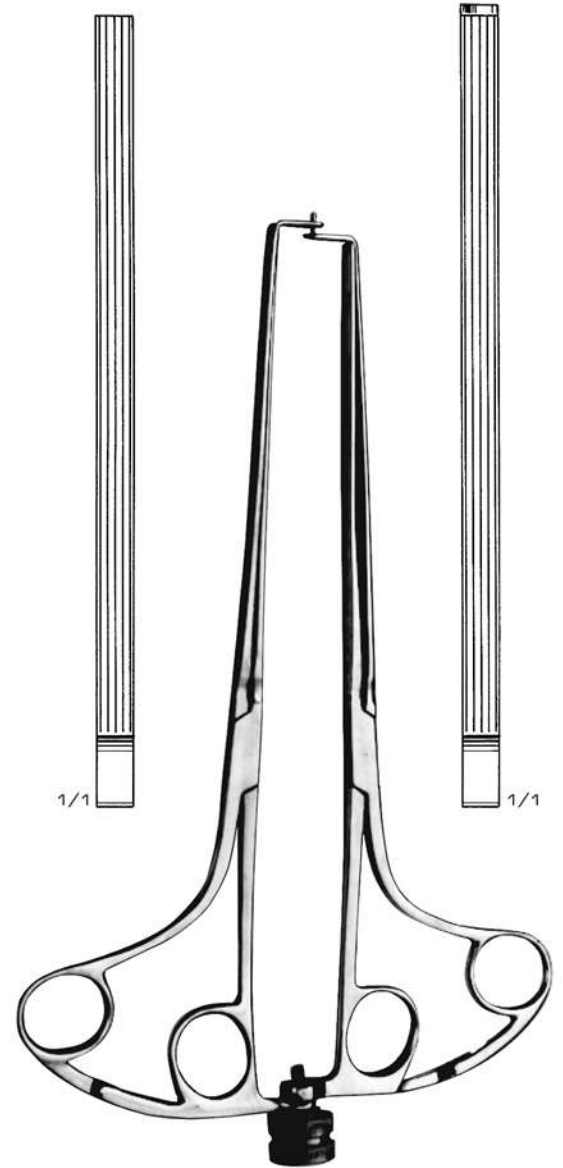

Abadie
05-1504-22 22 cm / 8³/₄"
05-1505-27 27 cm / 10¹/₂"



Kleinschmidt
05-1506-13
13 cm / 5"
Appendectomy clamp

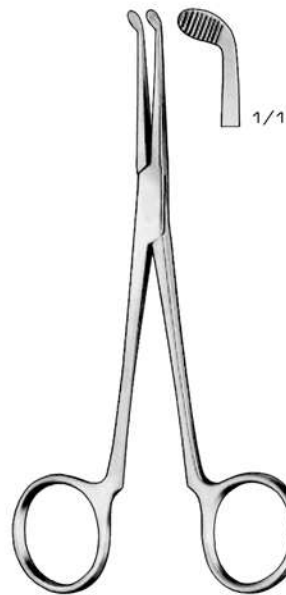

Benson
05-1507-15
15 cm / 6"
Pylorus spreader

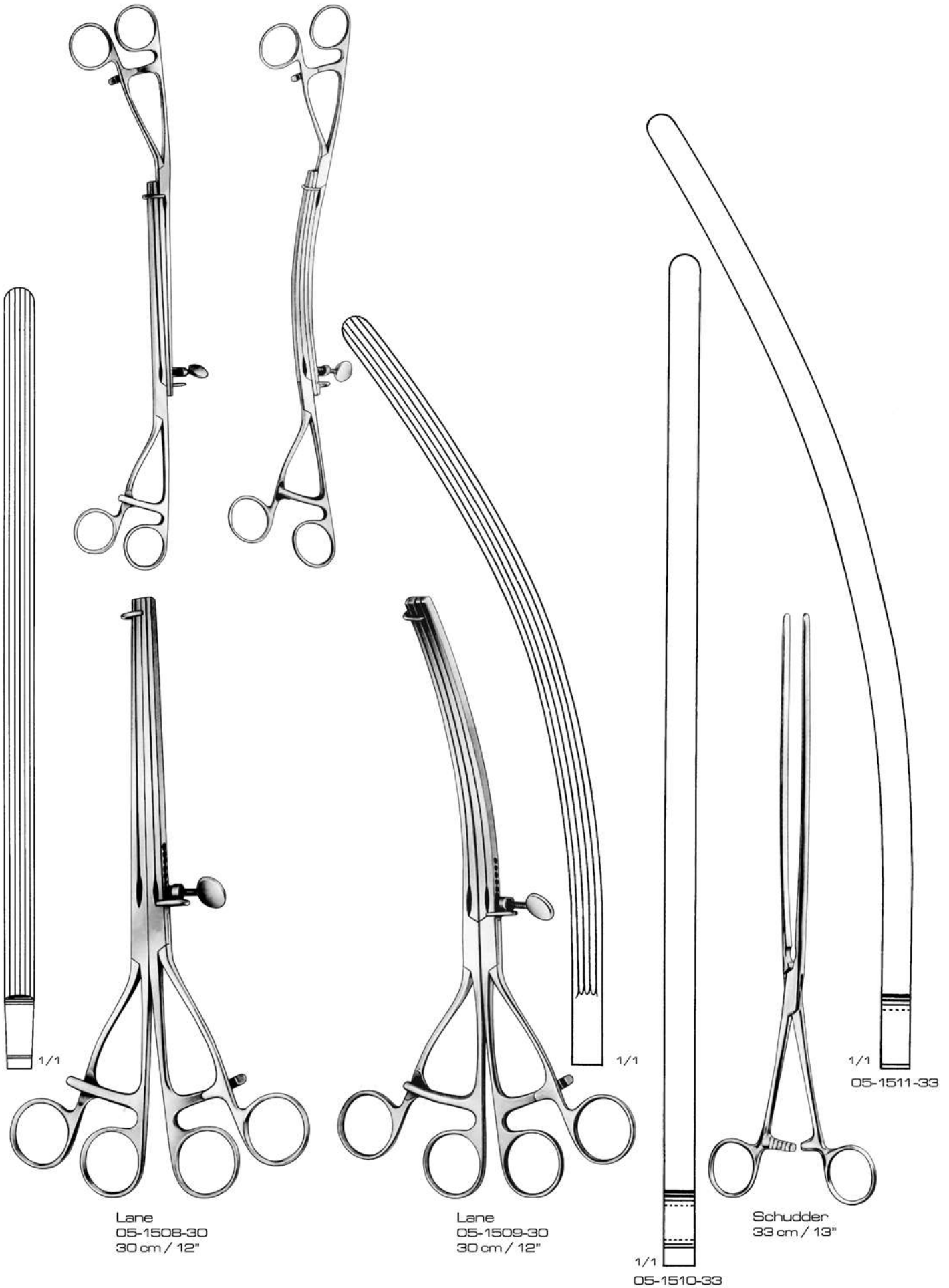

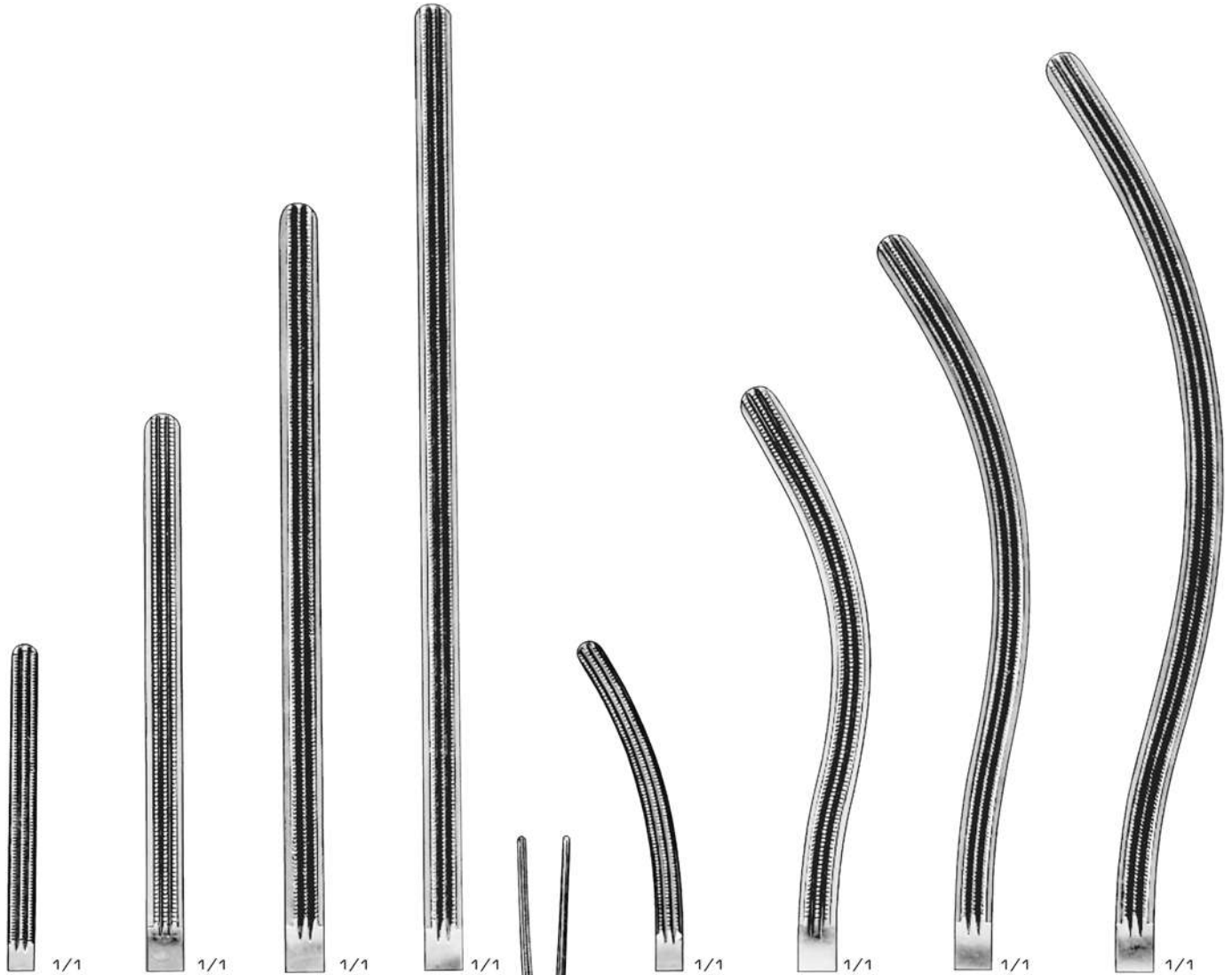

05-1512-13 13 cm / 5 1/8"	05-1513-22 22 cm / 8 3/4"	05-1514-25 25 cm / 10"	05-1515-28 28 cm / 11"	05-1516-13 13 cm / 5 1/8"	05-1517-22 22 cm / 8 3/4"	05-1518-25 25 cm / 10"	05-1519-28 28 cm / 11"
------------------------------	------------------------------	---------------------------	---------------------------	------------------------------	------------------------------	---------------------------	---------------------------

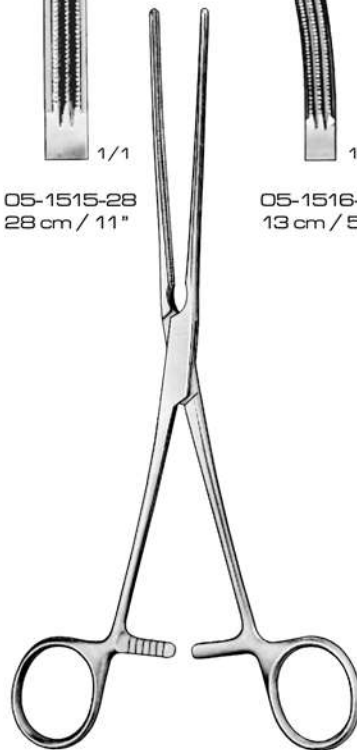

Kocher

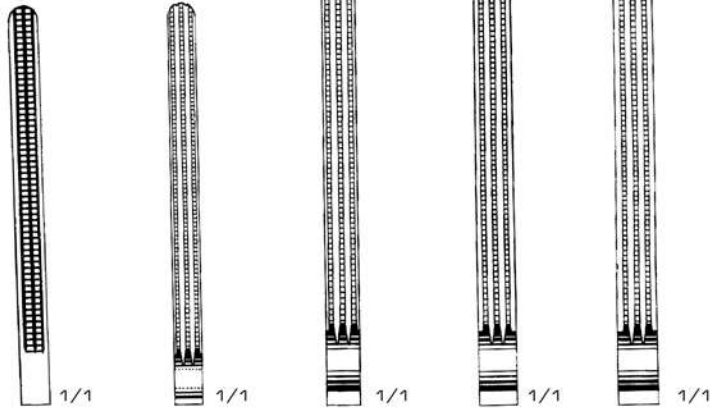

05-1520-13 13 cm / 5 1/8" 1/1
 05-1521-16 16 cm / 6 1/4" 1/1
 05-1522-18 18 cm / 7" 1/1
 05-1523-21 21 cm / 8 1/4" 1/1
 05-1524-23 23 cm / 9" 1/1

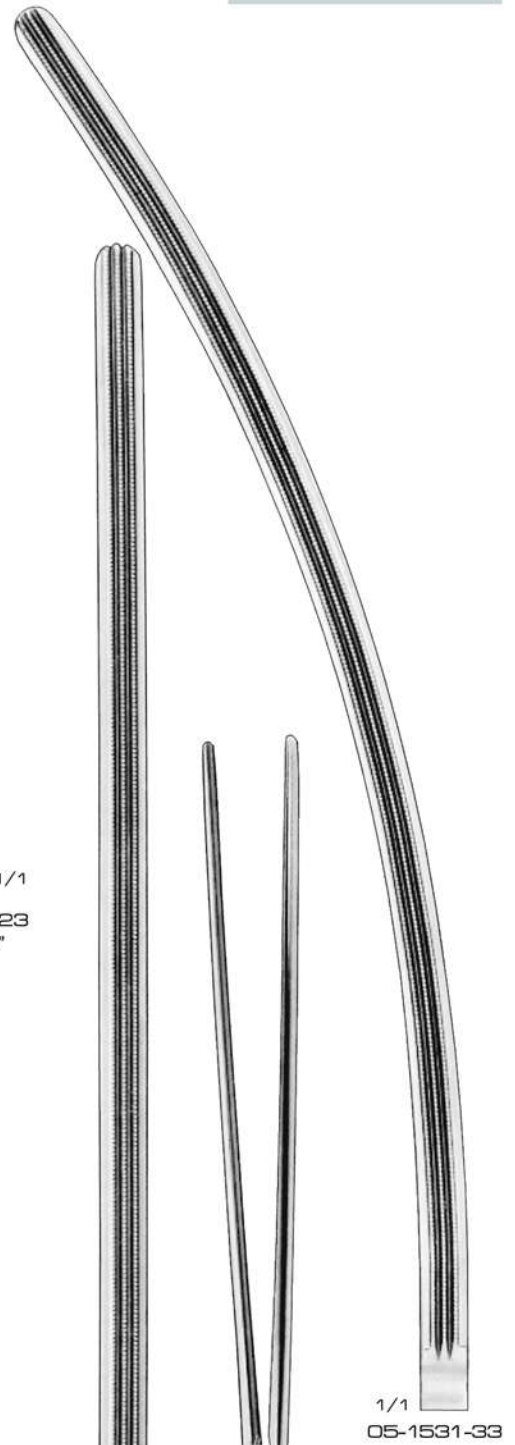

1/1
 05-1531-33

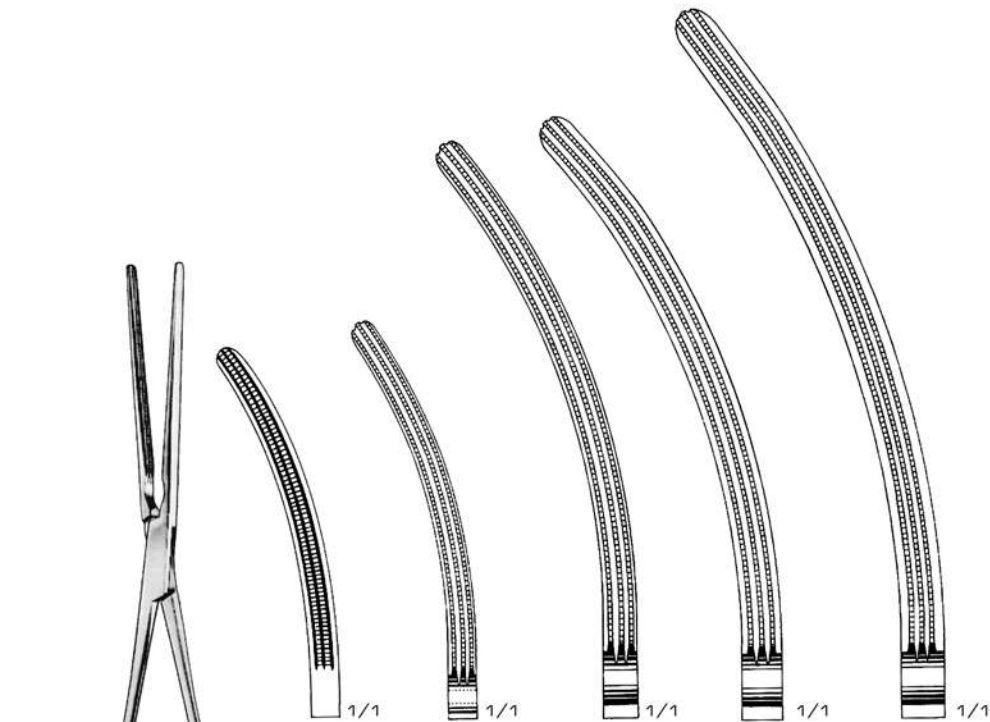

05-1525-13 13 cm / 5 1/8" 1/1
 05-1526-16 16 cm / 6 1/4" 1/1
 05-1527-18 18 cm / 7" 1/1
 05-1528-21 21 cm / 8 1/4" 1/1
 05-1529-23 23 cm / 9" 1/1

1/1
 05-1530-33

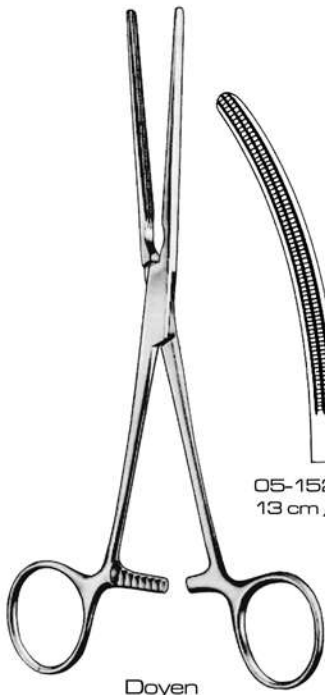

Doyen

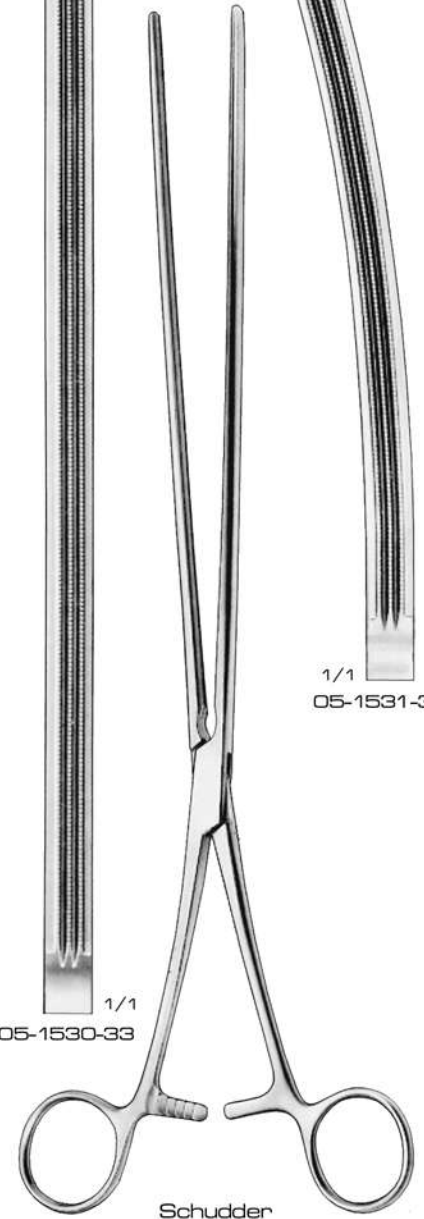

Schudder
 33 cm / 13"

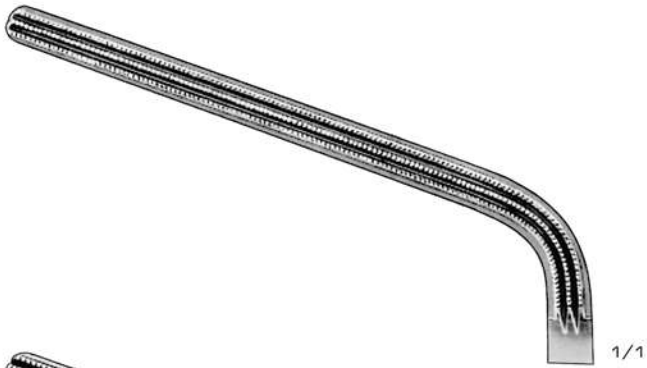

1/1
De Bakey (Morris Modif.)
05-1533-24
24 cm / 9½"

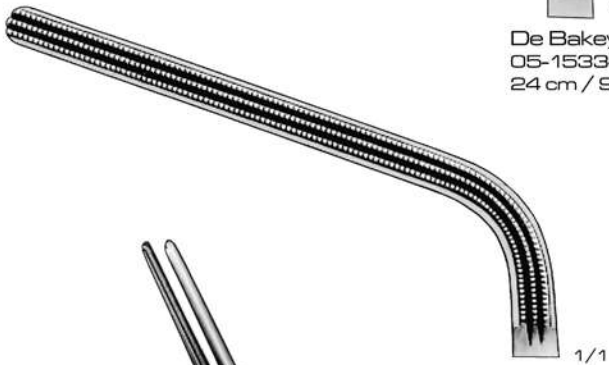

1/1
Morris
05-1532-18
18 cm / 7"

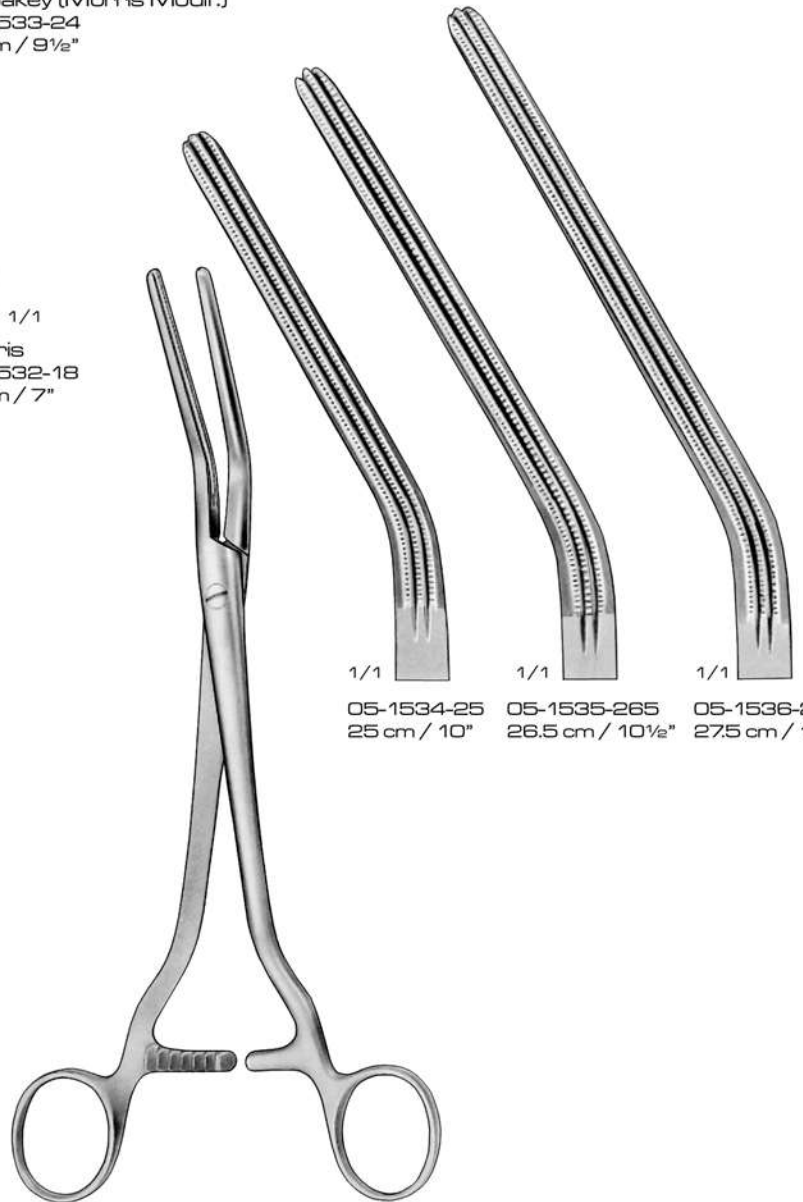

1/1 1/1 1/1
05-1534-25 05-1535-265 05-1536-275
25 cm / 10" 26.5 cm / 10½" 27.5 cm / 10¾"

Dick

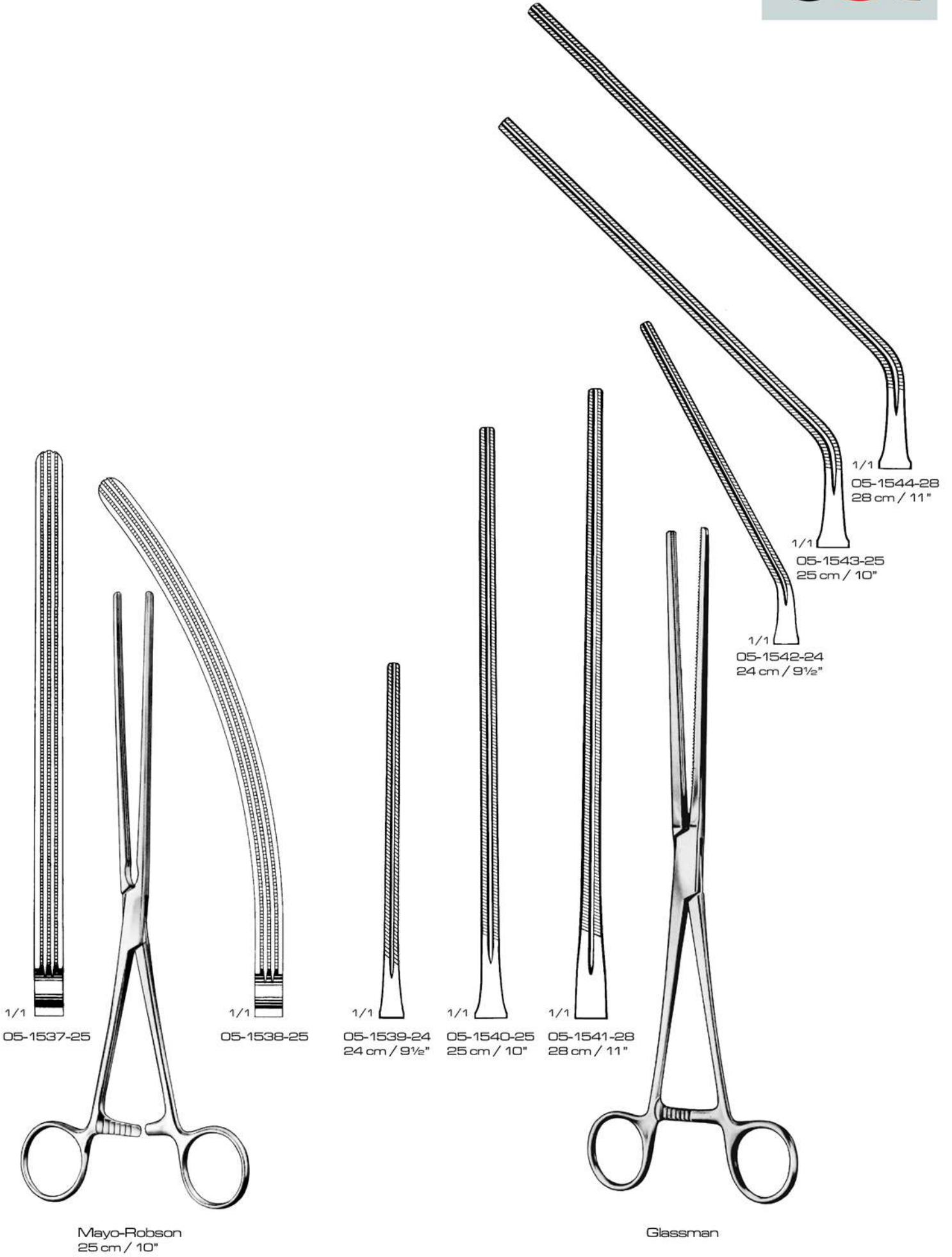



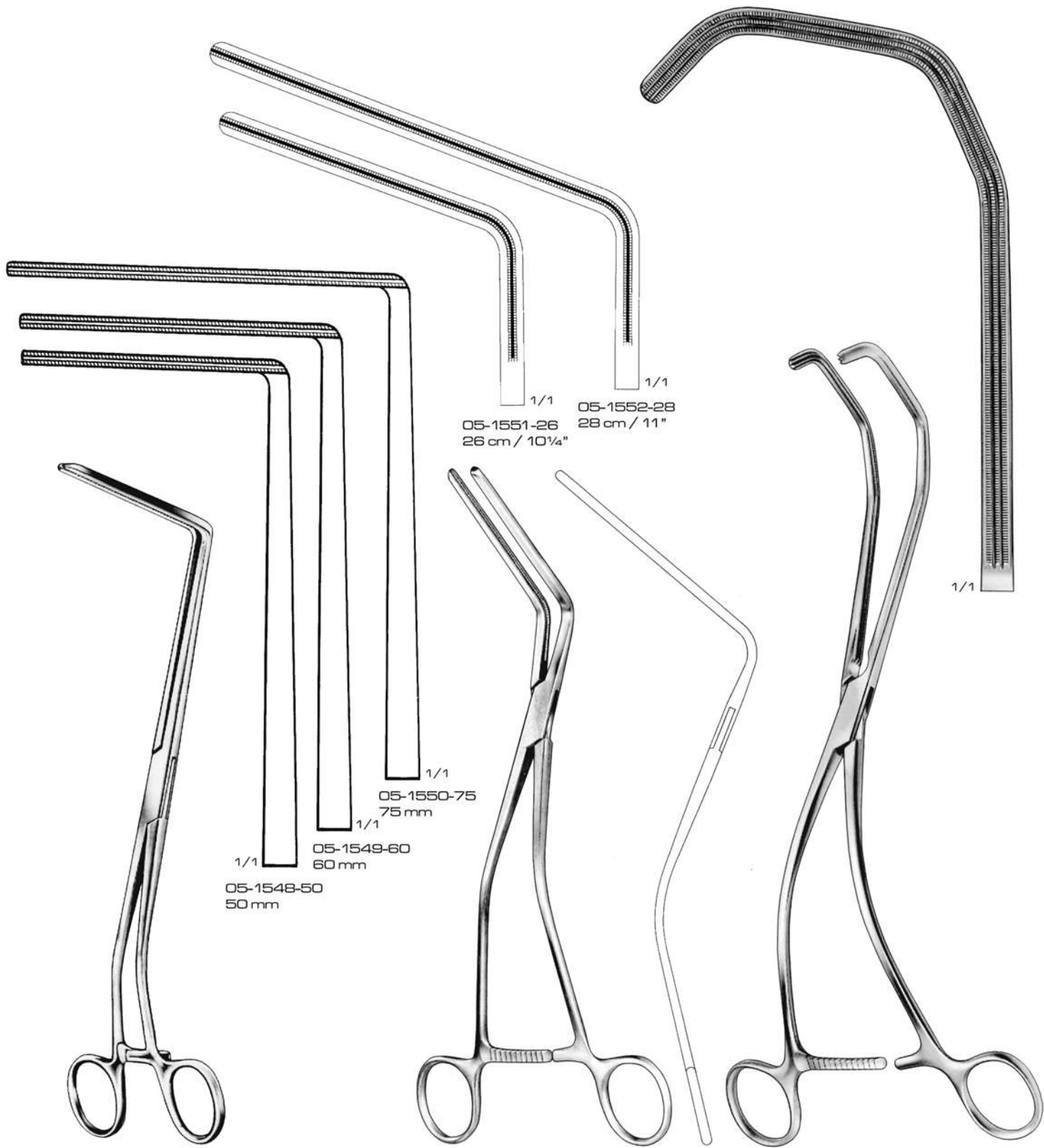

Glassman
24 cm / 9 1/2"

Hayes

Kersting
05-1553-27
27 cm / 10 1/2"



Bozemann
05-1554-26
26 cm / 10 1/4"

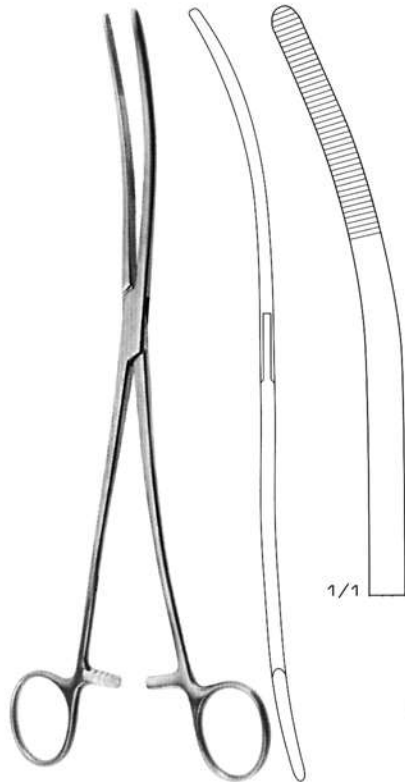

Bozemann
05-1555-26
26 cm / 10 1/4"



Bozemann-Douglas
05-1556-26
26 cm / 10 1/4"

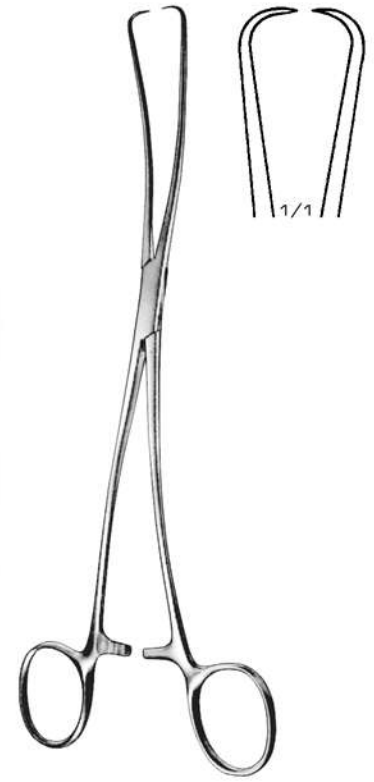

Duplay
05-1557-25
25 cm / 10"

05-1558-28
28 cm / 11"

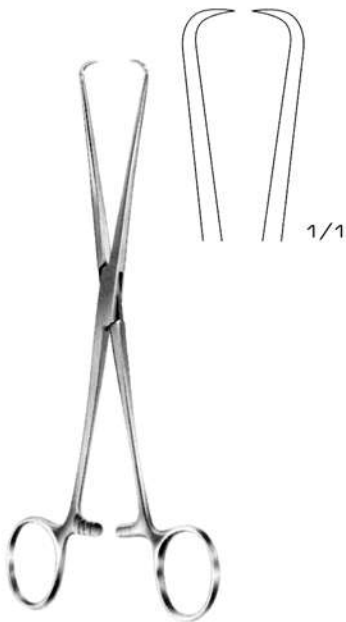

Barrett
05-1559-18
18 cm / 7"

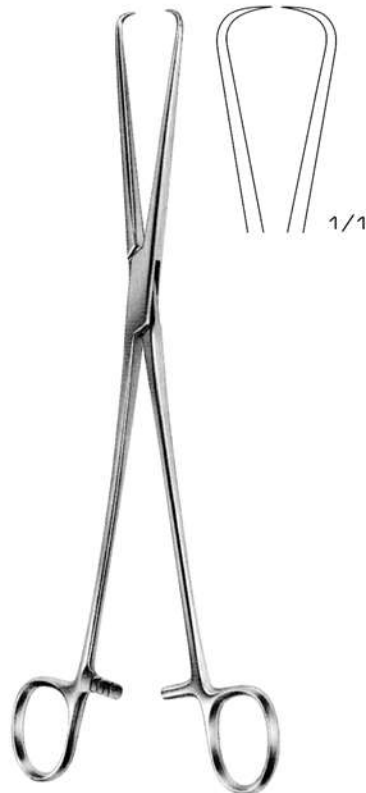

Schroeder
05-1560-25
25 cm / 10"

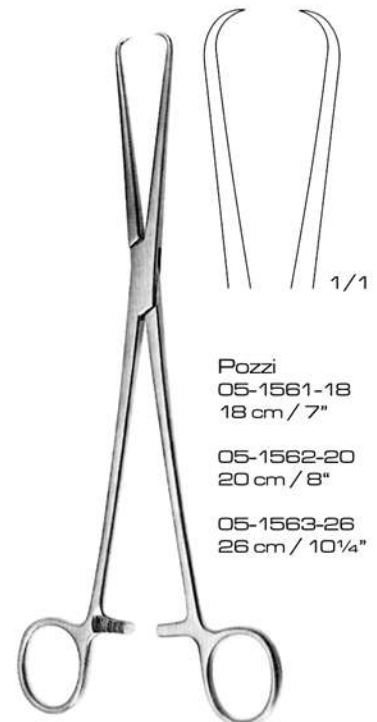

Pozzi
05-1561-18
18 cm / 7"

05-1562-20
20 cm / 8"

05-1563-26
26 cm / 10 1/4"

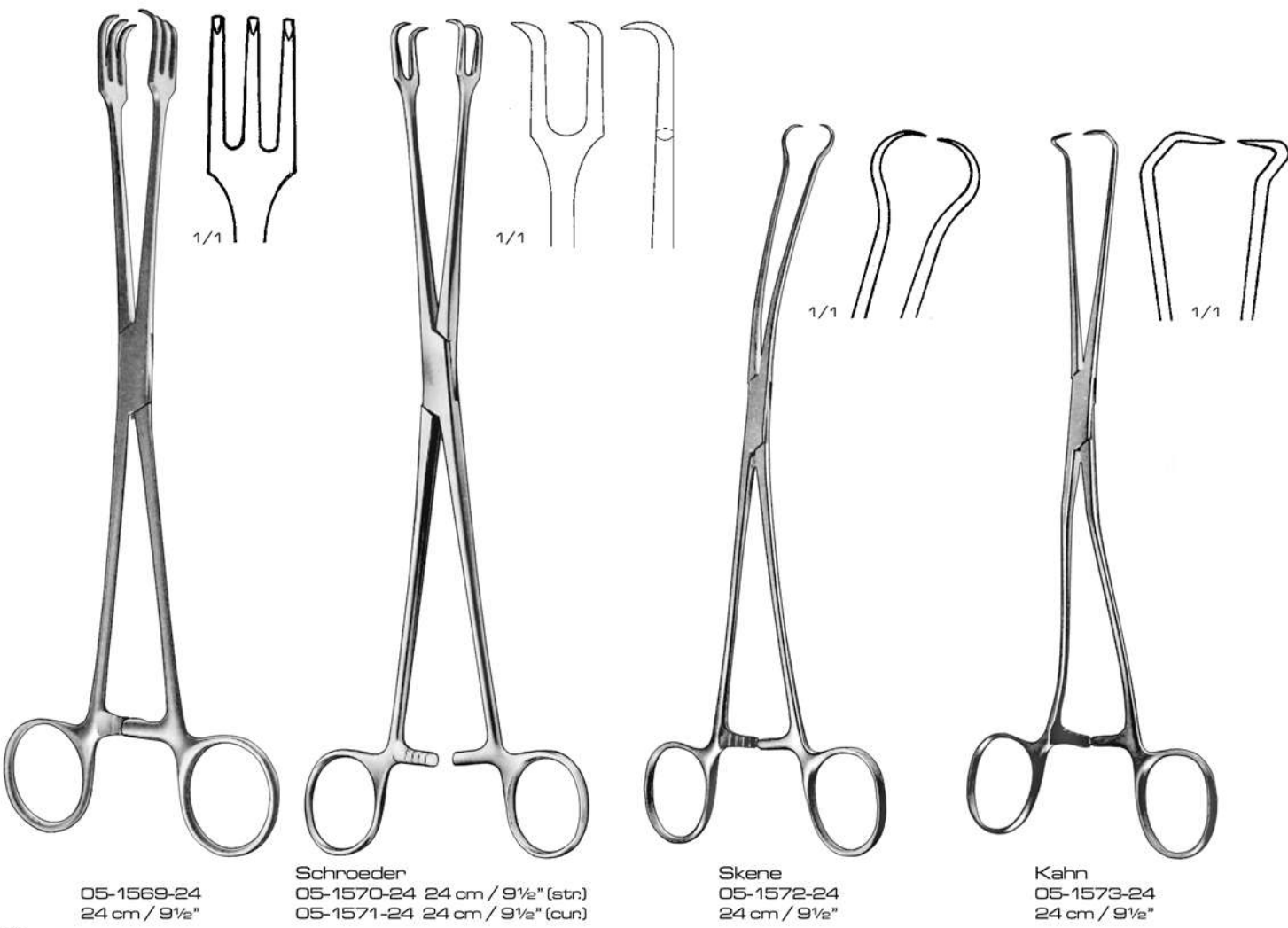
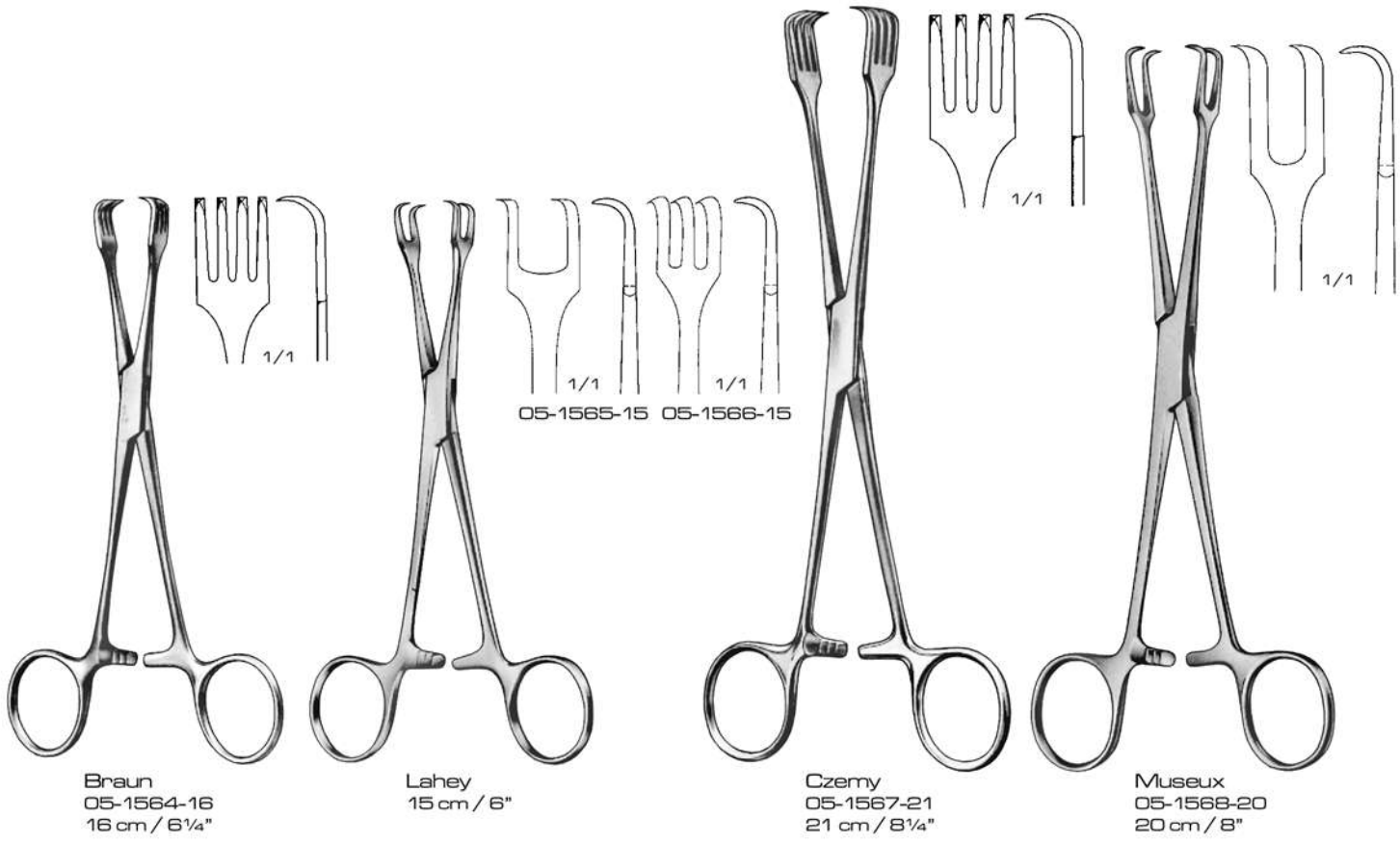

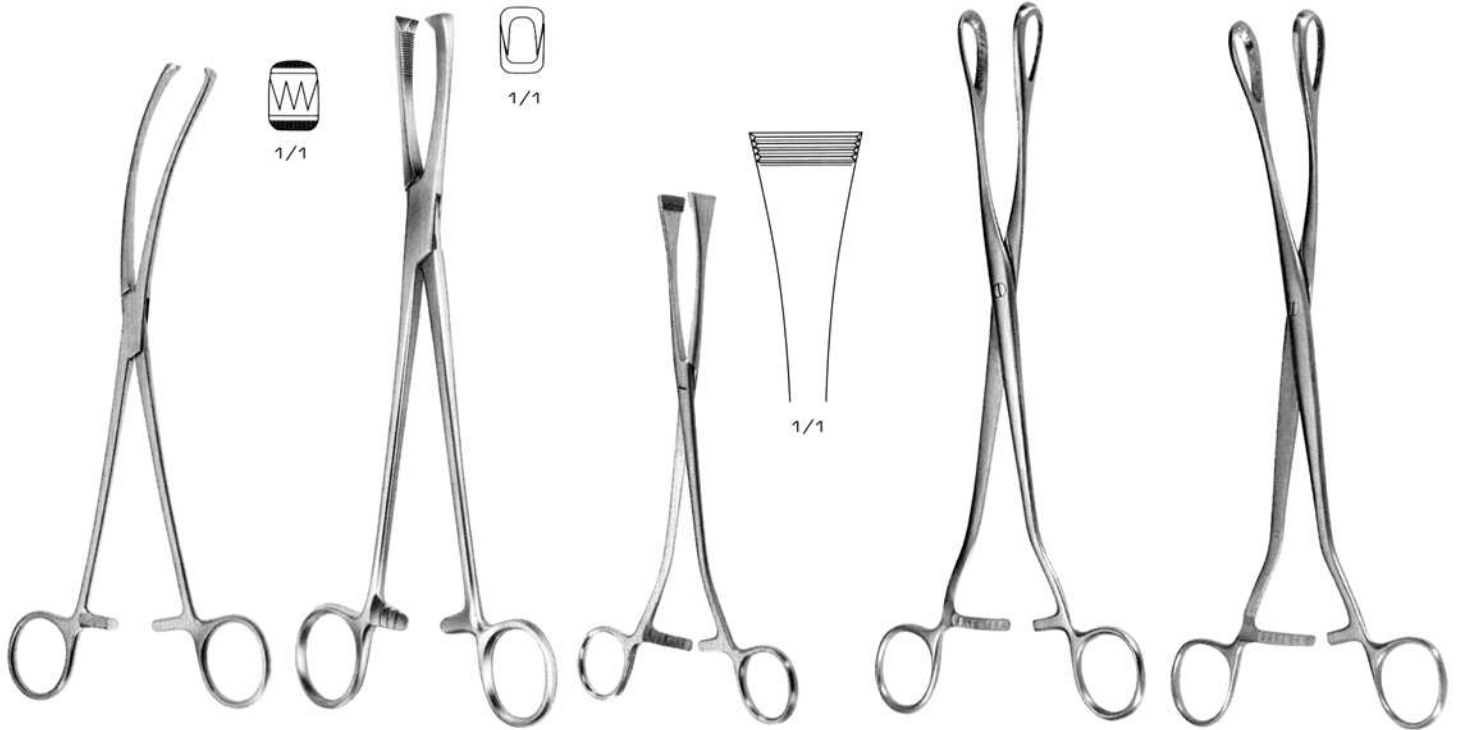

Teale
05-1574-23
23 cm / 9"

Jacobs
05-1575-21
21 cm / 8 1/4"

Green-Armytage
05-1576-21
21 cm / 8 1/4"

Saenger
05-1577-27
27 cm / 10 3/4"

Saenger
05-1578-27
27 cm / 10 3/4"

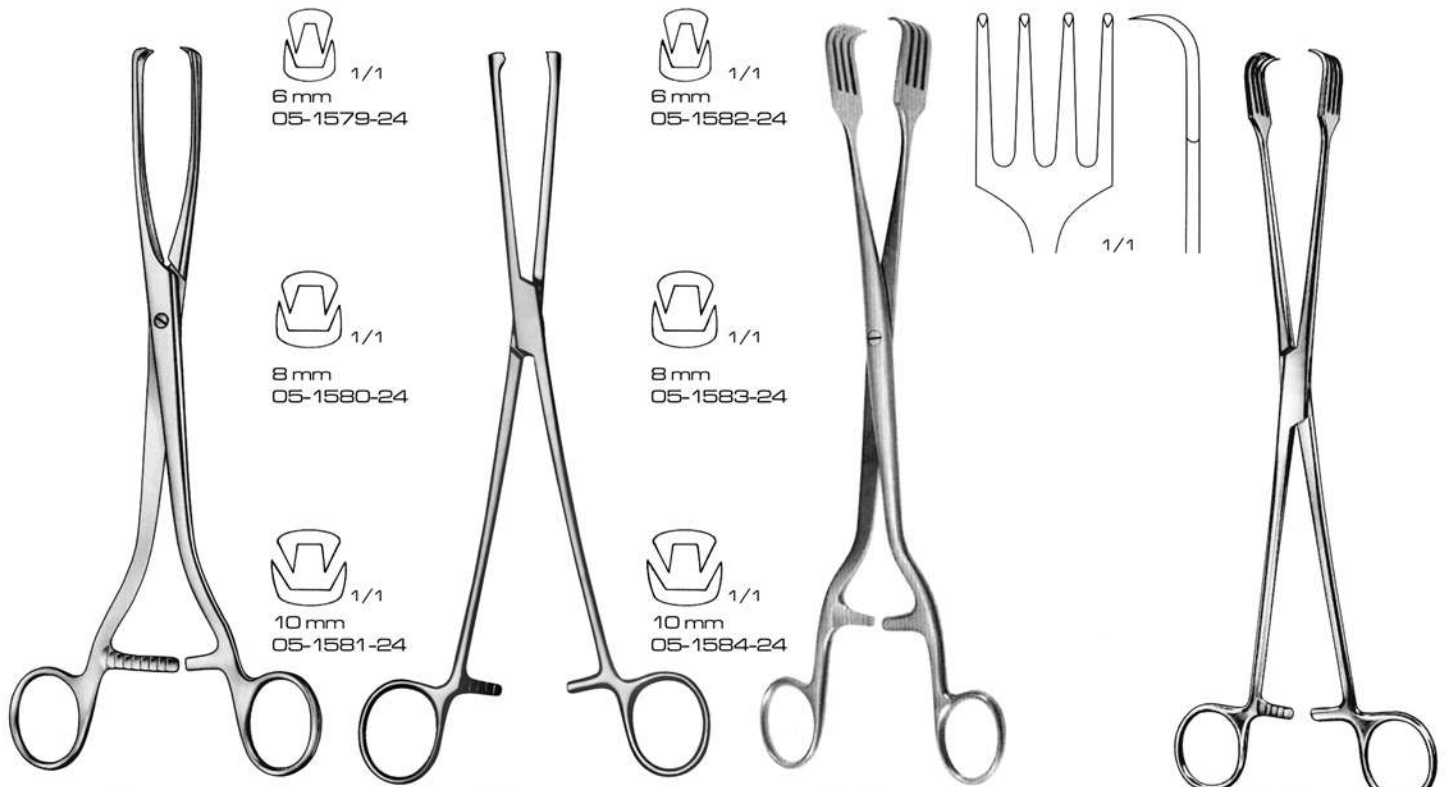

6 mm
05-1579-24

6 mm
05-1582-24

8 mm
05-1580-24

8 mm
05-1583-24

10 mm
05-1581-24

10 mm
05-1584-24

Museux
24 cm / 9 1/2"

Museux
24 cm / 9 1/2"

Pratt
05-1585-28
28 cm / 11"

Pratt
05-1586-26
26 cm / 10 1/4"

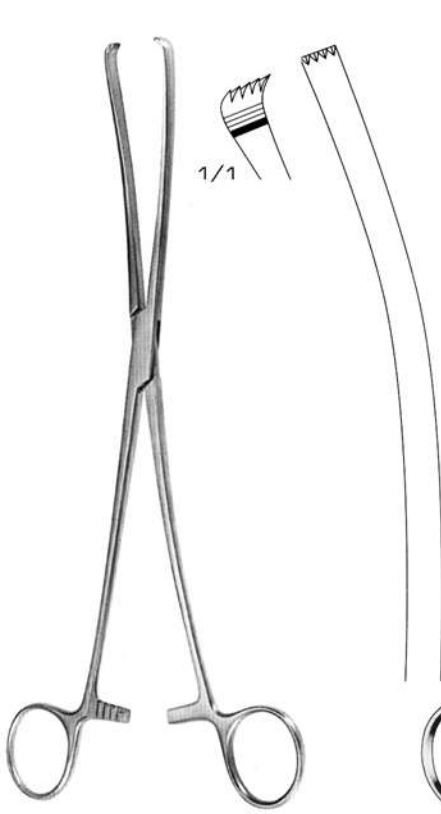

Iowa
05-1587-26
26 cm / 10 1/4"

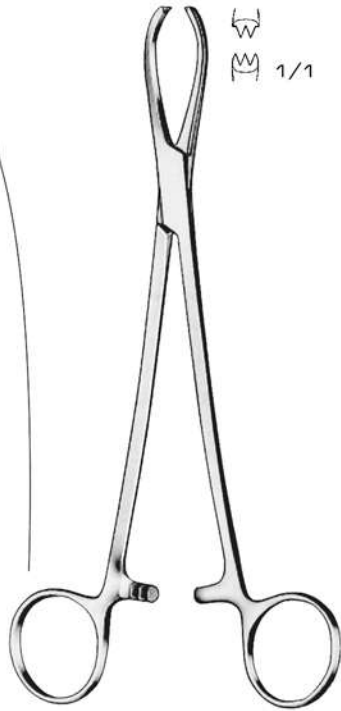

Littlewood
05-1588-185
18.5 cm / 7 1/4"

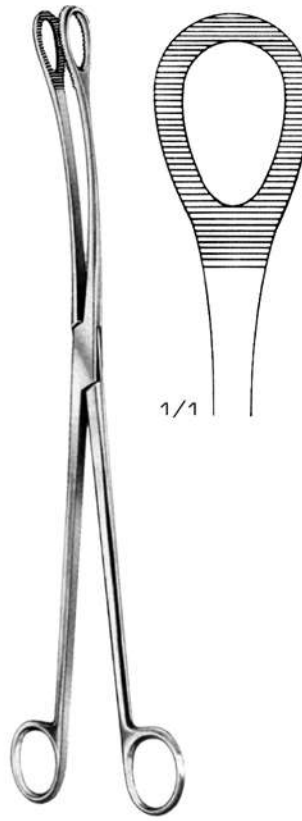

Kelly
05-1589-32
32 cm / 12 1/2"

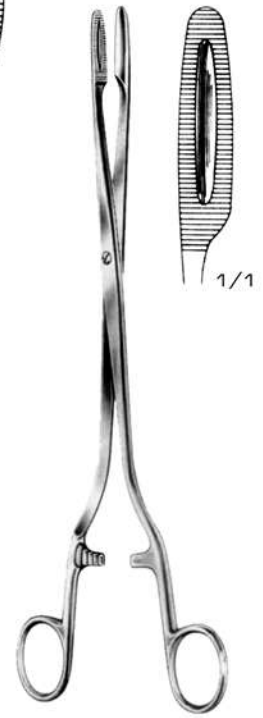

Sims-Maier
05-1590-28
28 cm / 11"

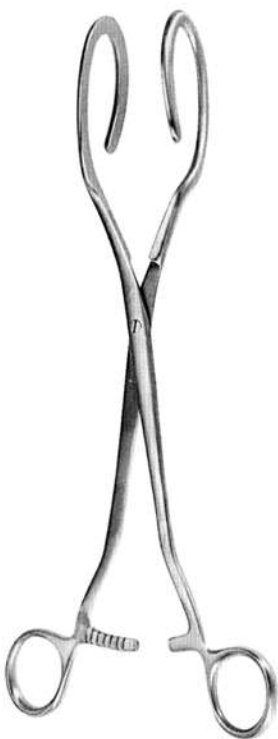

Dartigues
05-1591-27
27 cm / 10 3/4"

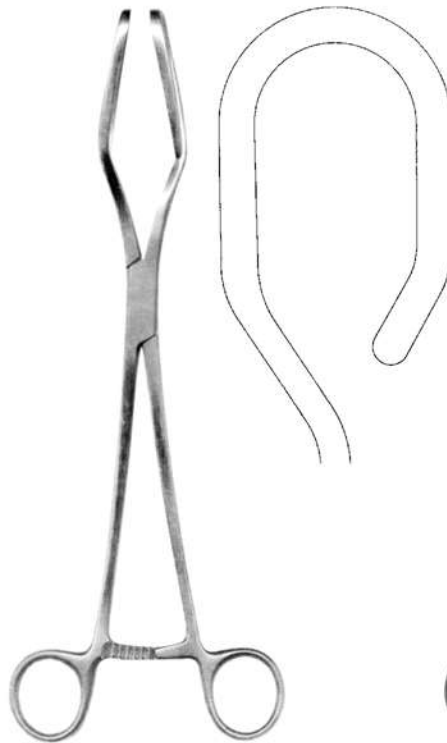

Dartigues
05-1592-27
27 cm / 10 3/4"

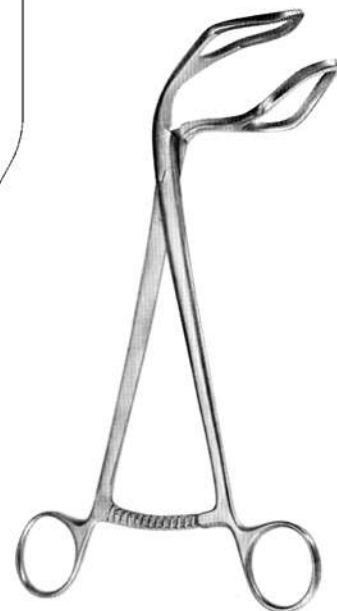

Sommer
05-1593-23
23 cm / 9"

Cardiovascular



OGE
ORTHOGENT
ENGINEERING

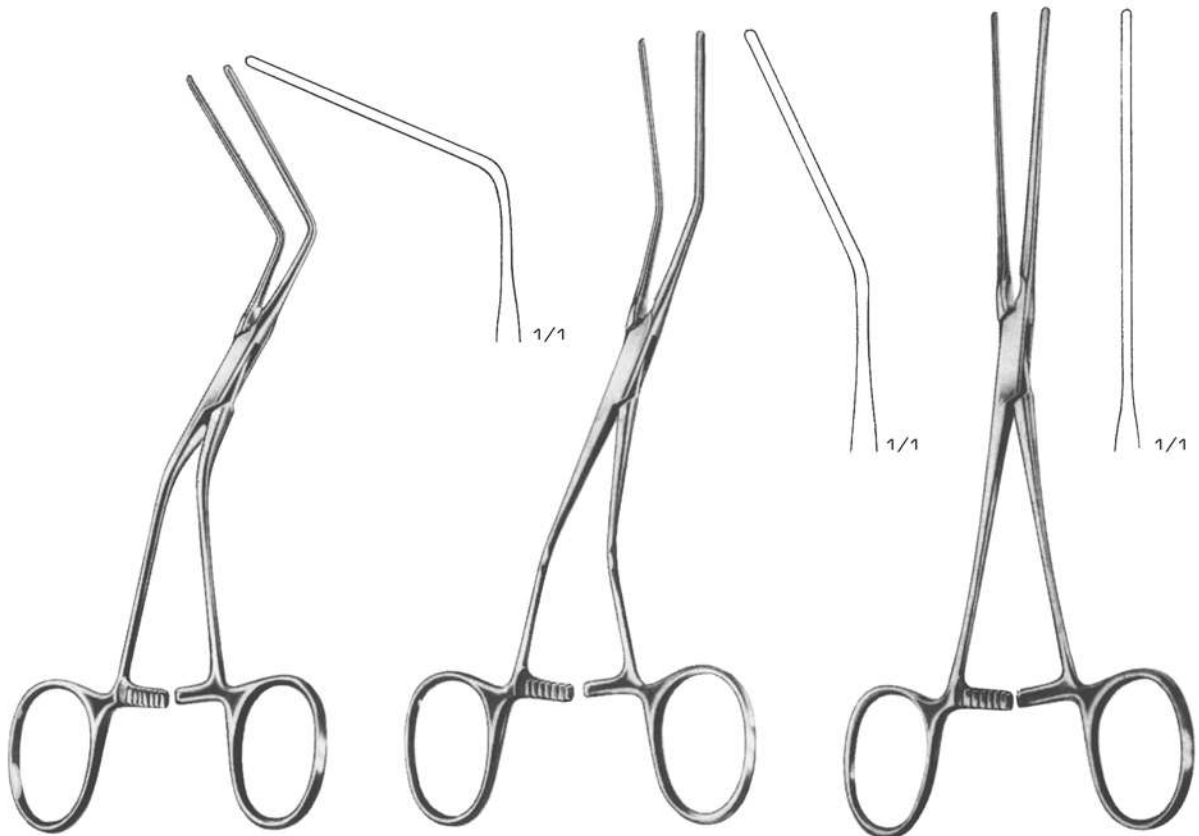

05-1594-15
15 cm / 6"

05-1595-16
16 cm / 6¼"

05-1596-165
16.5 cm / 6½"

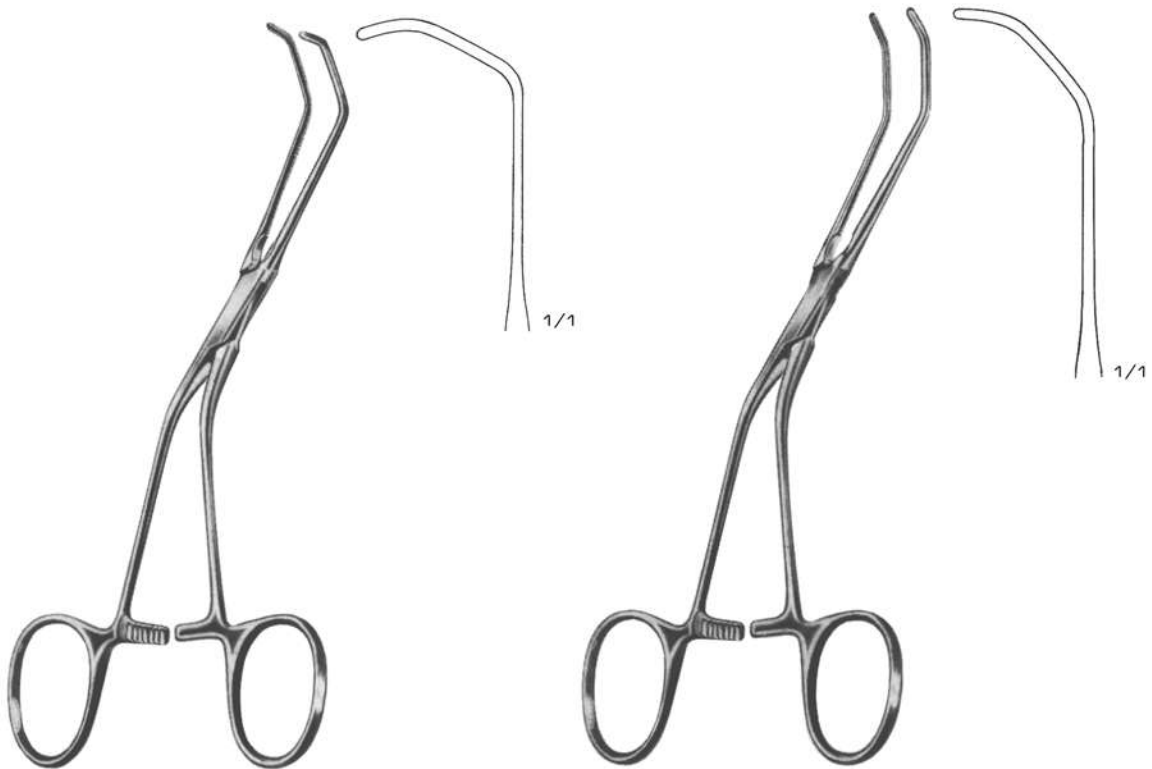

05-1597-15
15 cm / 6"

05-1598-155
15.5 cm / 6⅛"

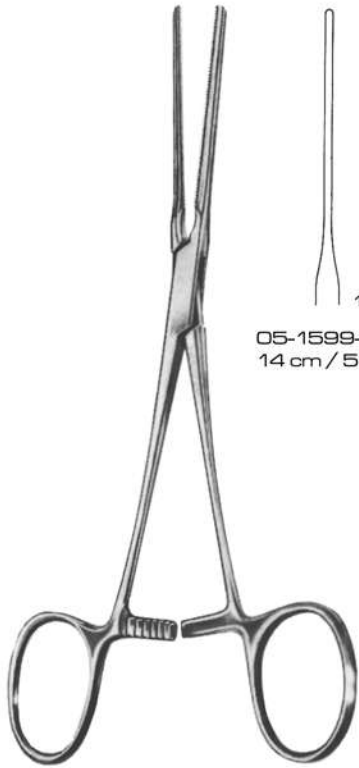

05-1599-14
14 cm / 5½"

05-1600-14
14 cm / 5½"

05-1601-135
13.5 cm / 5¼"

05-1602-13
13 cm / 5⅓"

05-1603-14
14 cm / 5½"

05-1604-125
12.5 cm / 5"

05-1605-125
12.5 cm / 5"

05-1606-13
13 cm / 5⅓"

05-1607-13
13 cm / 5⅓"

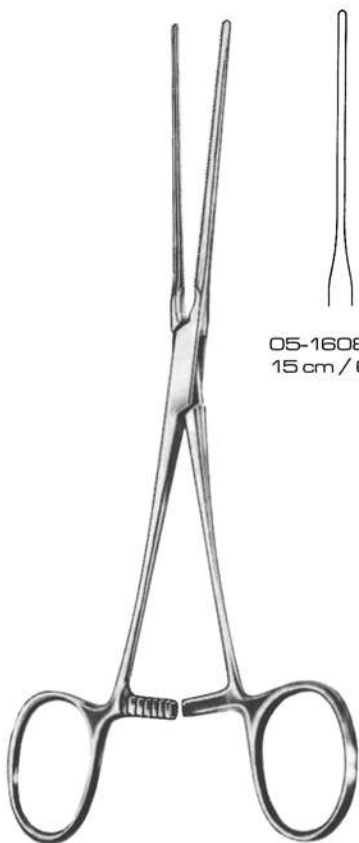

05-1608-15
15 cm / 6"

05-1609-15
15 cm / 6"

05-1610-145
14.5 cm / 5¾"

05-1611-14
14 cm / 5½"

05-1612-15
15 cm / 6"

05-1613-135
13.5 cm / 5¼"

05-1614-14
14 cm / 5½"

05-1615-15
15 cm / 6"

05-1616-145
14.5 cm / 5¾"

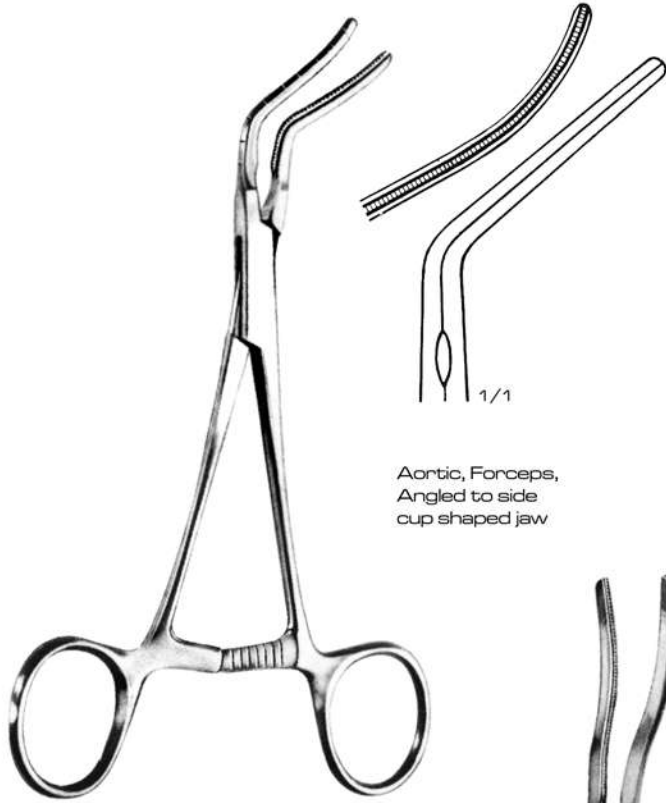

Aortic, Forceps,
Angled to side
cup shaped jaw

De-Bakey
05-1617-16
16 cm / 6¼"

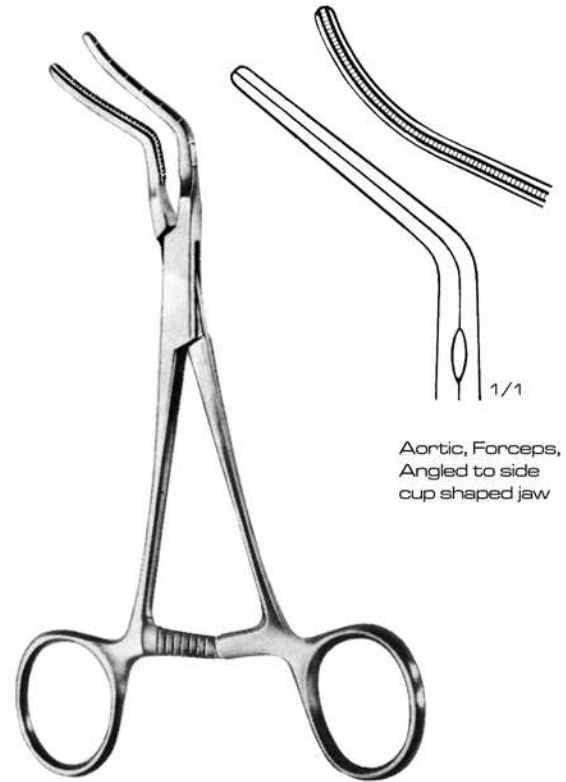

Aortic, Forceps,
Angled to side
cup shaped jaw

De-Bakey
05-1618-16
16 cm / 6¼"

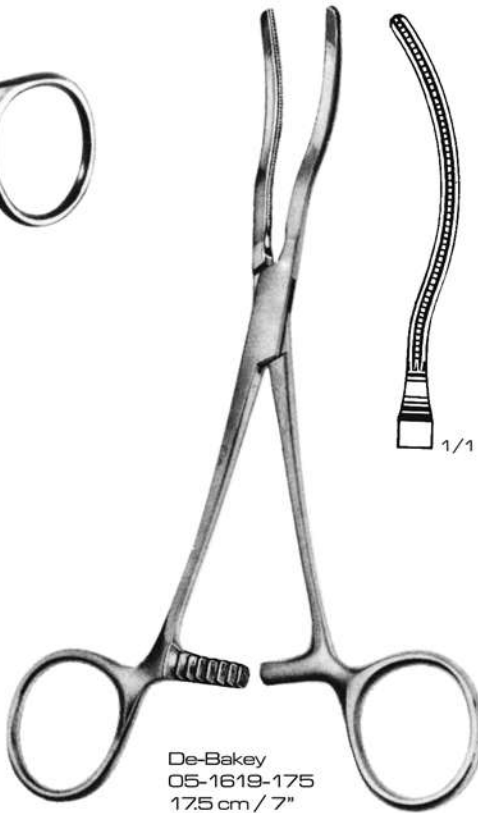

De-Bakey
05-1619-175
17.5 cm / 7"

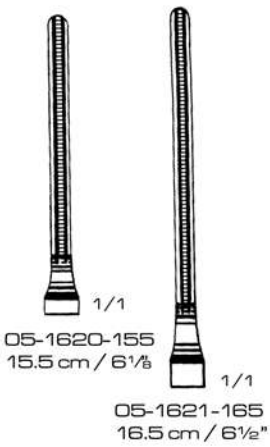

05-1620-155
15.5 cm / 6⅛"

05-1621-165
16.5 cm / 6½"

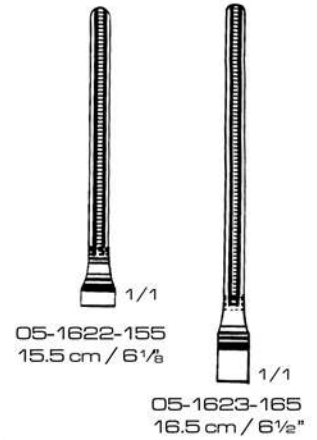

05-1622-155
15.5 cm / 6⅛"

05-1623-165
16.5 cm / 6½"

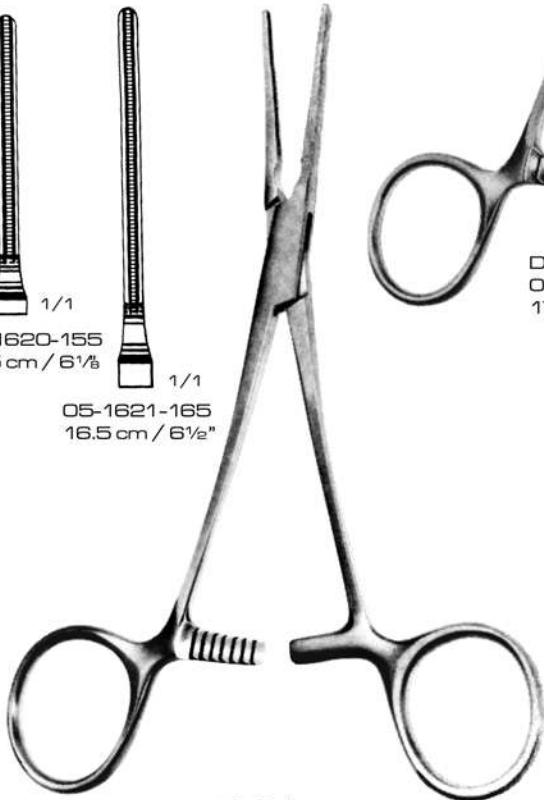

De-Bakey



De-Bakey

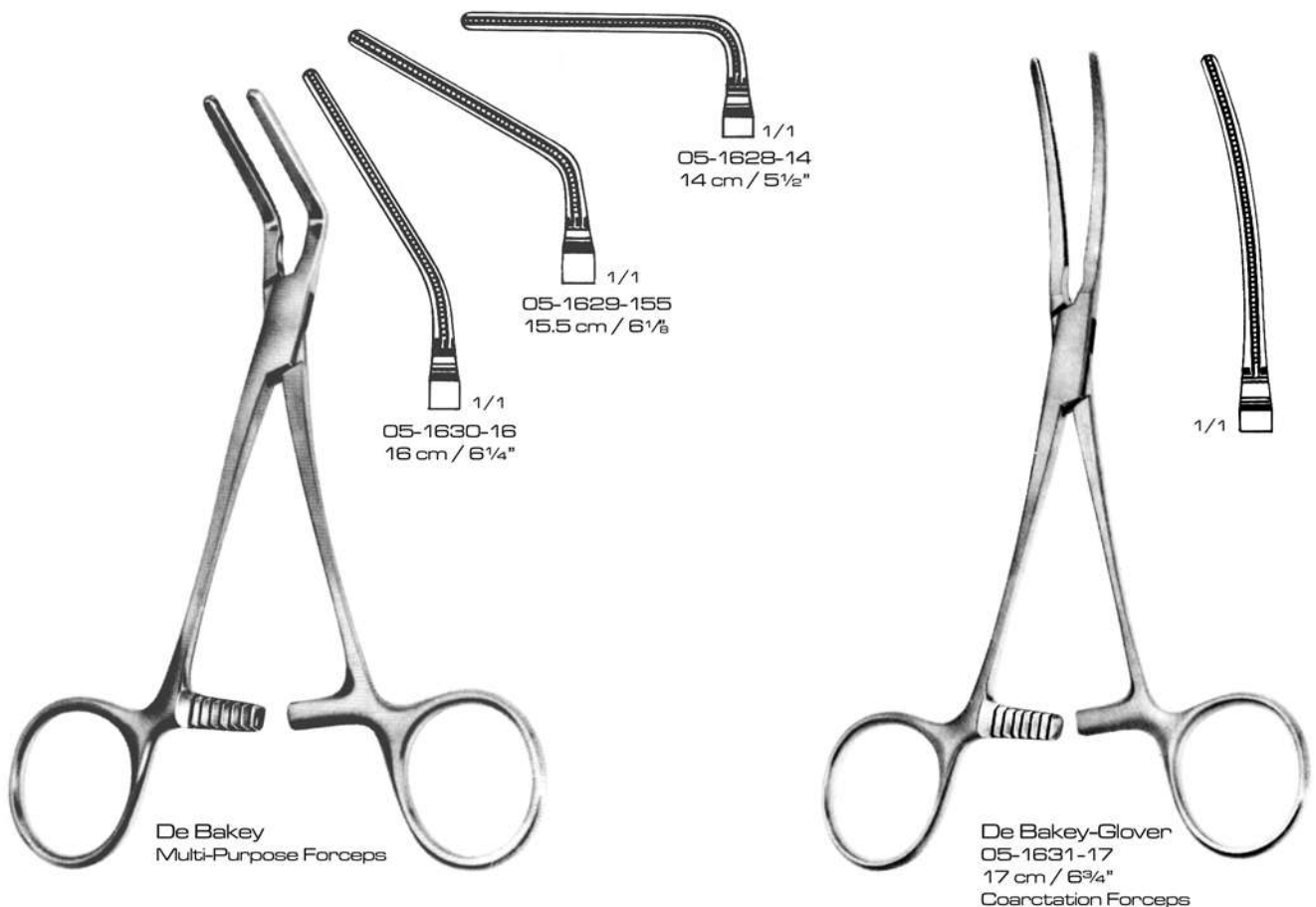
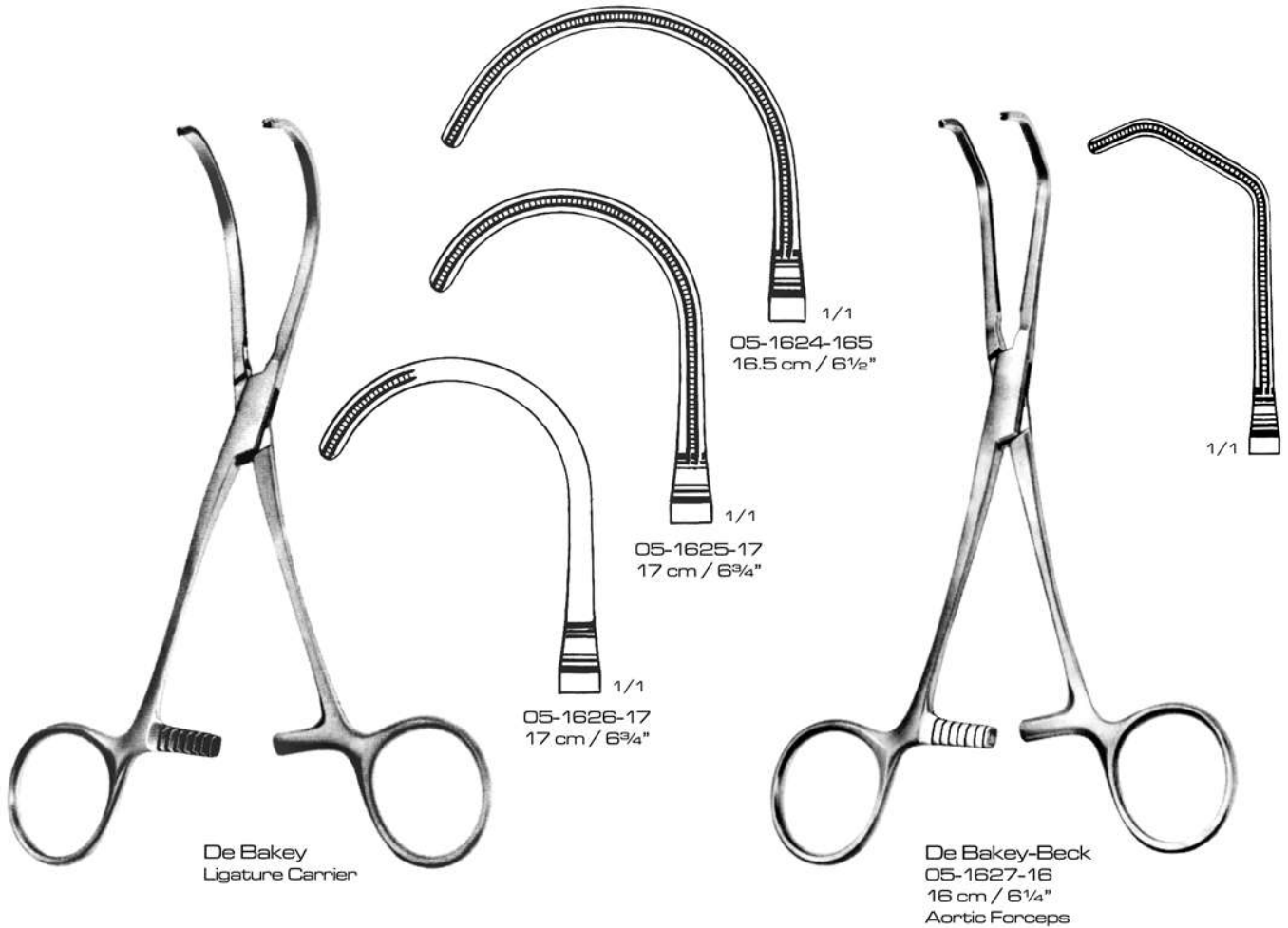



De Bakey-Derra
Anastomosis Forceps

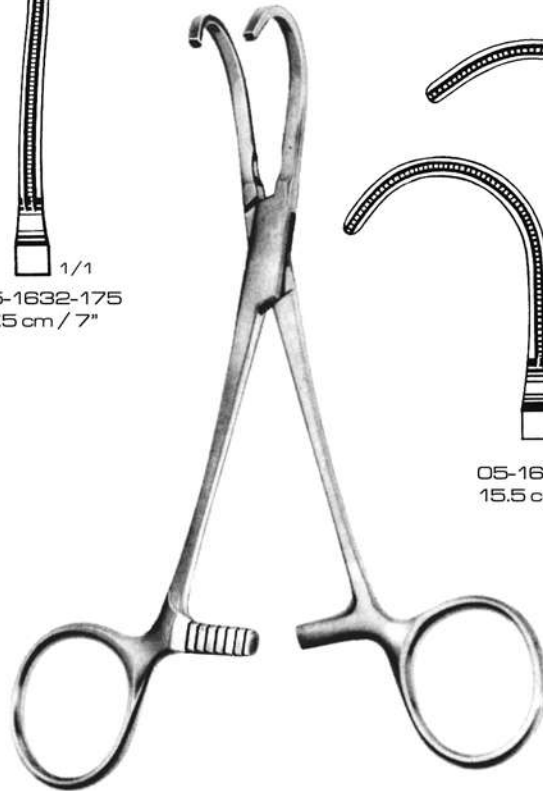
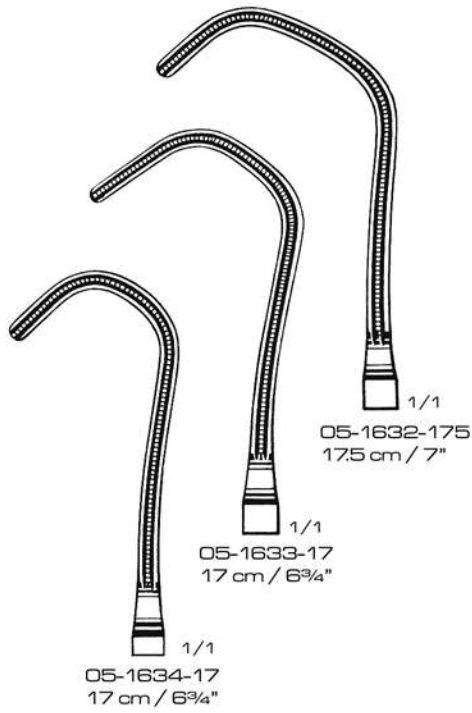

De Bakey Beck

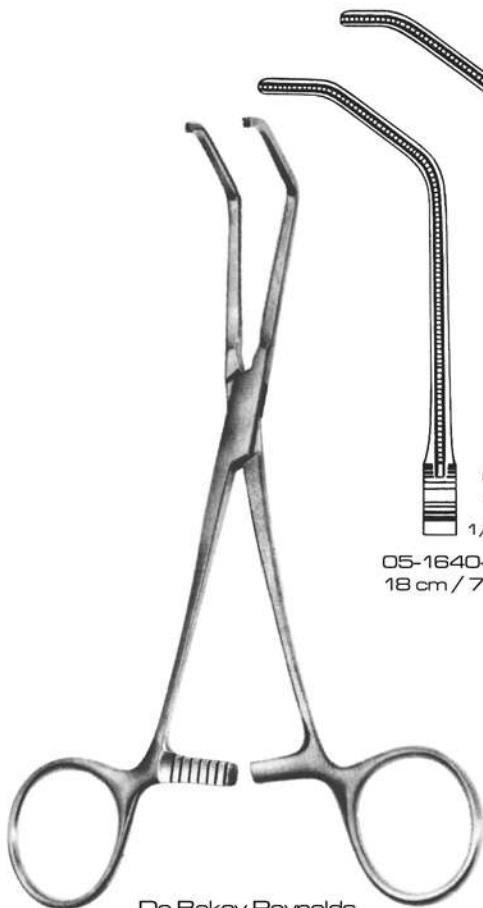
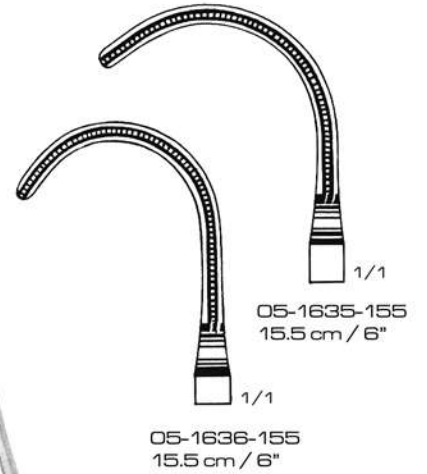

De Bakey Reynolds
Anastomosis Forceps

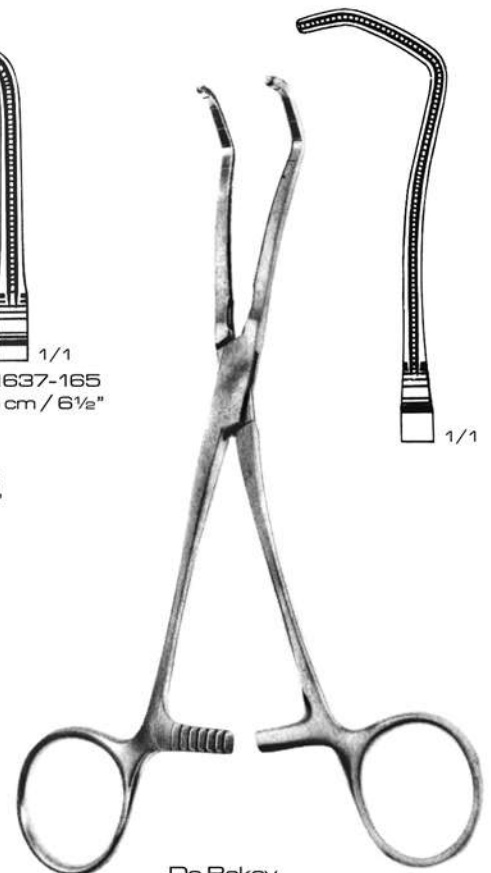
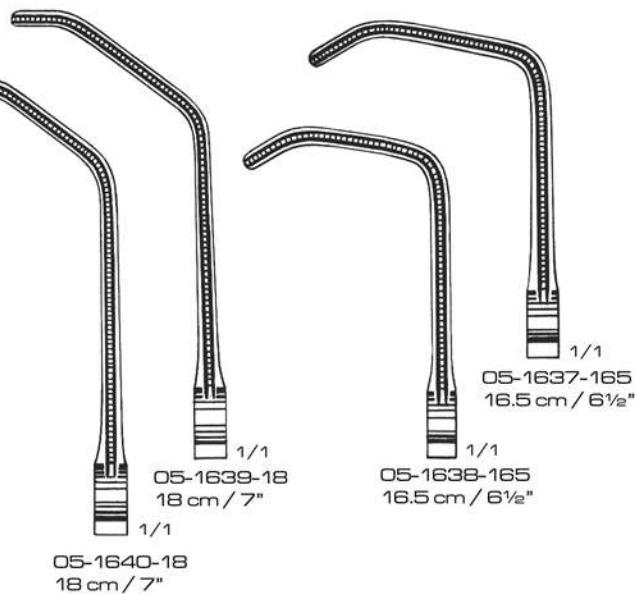

De Bakey
05-1641-175
17.5 cm / 7"
Anastomosis Forceps

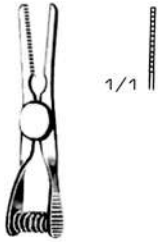

05-1642-3
3 cm / 1 1/8"

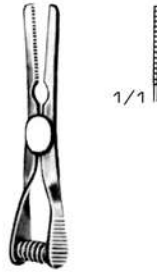

05-1643-35
3.5 cm / 1 3/8"

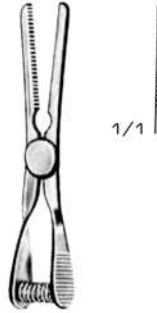

05-1644-4
4 cm / 1 5/8"

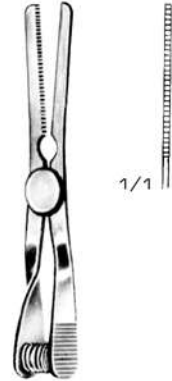

05-1645-5
5 cm / 2"

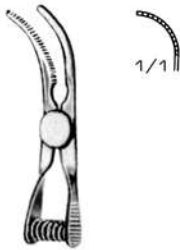

05-1646-3
3 cm / 1 1/8"



05-1647-35
3.5 cm / 1 3/8"

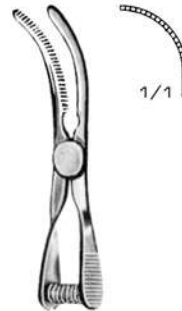

05-1648-4
4 cm / 1 5/8"

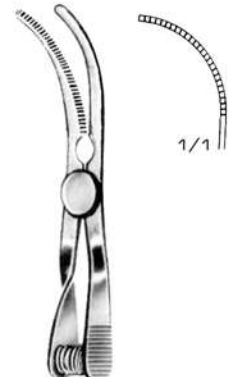

05-1649-5
5 cm / 2"

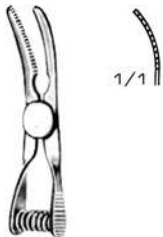

05-1650-3
3 cm / 1 1/8"

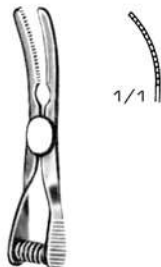

05-1651-35
3.5 cm / 1 3/8"

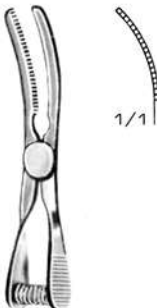

05-1652-4
4 cm / 1 5/8"

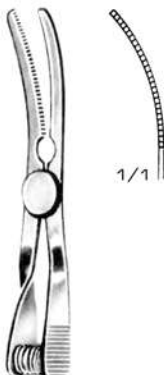

05-1653-5
5 cm / 2"

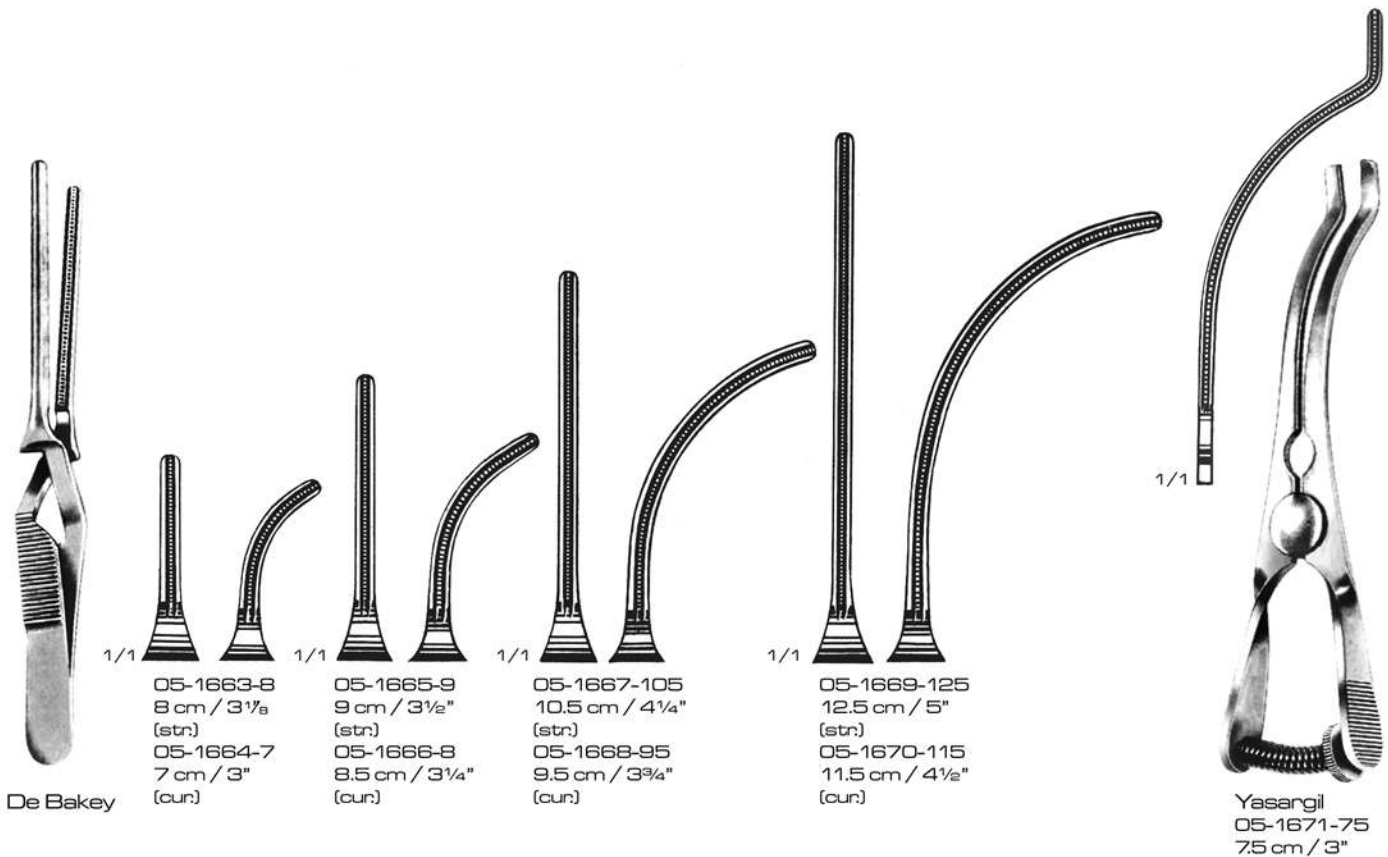
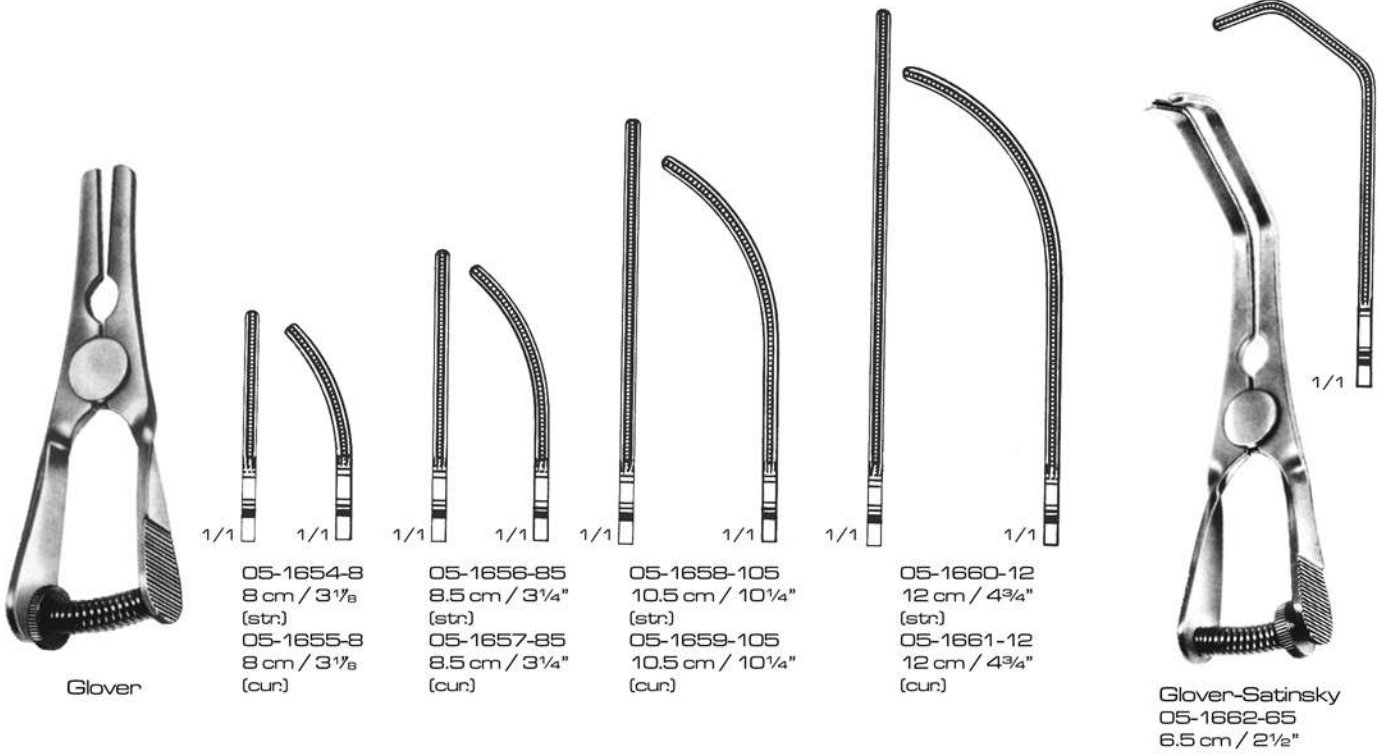

NON-TRAUMATIC VASCULAR CLAMPS

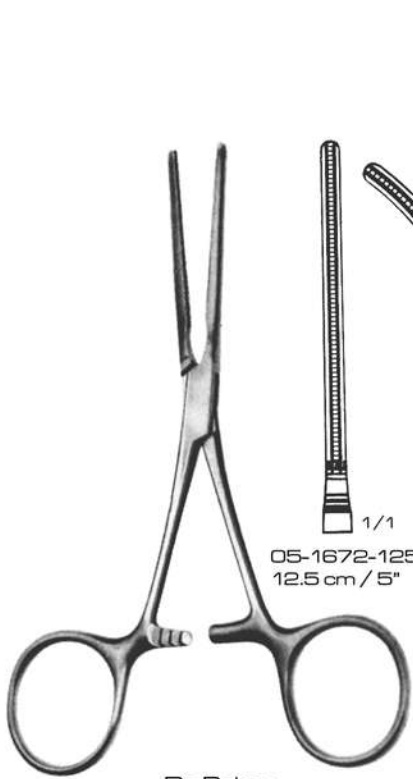

De Bakey

05-1672-125 12.5 cm / 5"
05-1673-125 12.5 cm / 5"

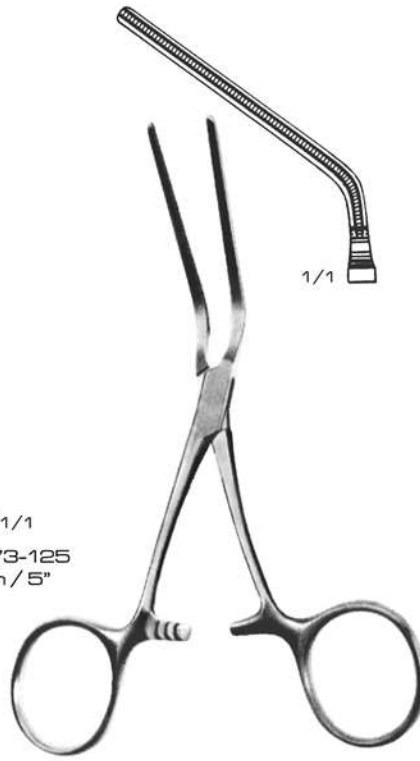

De Bakey
05-1674-125
12.5 cm / 5"



De Bakey
05-1675-10
10 cm / 4"

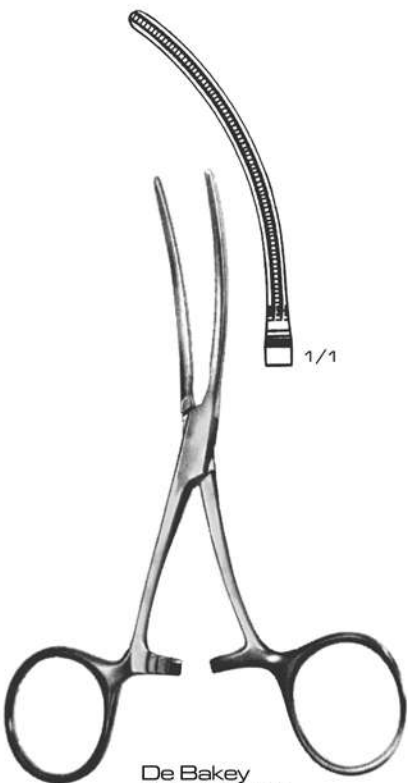

De Bakey
05-1676-125
12.5 cm / 5"

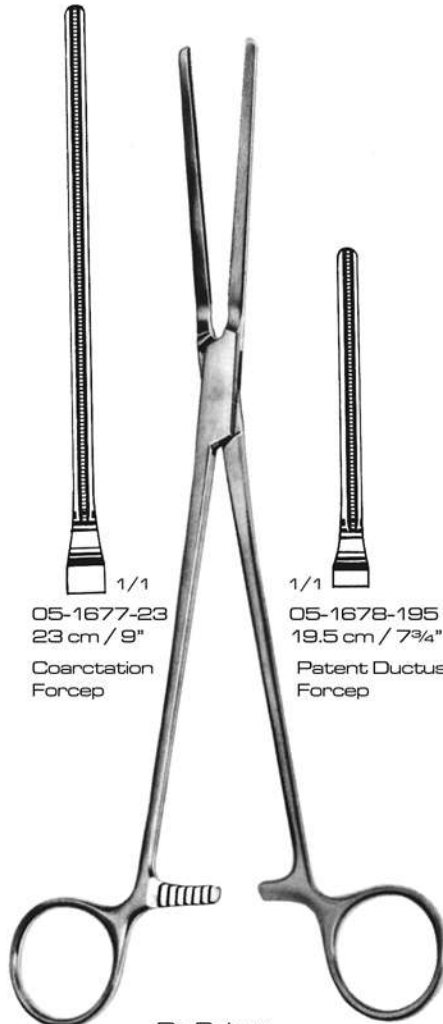

De Bakey

05-1677-23 23 cm / 9"
Coarctation
Forcep

05-1678-195 19.5 cm / 7 3/4"
Patent Ductus
Forcep

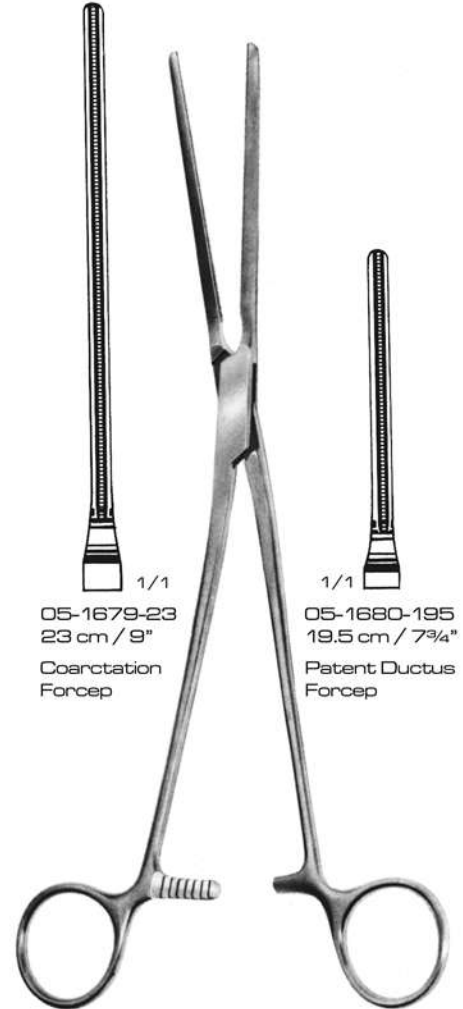

De Bakey

05-1679-23 23 cm / 9"
Coarctation
Forcep

05-1680-195 19.5 cm / 7 3/4"
Patent Ductus
Forcep

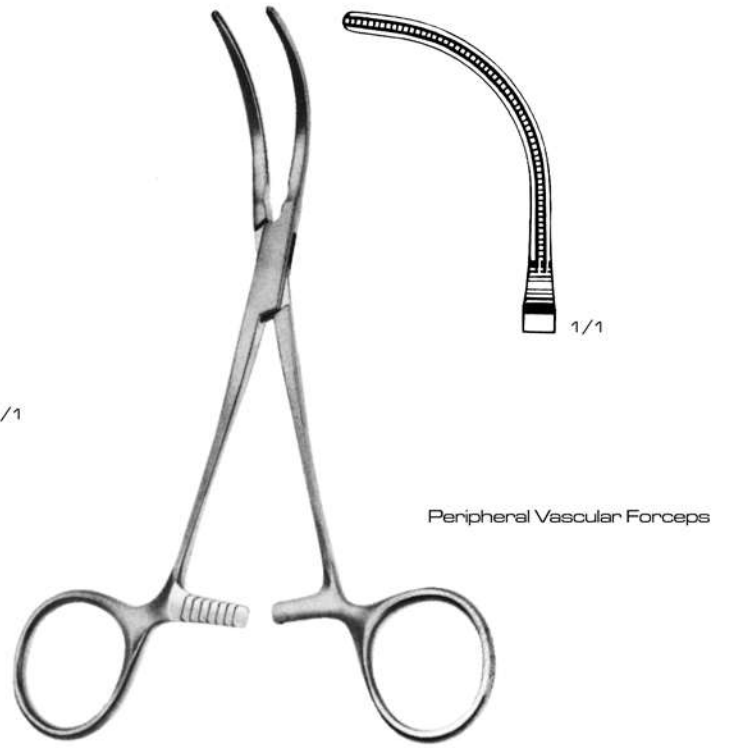
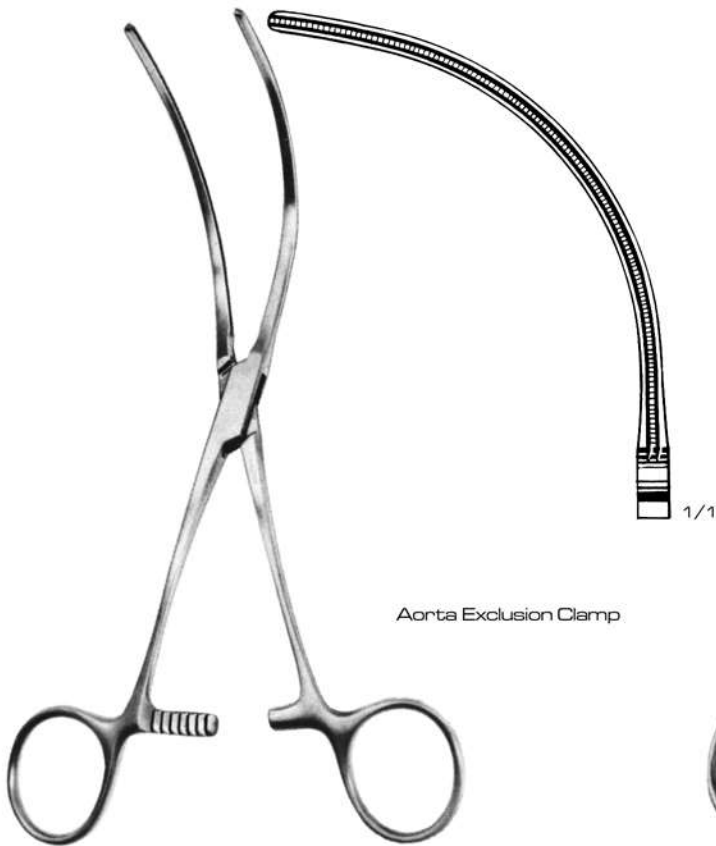
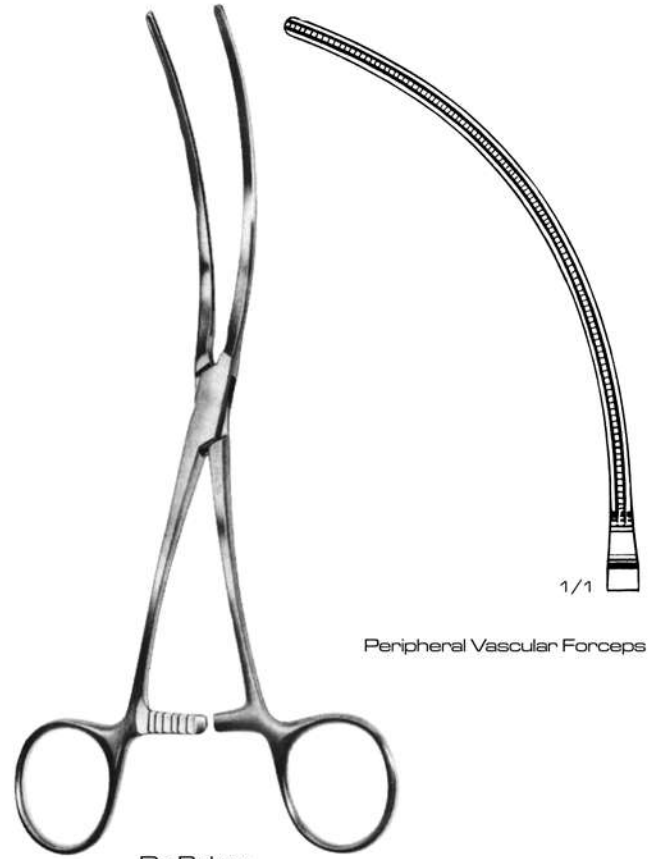
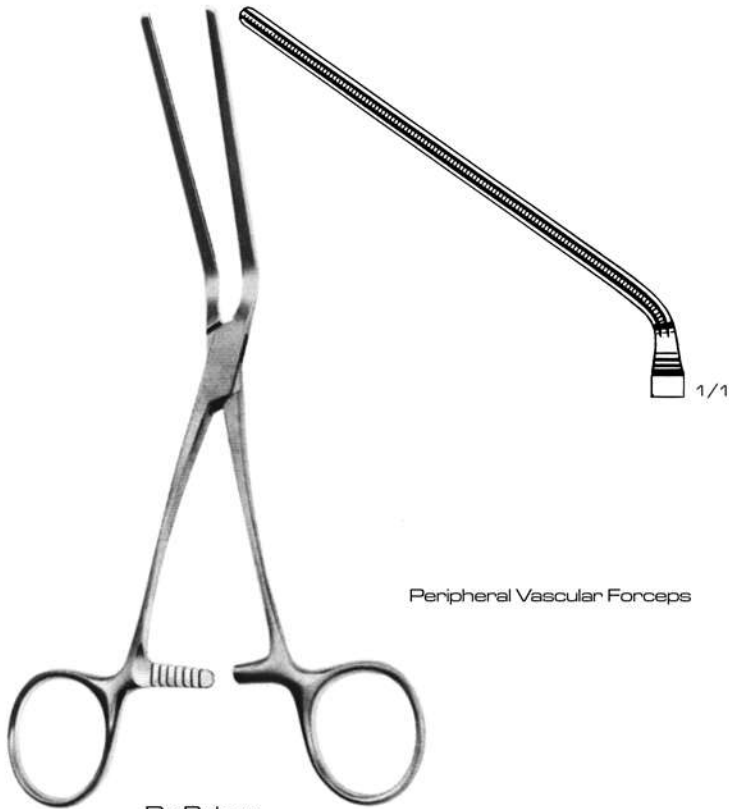

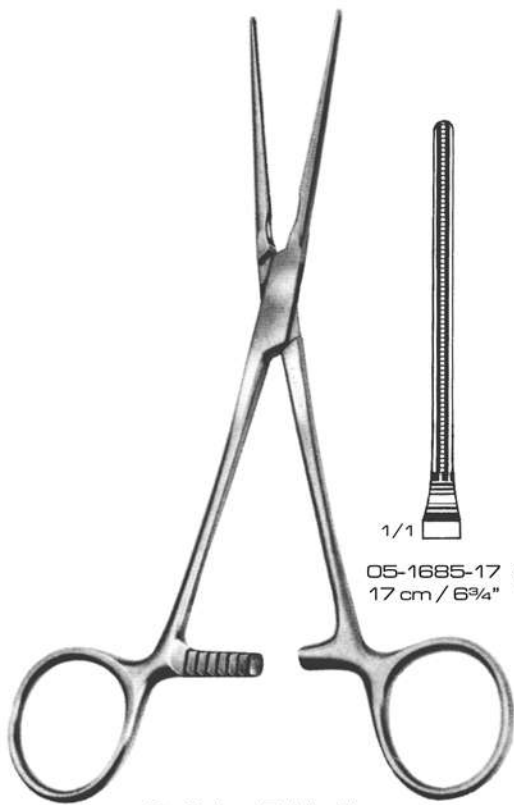

De Bakey-Bainbridge

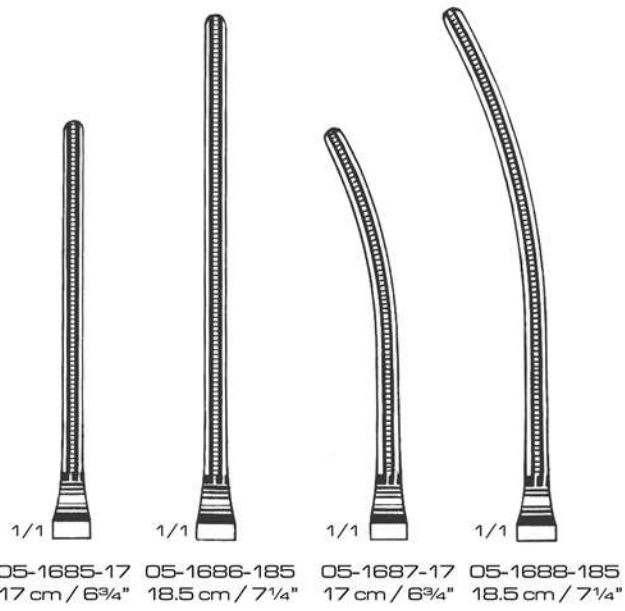

05-1685-17 17 cm / 6³/₄"
 05-1686-185 18.5 cm / 7¹/₄"
 05-1687-17 17 cm / 6³/₄"
 05-1688-185 18.5 cm / 7¹/₄"

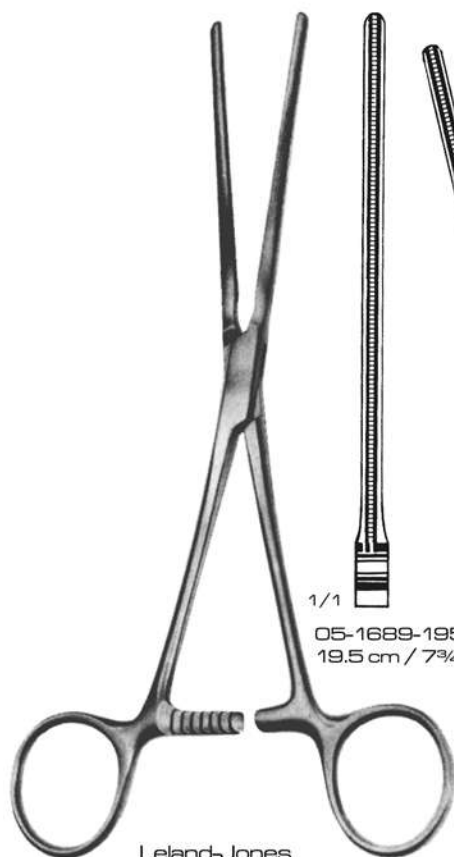

Leland-Jones

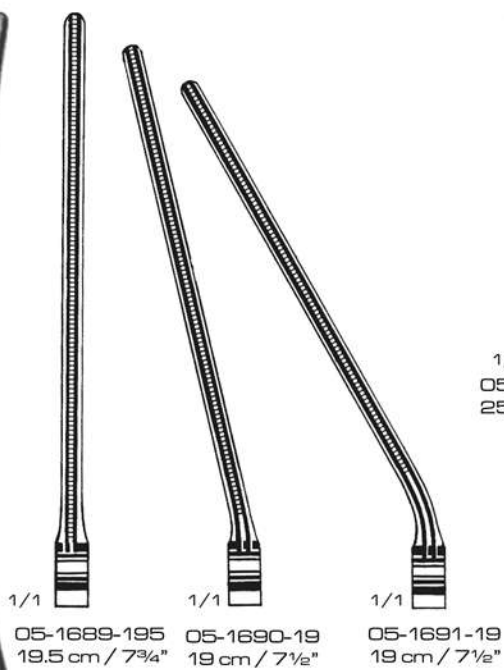

05-1689-195 19.5 cm / 7³/₄"
 05-1690-19 19 cm / 7¹/₂"
 05-1691-19 19 cm / 7¹/₂"

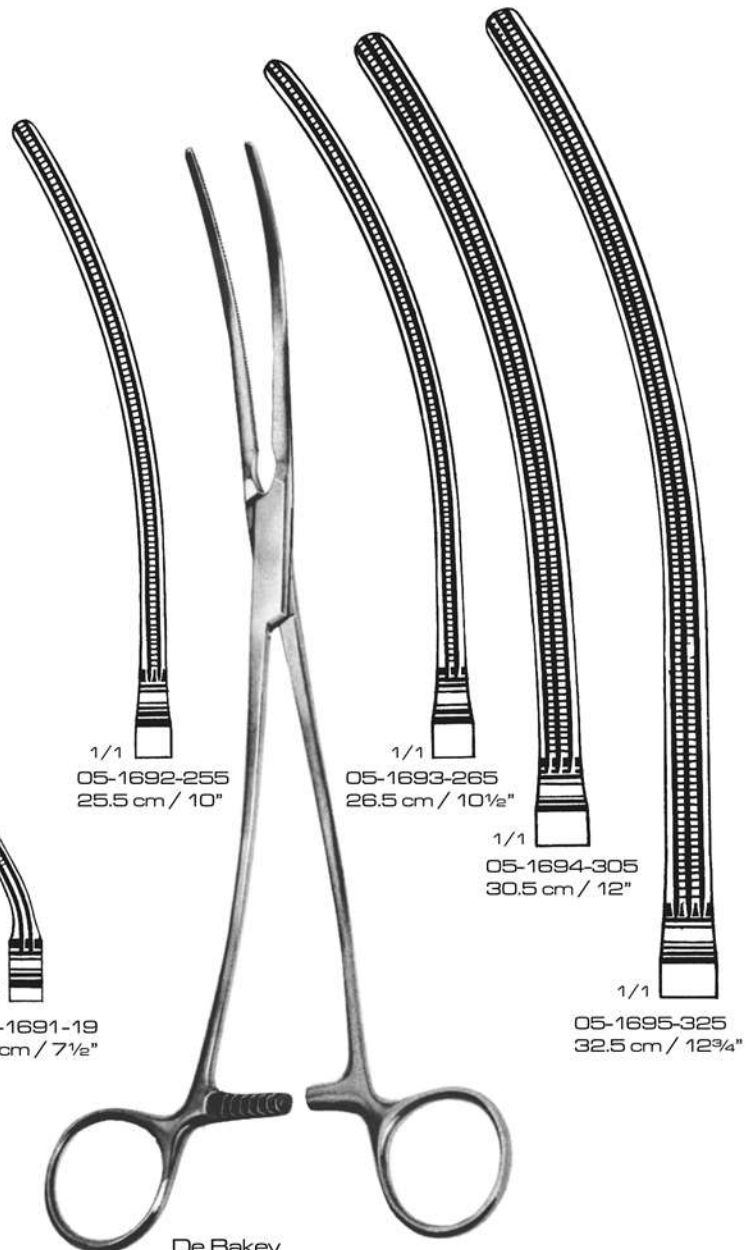

De Bakey
Aortic Aneurysm Clamps

05-1692-255 25.5 cm / 10"
 05-1693-265 26.5 cm / 10¹/₂"
 05-1694-305 30.5 cm / 12"
 05-1695-325 32.5 cm / 12³/₄"

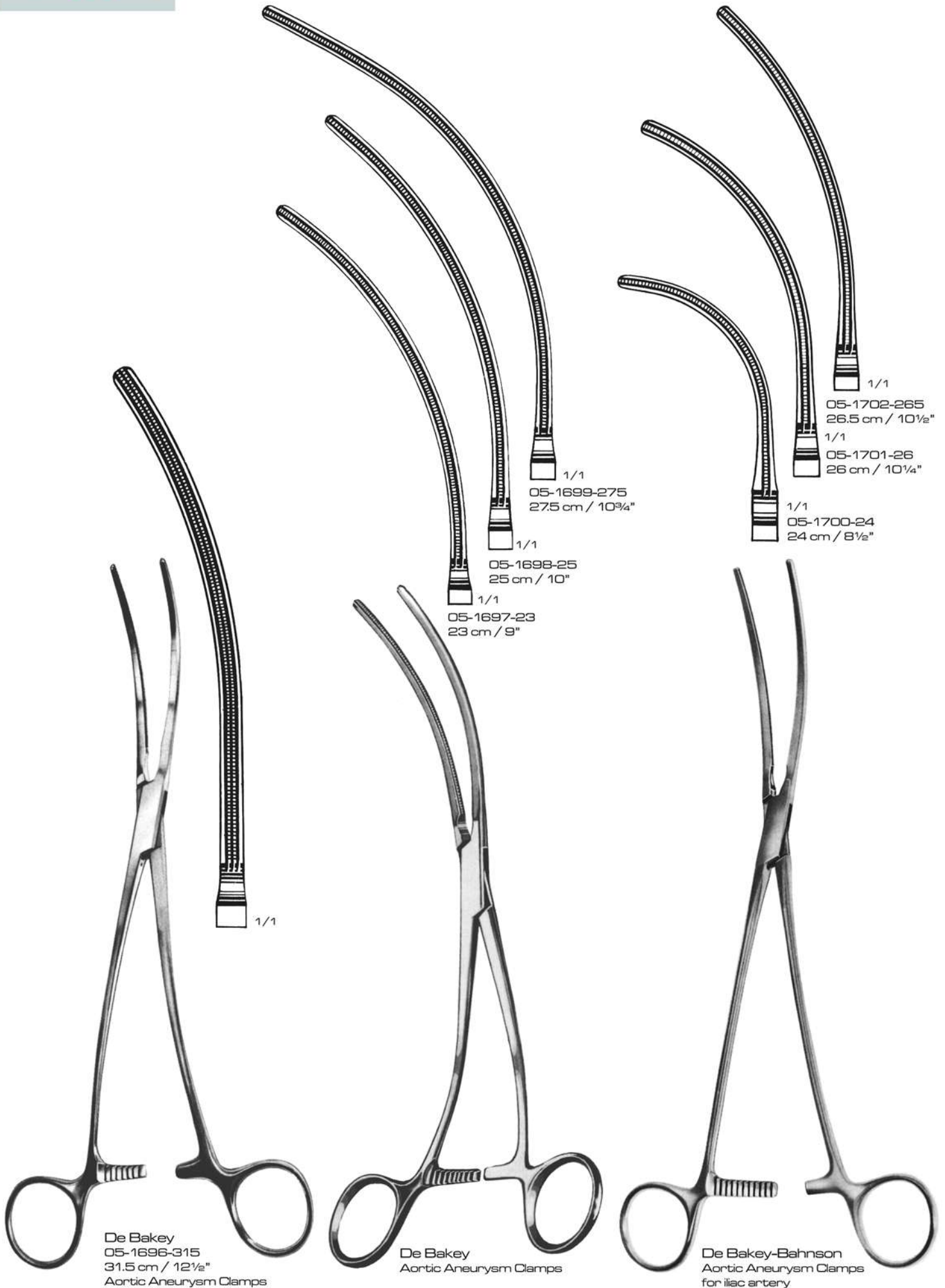

NON-TRAUMATIC VASCULAR CLAMPS



De Bakey
Aortic Forceps, angled up,
cup shaped jaw

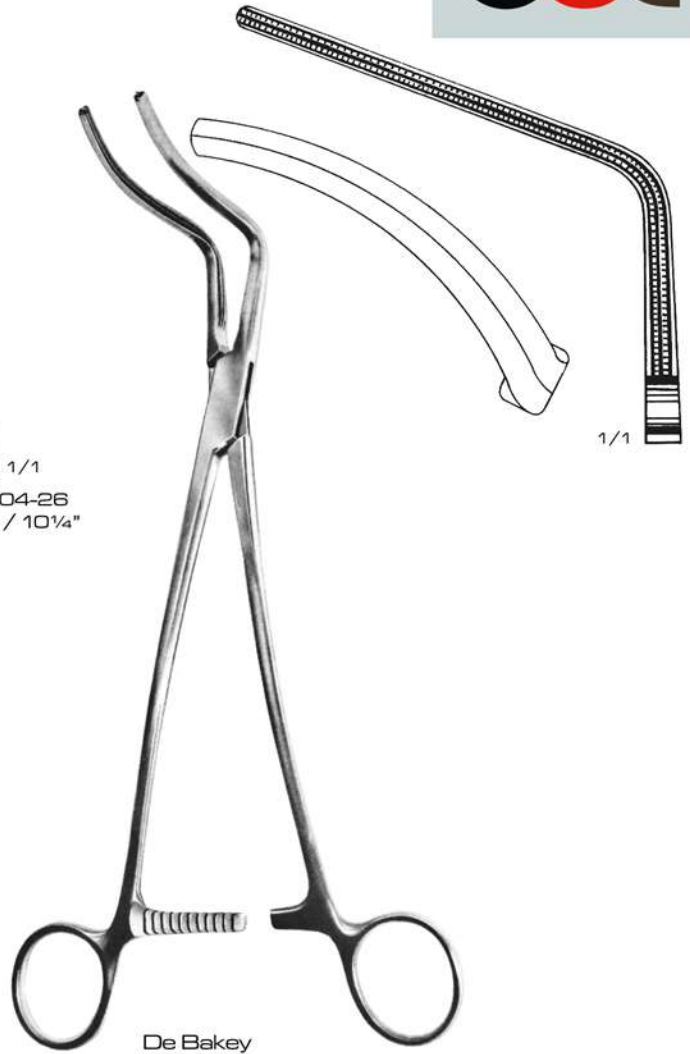
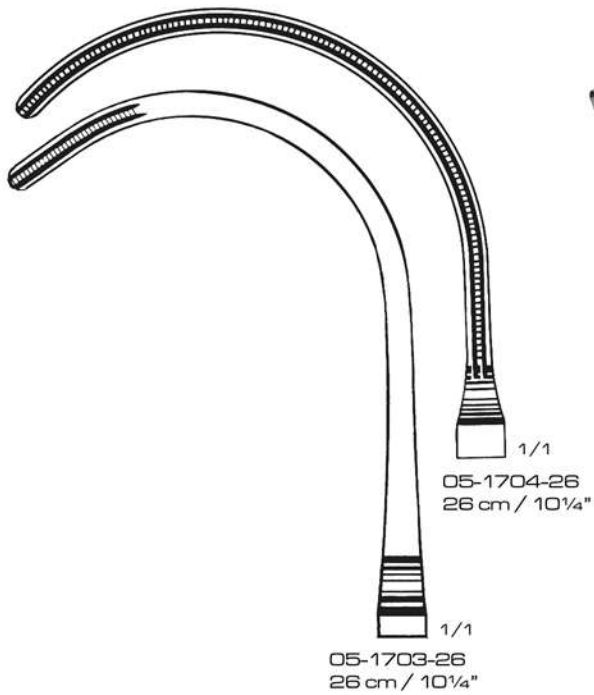

De Bakey
05-1705-265
26.5 cm / 10 1/2"
Aortic Forceps, angled up,
cup shaped jaw



Wylie
05-1706-23
23 cm / 9"

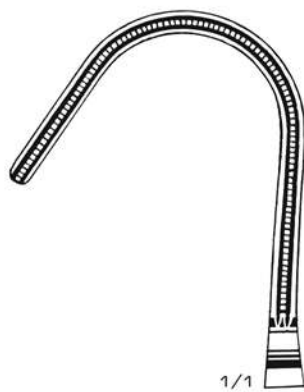

Wylie
05-1707-23
23 cm / 9"

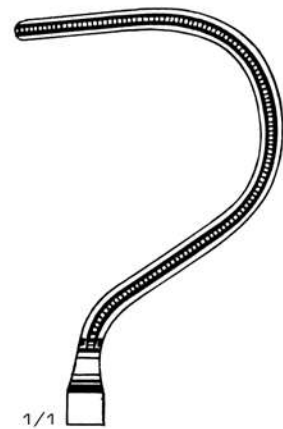

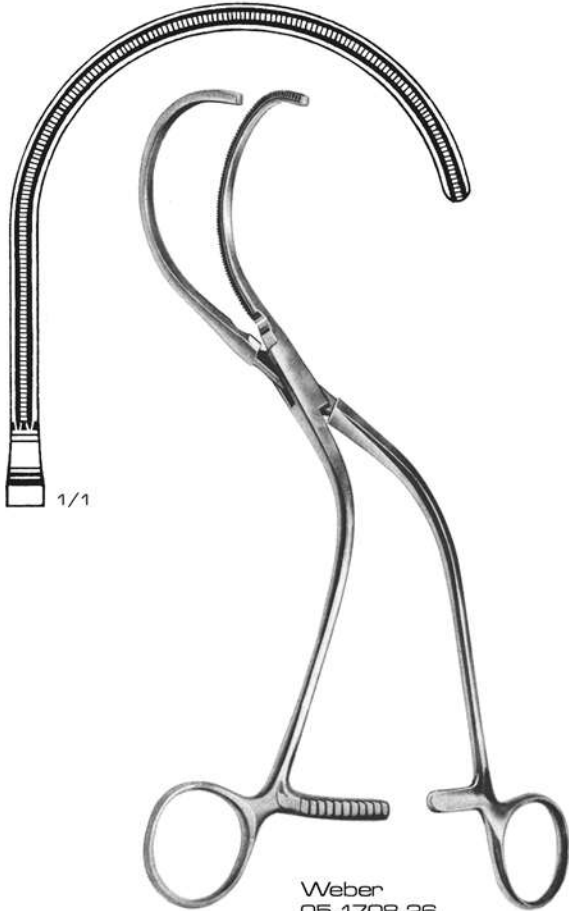

1/1

Weber
05-1708-26
26 cm / 10¹/₄"
left
Aortic Forceps

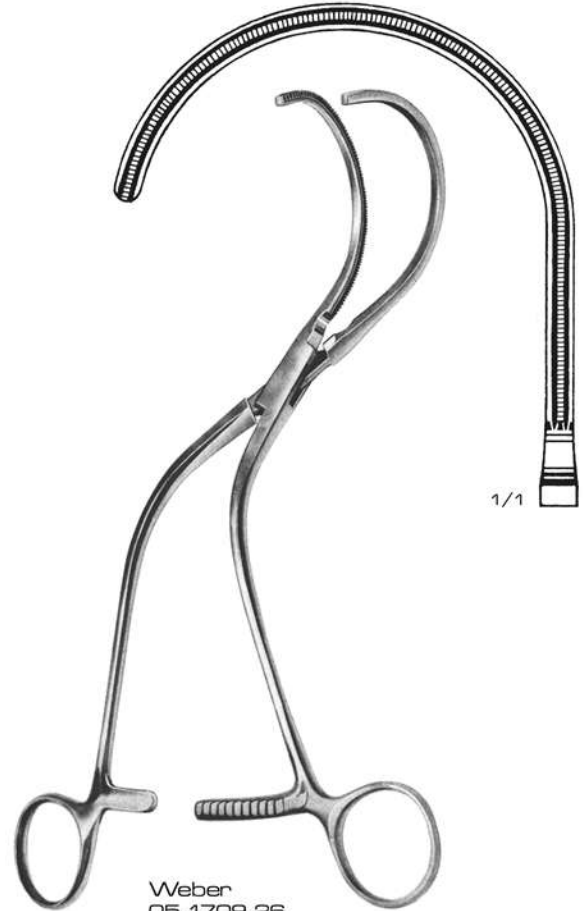

1/1

Weber
05-1709-26
26 cm / 10¹/₄"
right
Aortic Forceps



De-Bakey

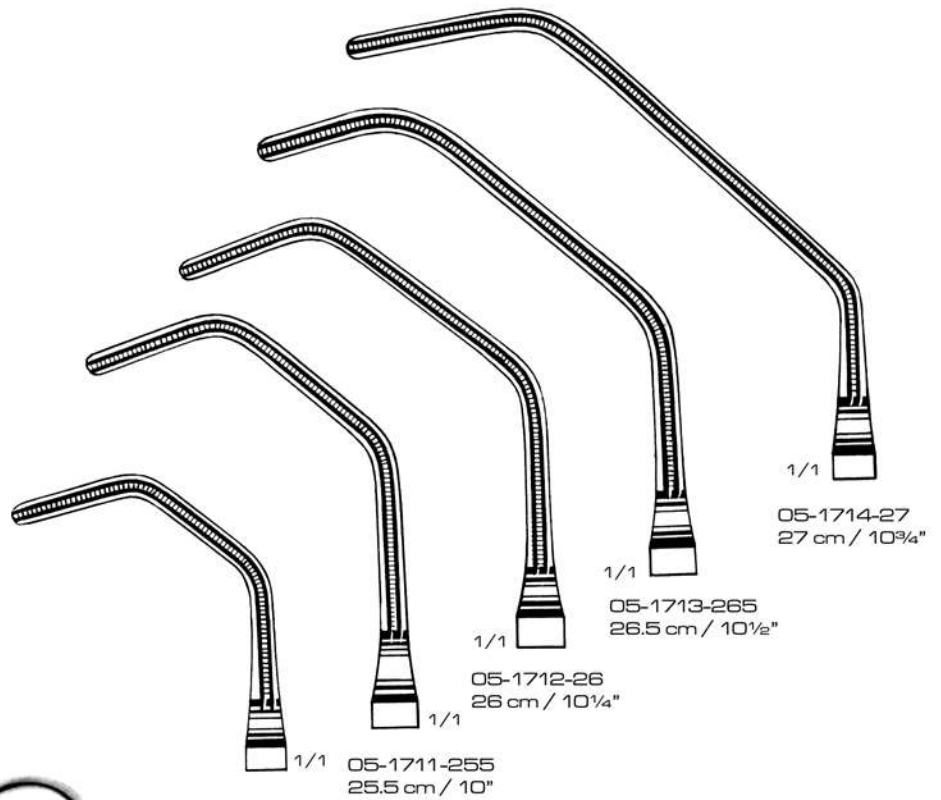

1/1

05-1714-27
27 cm / 10³/₄"

1/1

05-1713-265
26.5 cm / 10¹/₂"

1/1

05-1712-26
26 cm / 10¹/₄"

1/1

05-1711-255
25.5 cm / 10"

1/1

05-1710-195
19.5 cm / 7³/₄"

NON-TRAUMATIC VASCULAR CLAMPS

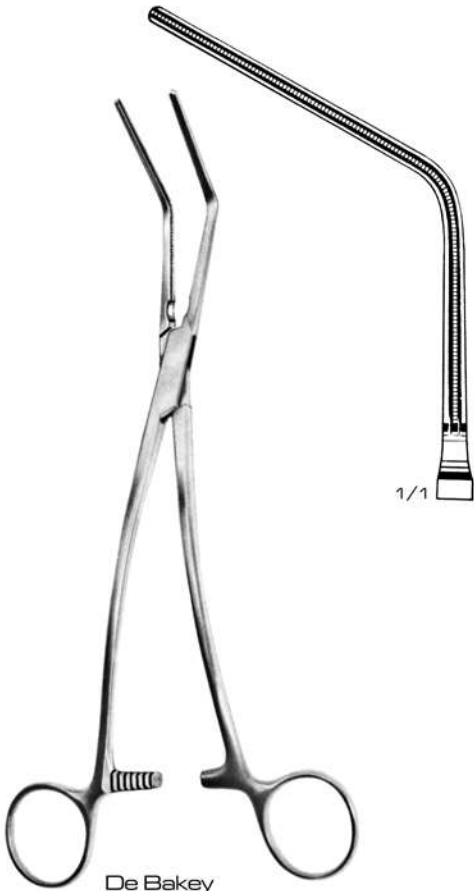

De Bakey
05-1715-25
25 cm / 9³/₄"
Multi-Purpose Forceps,
angled 60°

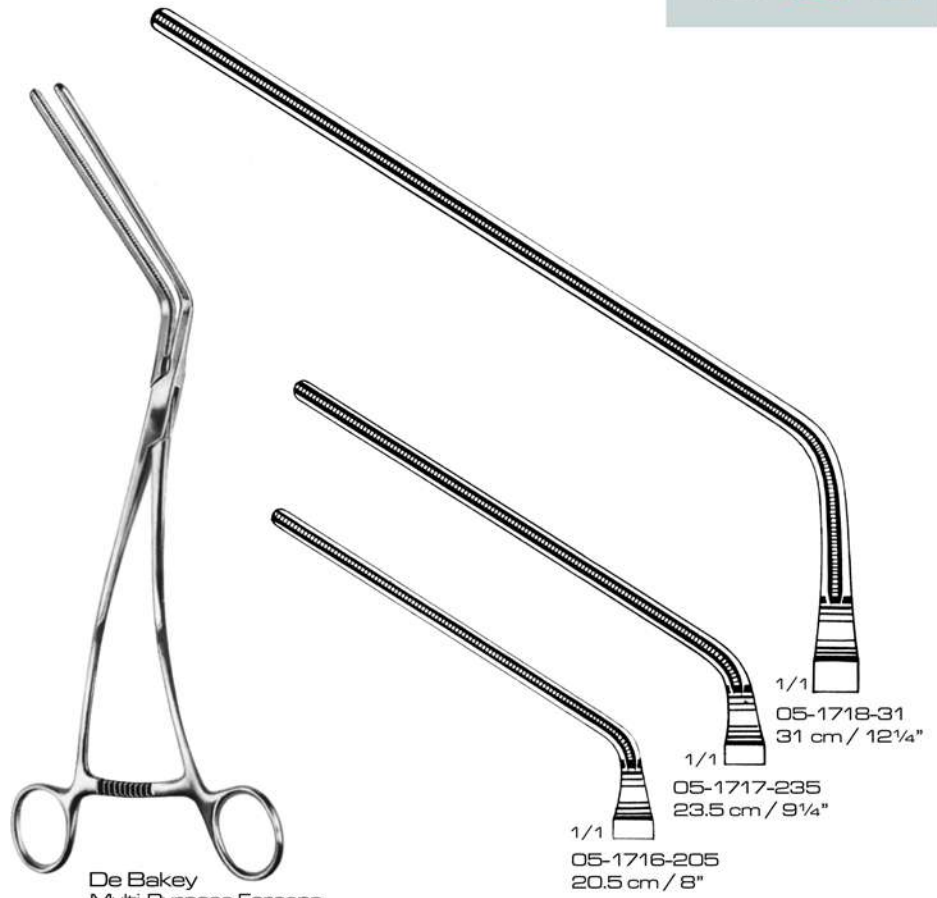

De Bakey
Multi-Purpose Forceps,
angled 60°

05-1716-205
20.5 cm / 8"
05-1717-235
23.5 cm / 9¹/₄"
05-1718-31
31 cm / 12¹/₄"

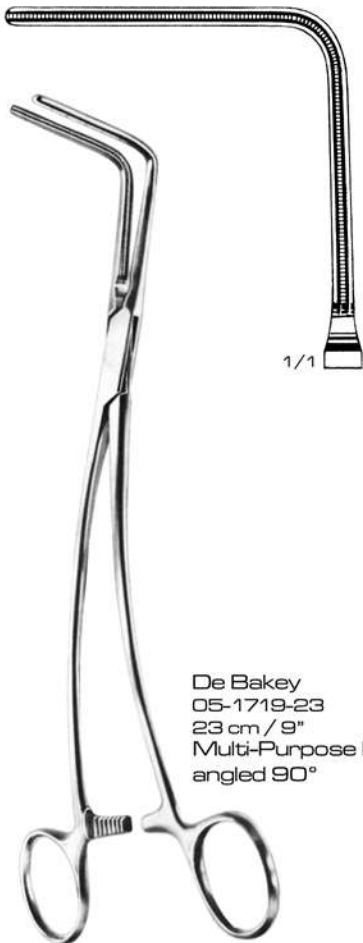

De Bakey
05-1719-23
23 cm / 9"
Multi-Purpose Forceps,
angled 90°

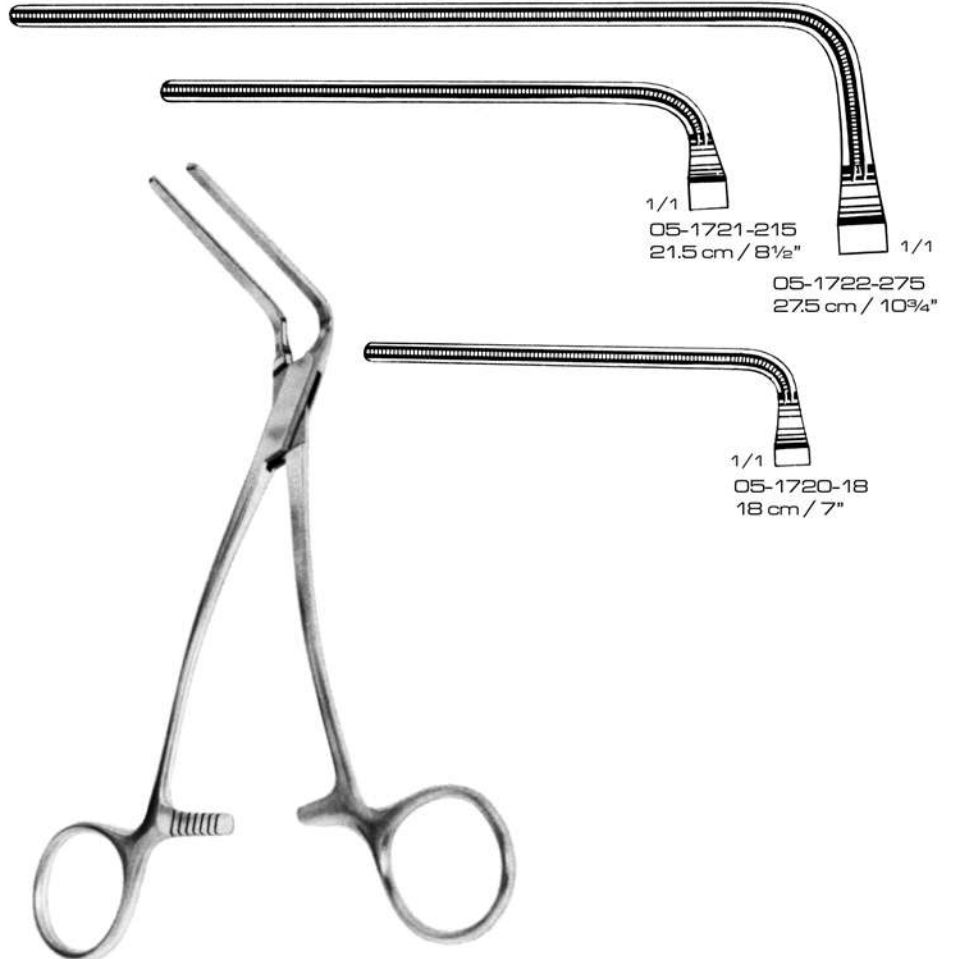

De-Bakey
Multi-Purpose Forceps, angled 90°

05-1721-215
21.5 cm / 8¹/₂"
05-1722-275
27.5 cm / 10³/₄"
05-1720-18
18 cm / 7"



De Bakey-Satinsky
Vena cava clamps

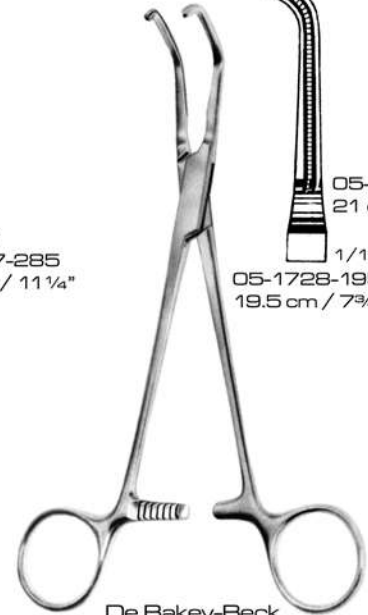
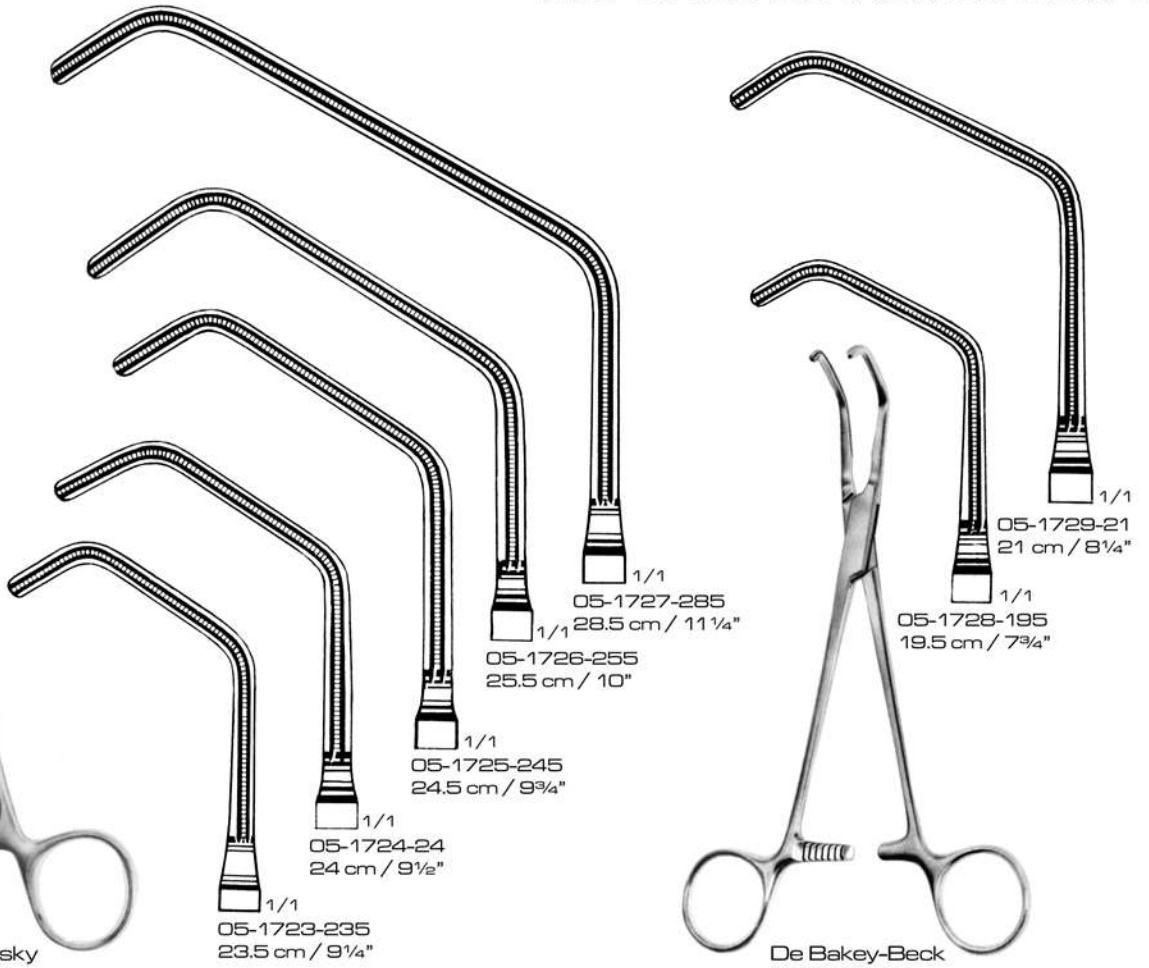

De Bakey-Beck
Aortic Forceps



De Bakey-Crafoord

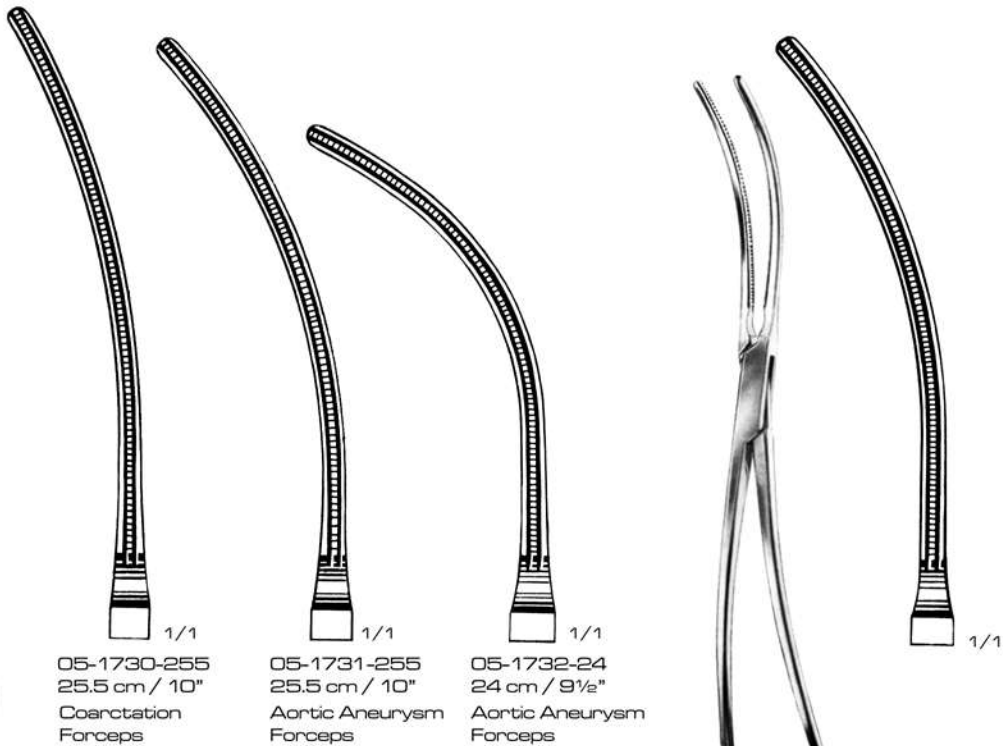

De Bakey-Crafoord (mod.)
05-1733-26
26 cm / 10¹/₄"
Aortic Aneurysm Clamps

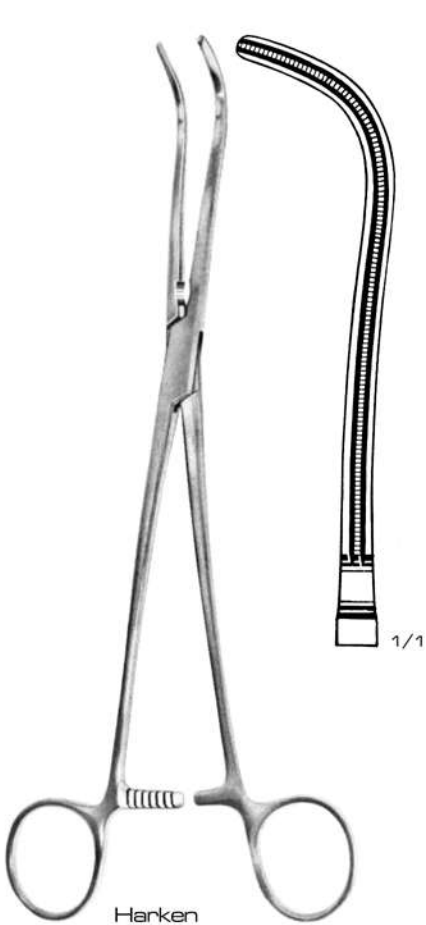

Harken
05-1734-24
24 cm / 9½"
Thorax and Auricle Forceps

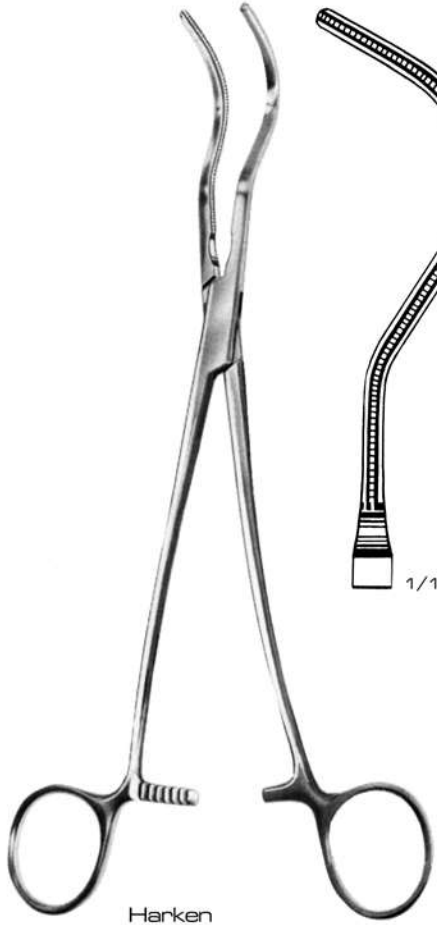

Harken
05-1735-24
24 cm / 9½"
Thorax and Auricle Forceps

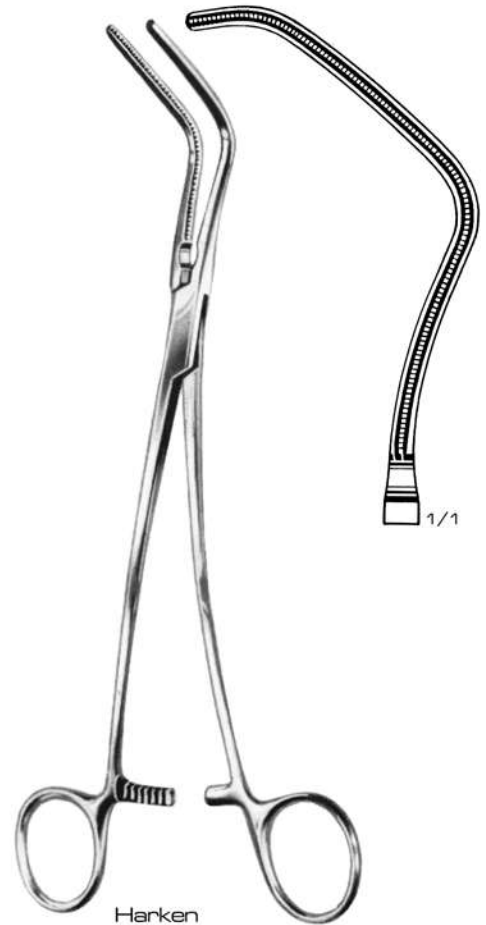

Harken
05-1736-24
24 cm / 9½"
Thorax and Auricle Forceps

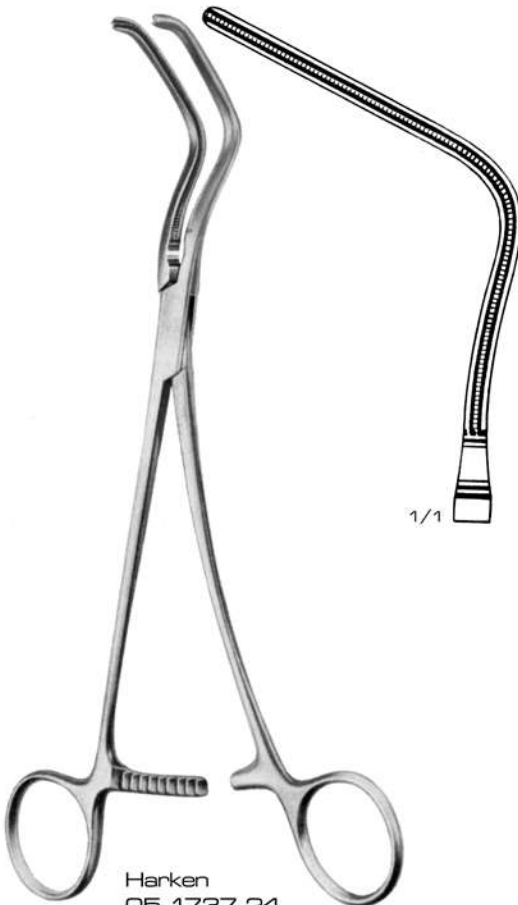

Harken
05-1737-24
24 cm / 9½"
Thorax and Auricle Forceps



Bailey
Aortic Forceps

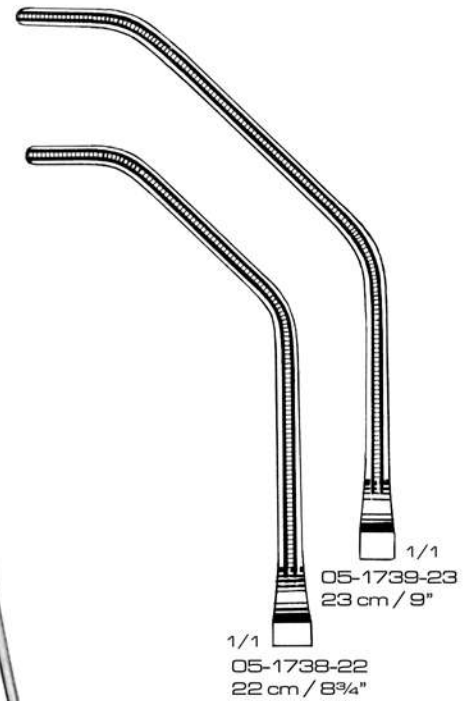

1/1
05-1738-22
22 cm / 8¾"

1/1
05-1739-23
23 cm / 9"

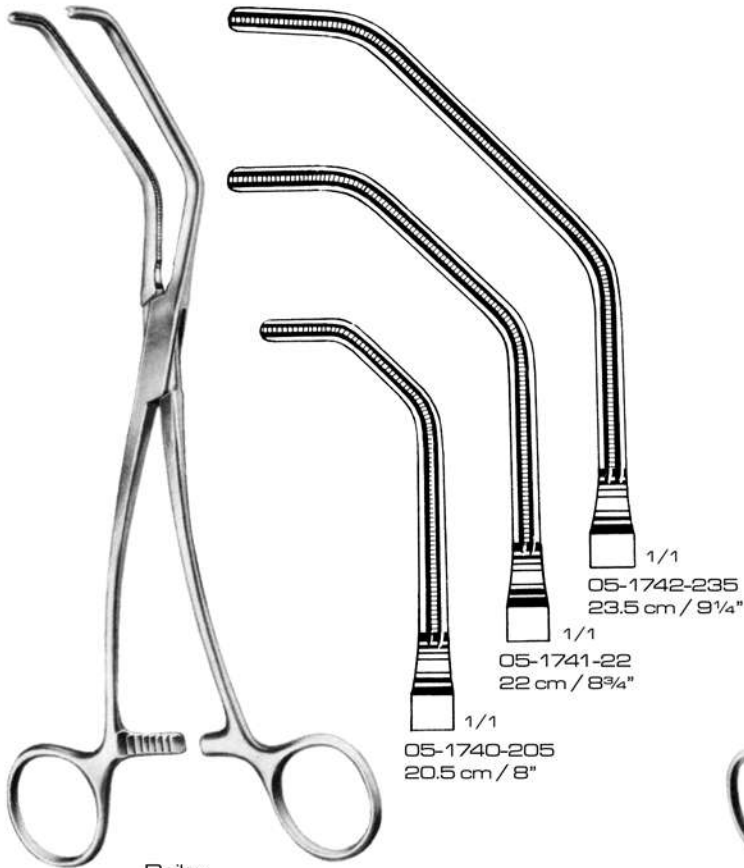

Bailey
Aortic Forceps

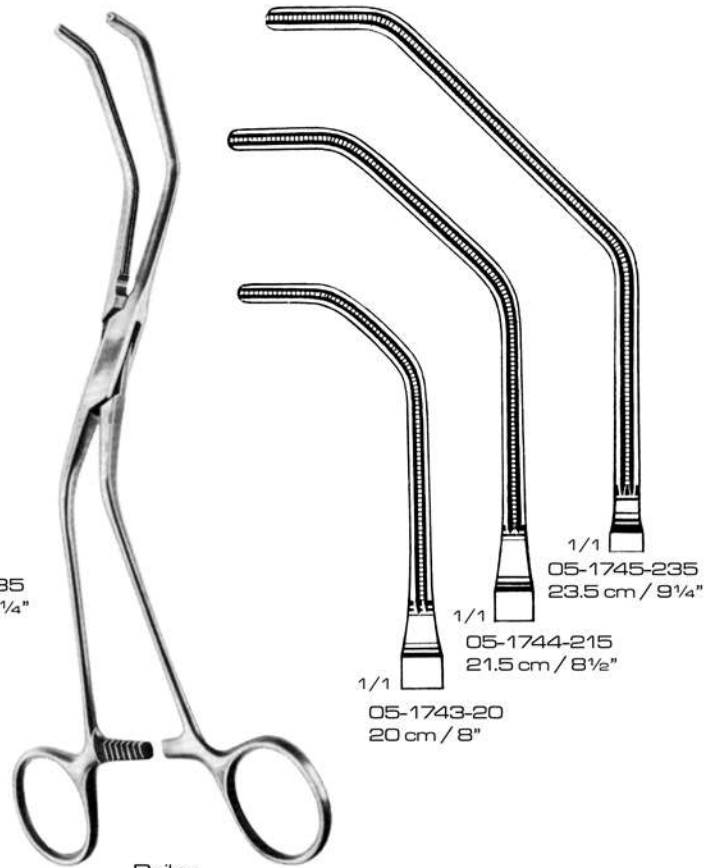

Bailey
Aortic Forceps

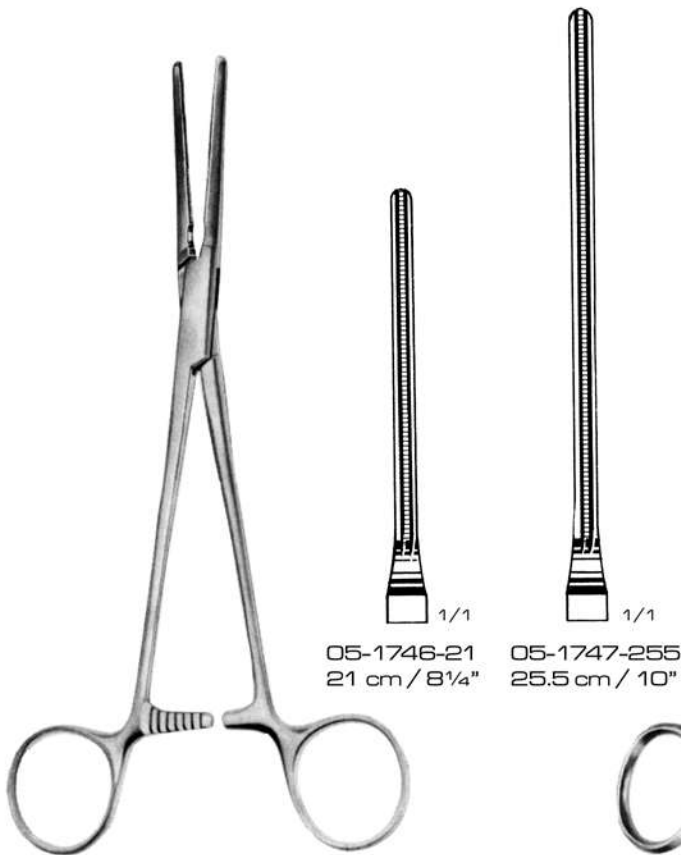

Glover
Coarctation Forceps

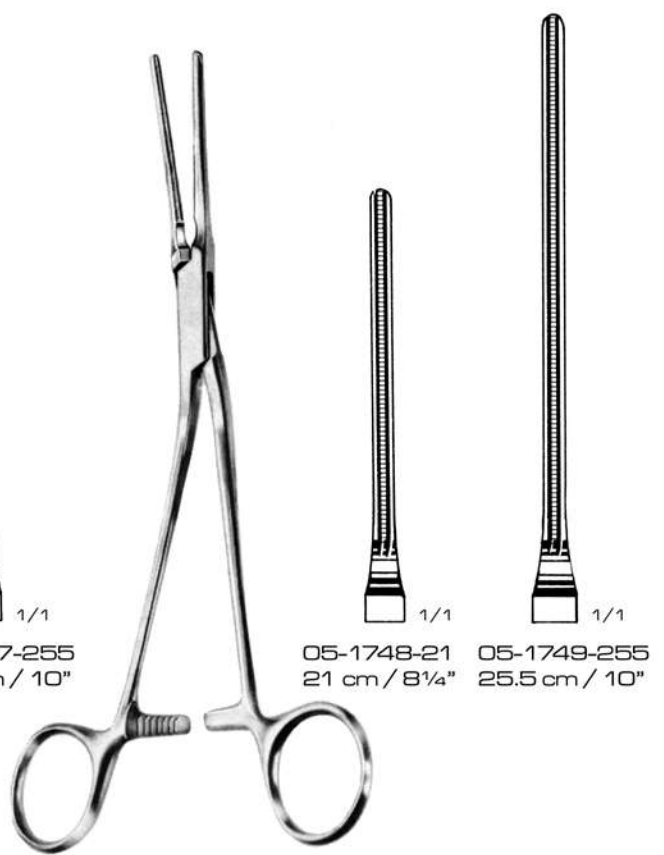

Glover
Coarctation Forceps

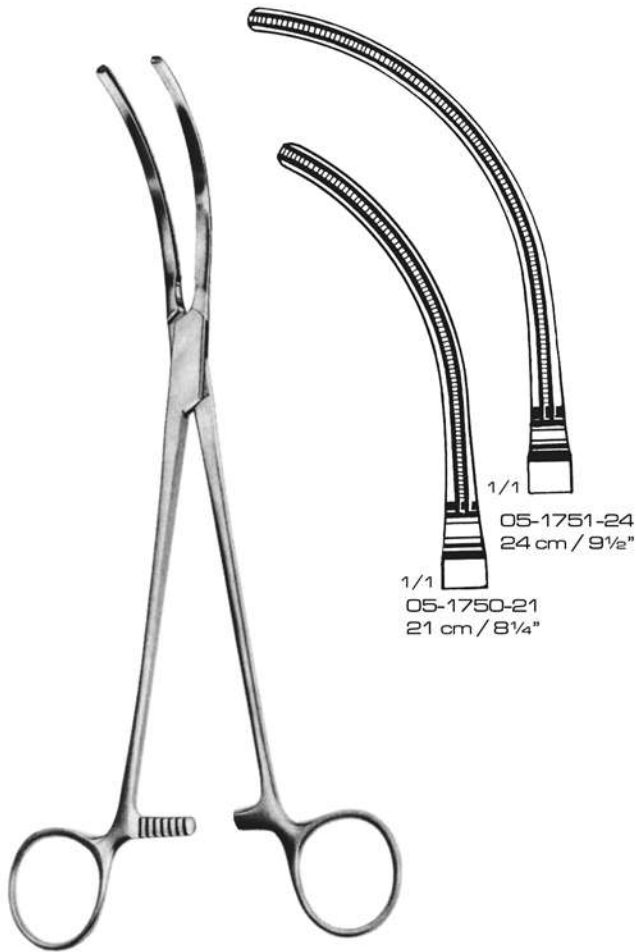

1/1
05-1751-24
24 cm / 9½"

1/1
05-1750-21
21 cm / 8¼"

Glover

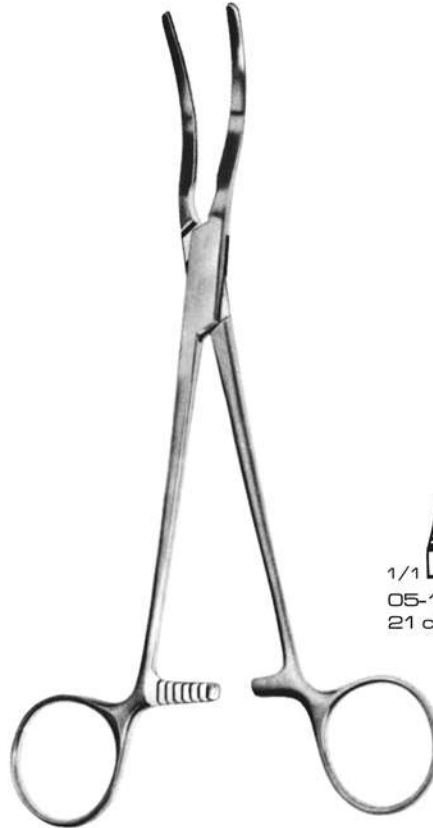

1/1
05-1753-26
26 cm / 10¼"

1/1
05-1752-21
21 cm / 8¼"

Glover

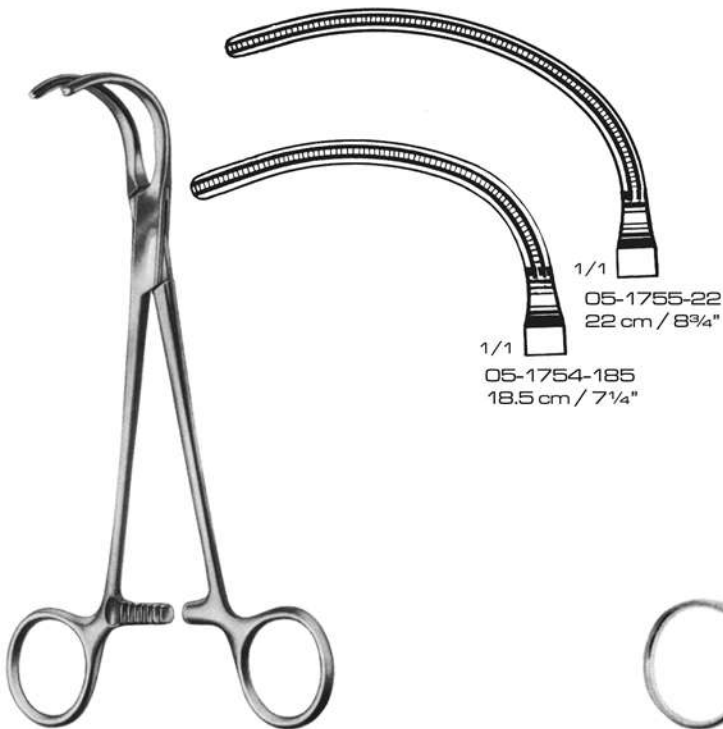

1/1
05-1755-22
22 cm / 8¾"

1/1
05-1754-185
18.5 cm / 7¼"

Glover

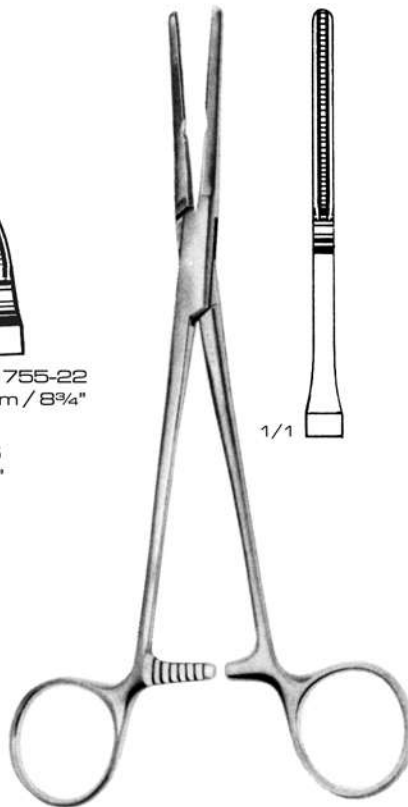

Glover
05-1756-205
20.5 cm / 8"
Patent Ductus Forceps

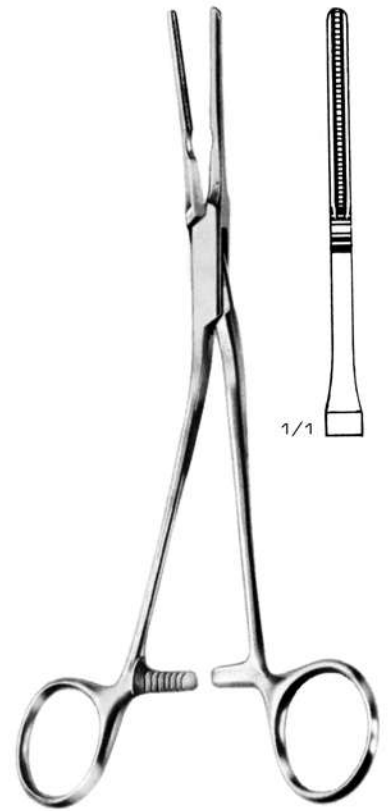

Glover
05-1757-205
20.5 cm / 8"
Patent Ductus Forceps

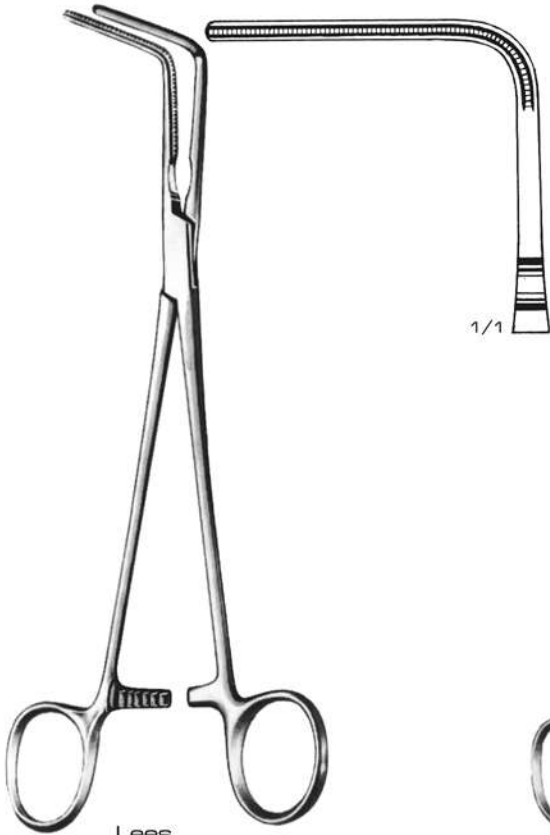

Lees
05-1758-22
22 cm / 8³/₄"

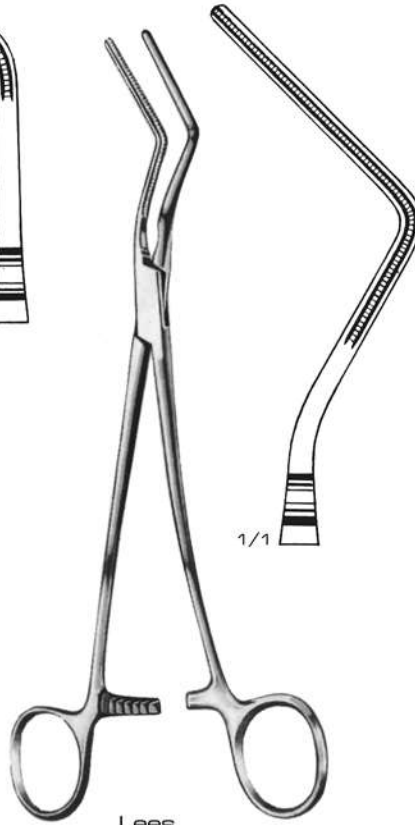

Lees
05-1759-25
25 cm / 9³/₄"

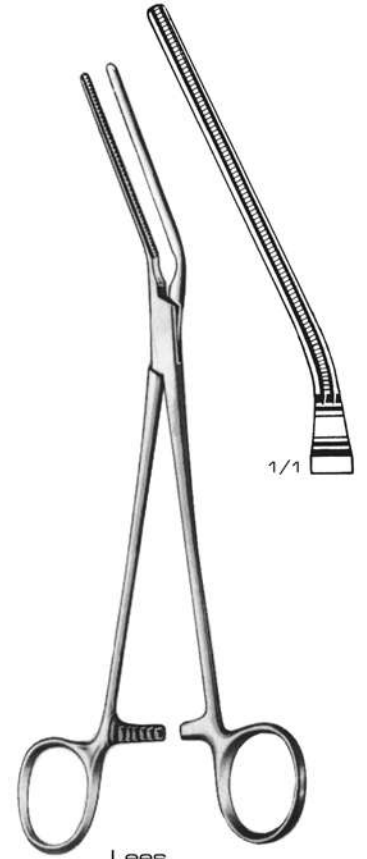

Lees
05-1760-215
21.5 cm / 8¹/₂"

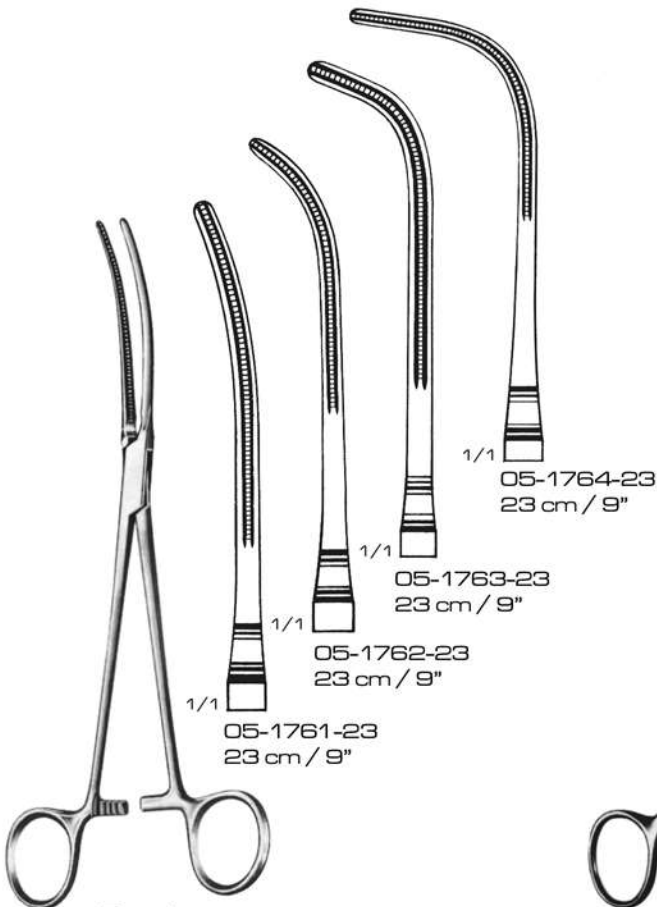

Rumel

05-1761-23
23 cm / 9"

05-1762-23
23 cm / 9"

05-1763-23
23 cm / 9"

05-1764-23
23 cm / 9"

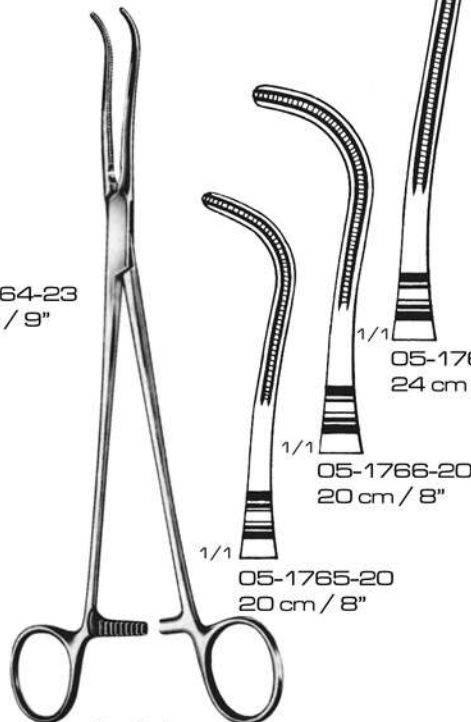

De Bakley

05-1765-20
20 cm / 8"

05-1766-20
20 cm / 8"

05-1767-24
24 cm / 9¹/₂"

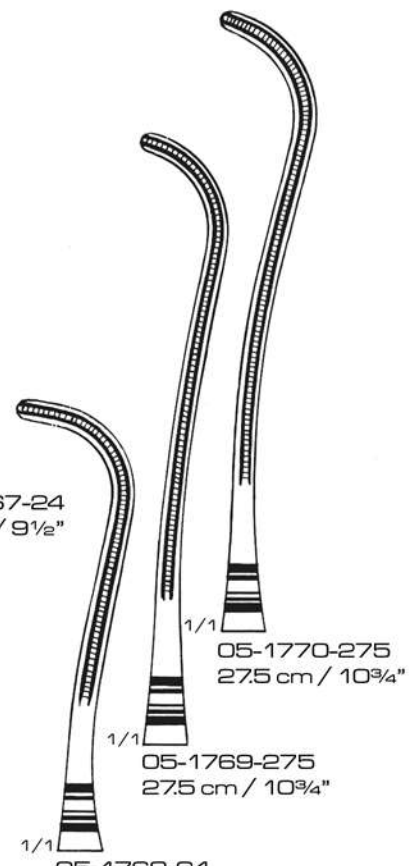

05-1768-24
24 cm / 9¹/₂"

05-1769-275
27.5 cm / 10³/₄"

05-1770-275
27.5 cm / 10³/₄"

NON-TRAUMATIC VASCULAR CLAMPS

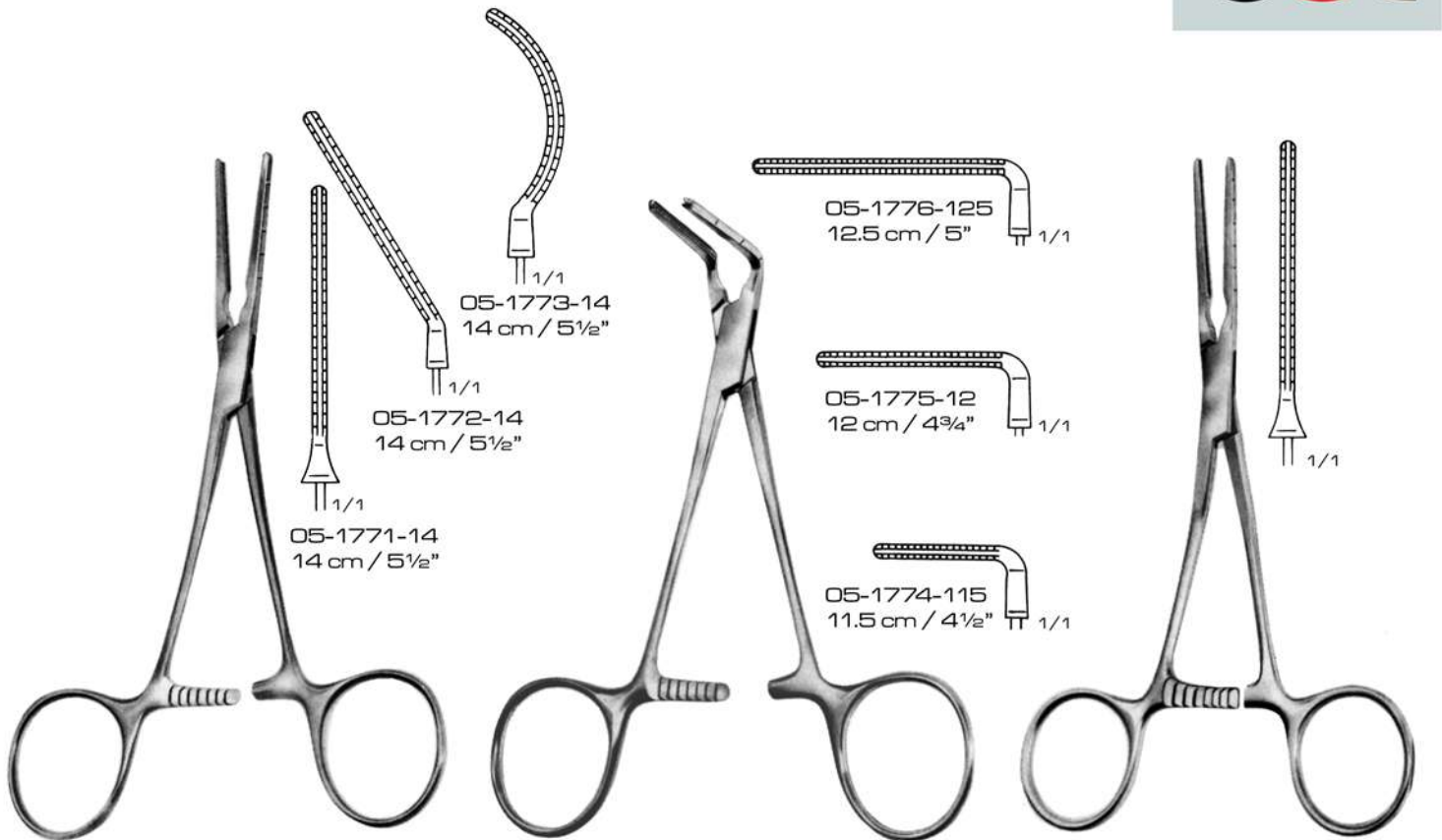

Cooley

Cooley

Cooley
05-1777-14
14 cm / 5½"

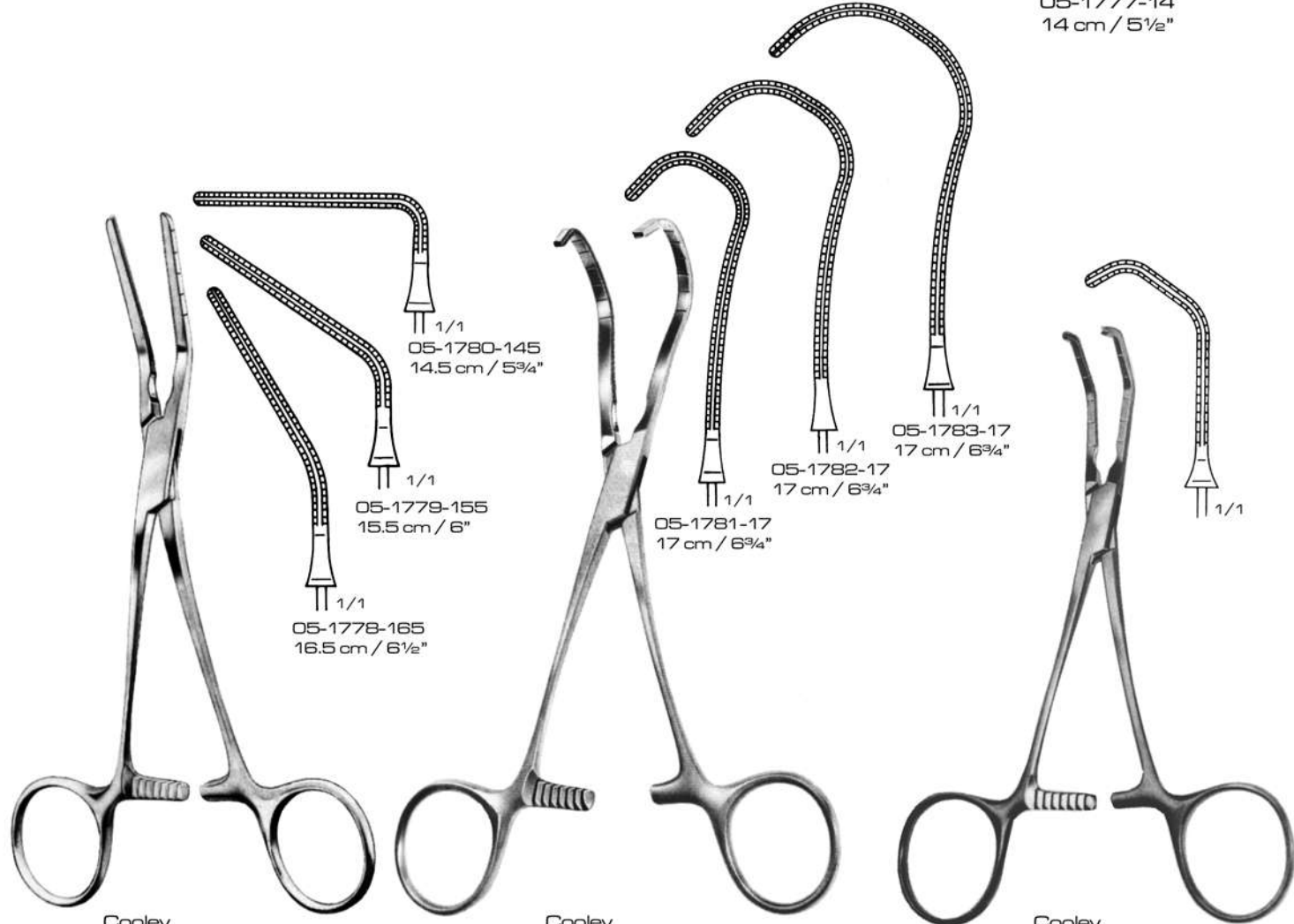

Cooley
Multi-Purpose Forceps

Cooley
Anastomosis Forceps

Cooley
05-1784-14
14 cm / 5½"

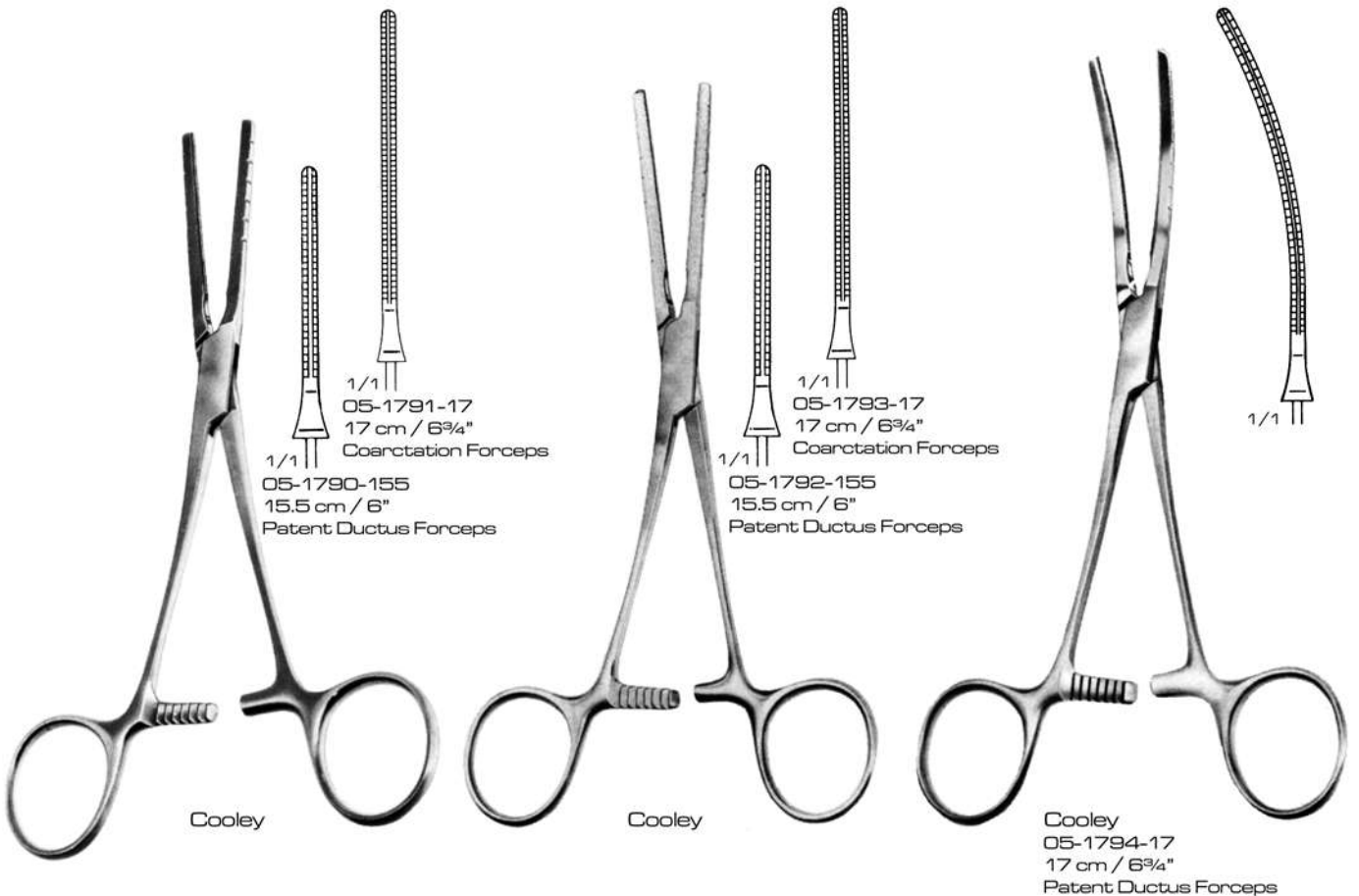
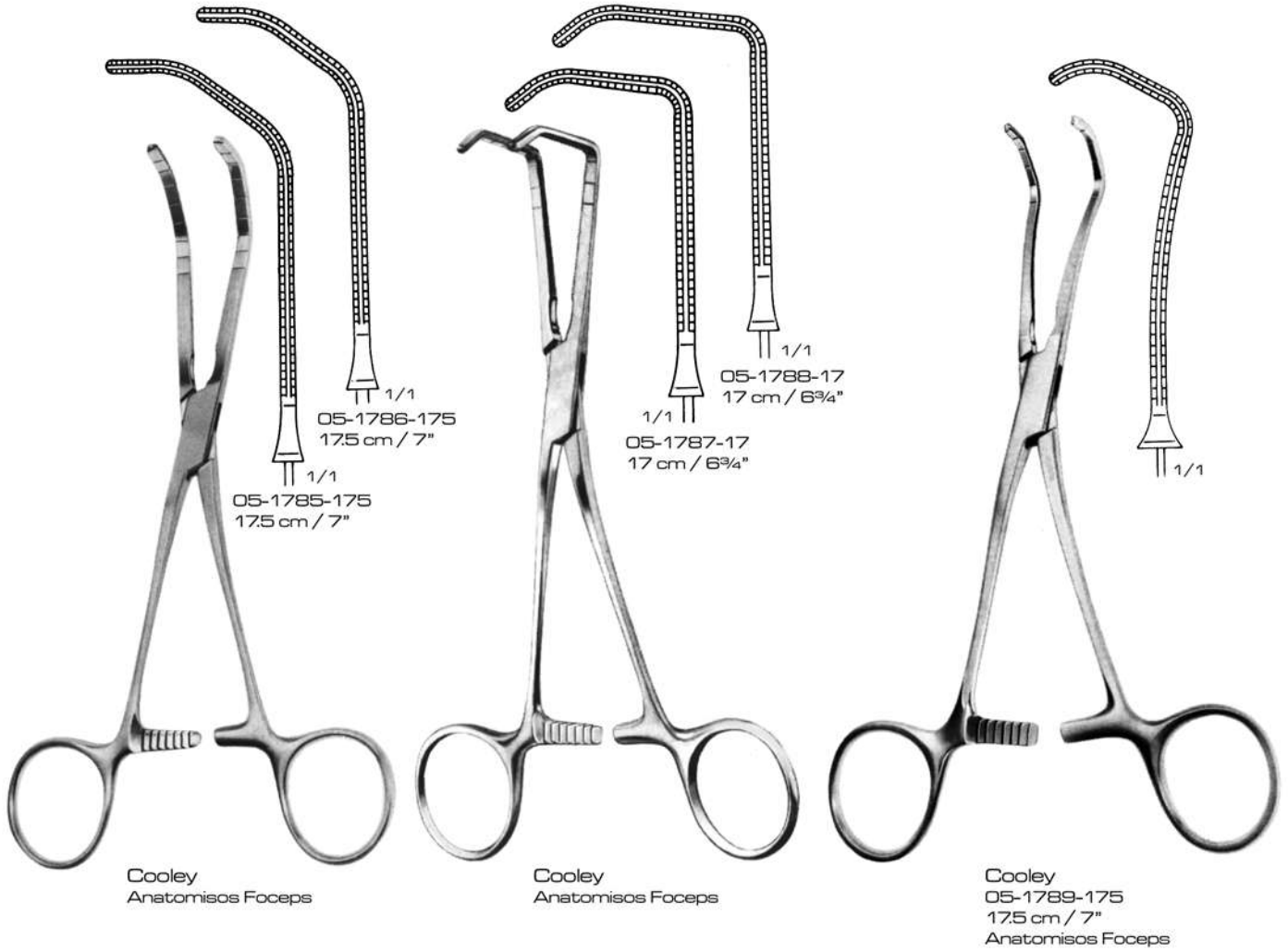

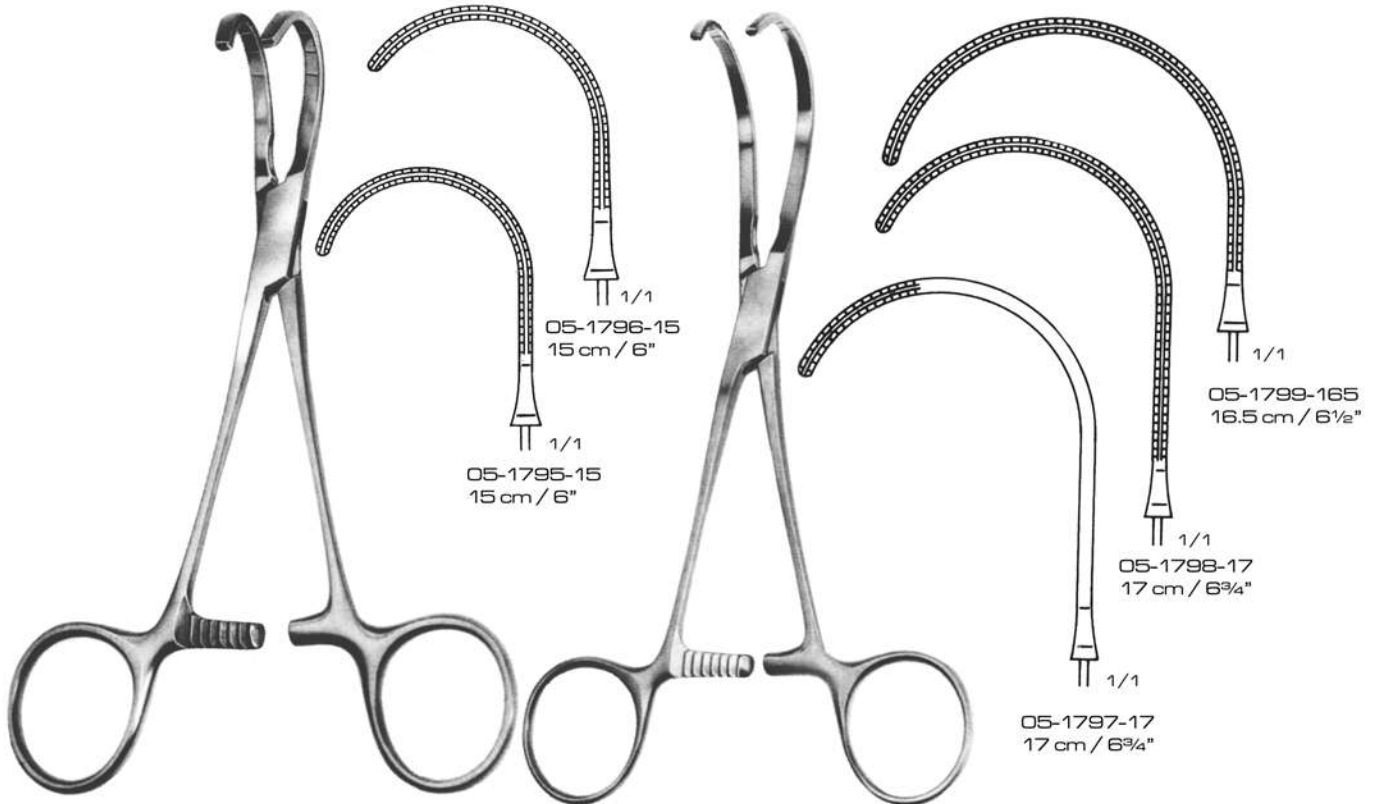

Cooley-Beck

Cooley
Ligature Carrier

05-1796-15
15 cm / 6"
1/1

05-1795-15
15 cm / 6"
1/1

05-1799-165
16.5 cm / 6½"
1/1

05-1798-17
17 cm / 6¾"
1/1

05-1797-17
17 cm / 6¾"
1/1

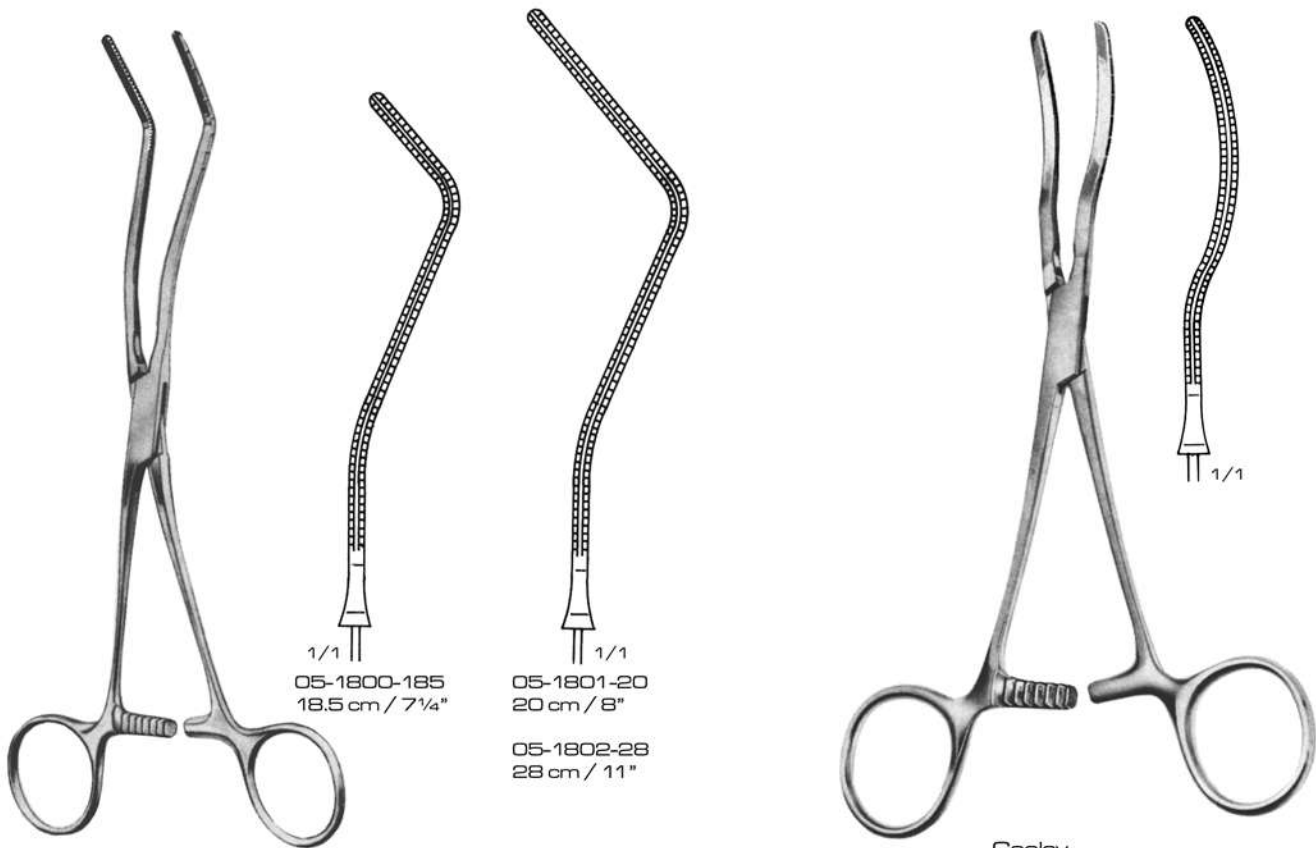

Cooley
Renal Artery Clamps - also used
for subclavian and carotid artery

Cooley
05-1803-17.5
17.5 cm / 7"
Coarctation Forceps

05-1800-185
18.5 cm / 7¼"
1/1

05-1801-20
20 cm / 8"
1/1

05-1802-28
28 cm / 11"
1/1



Cooley

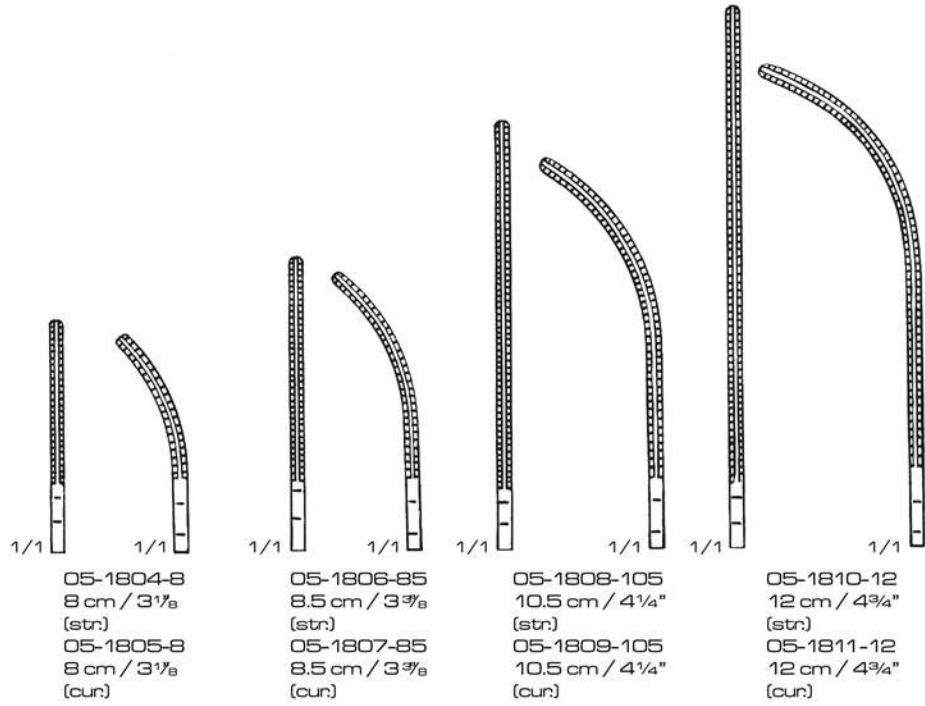

Cooley

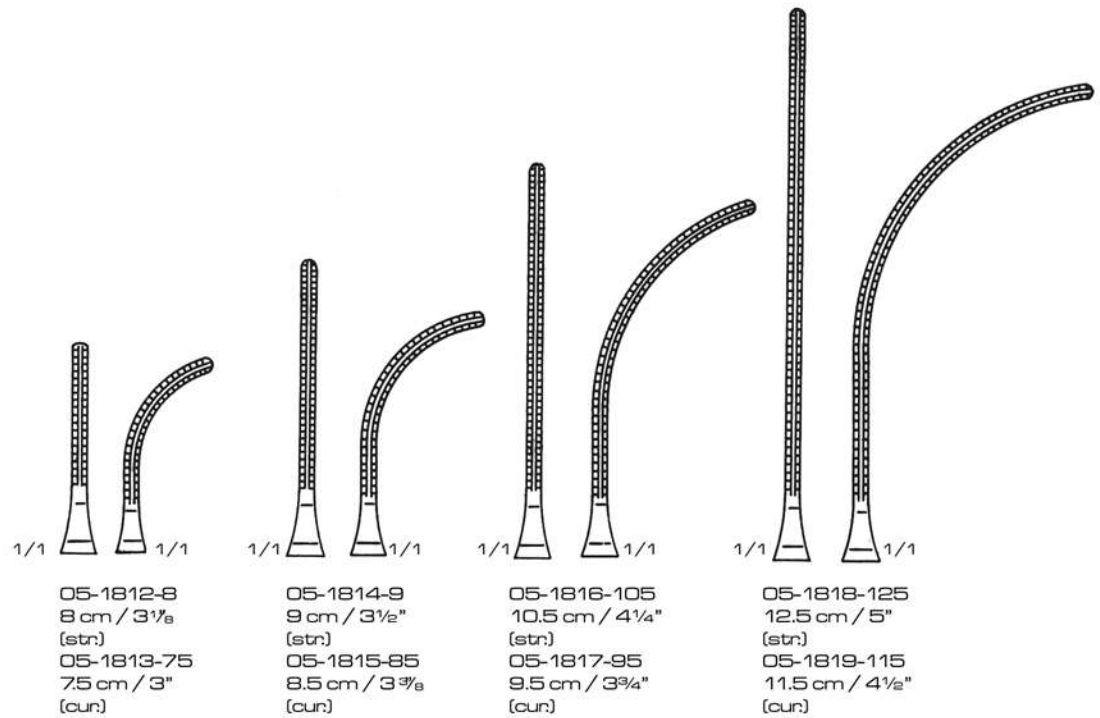

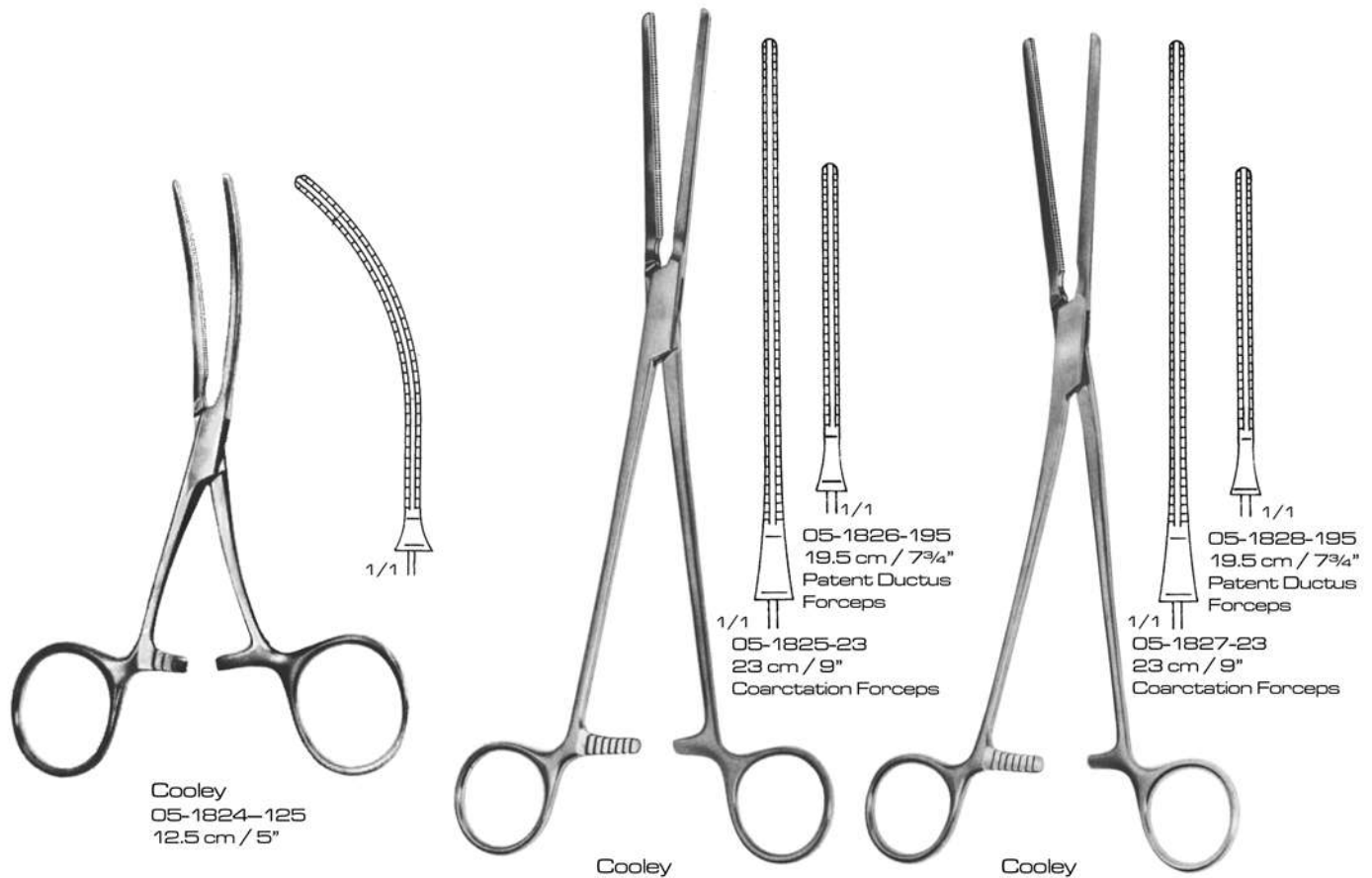
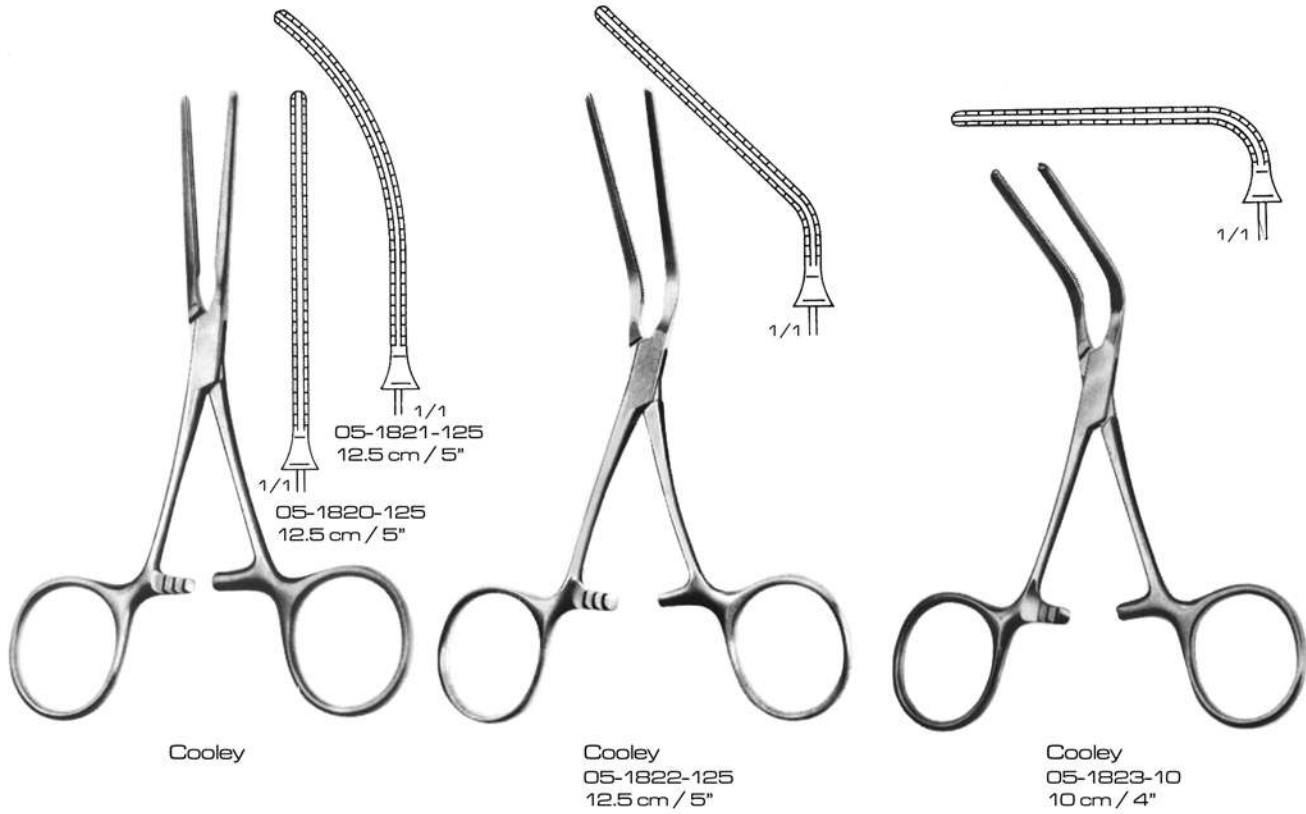

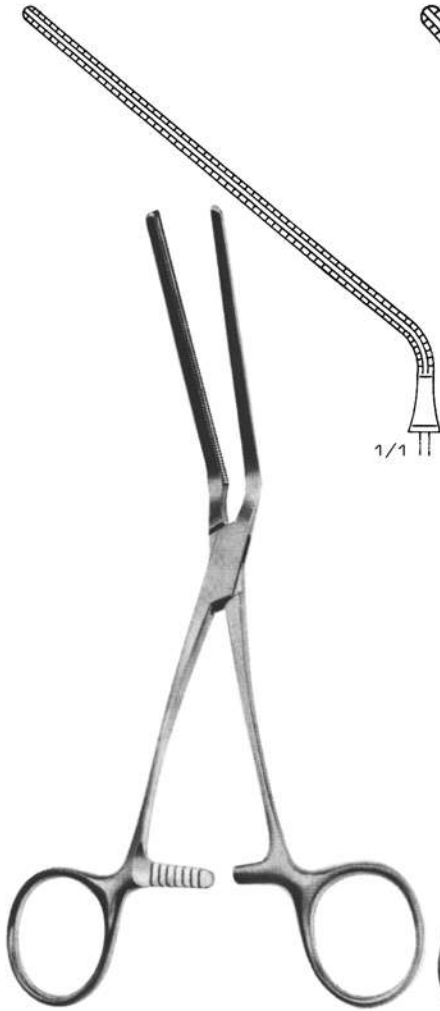

Cooley
05-1829-18
18 cm / 7"
Peripheral Vascular Forceps

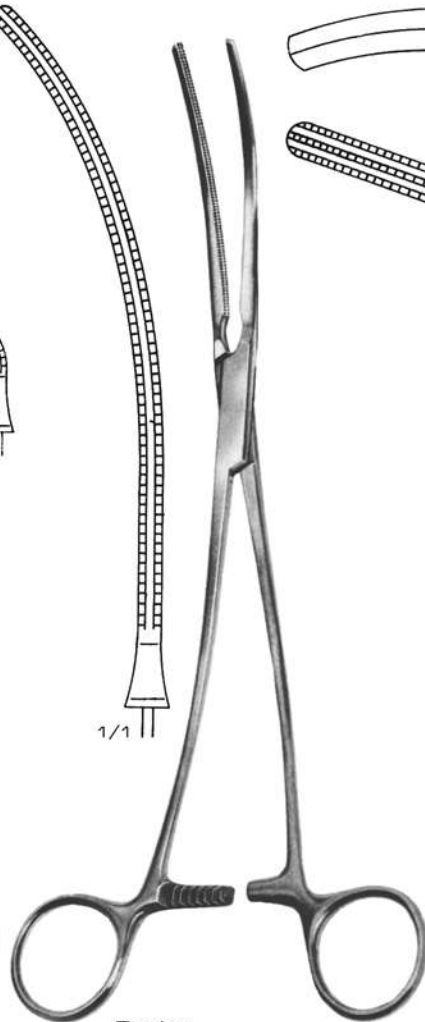

Cooley
05-1830-265
26.5 cm / 10½"
Aortic Aneurysm Clamps

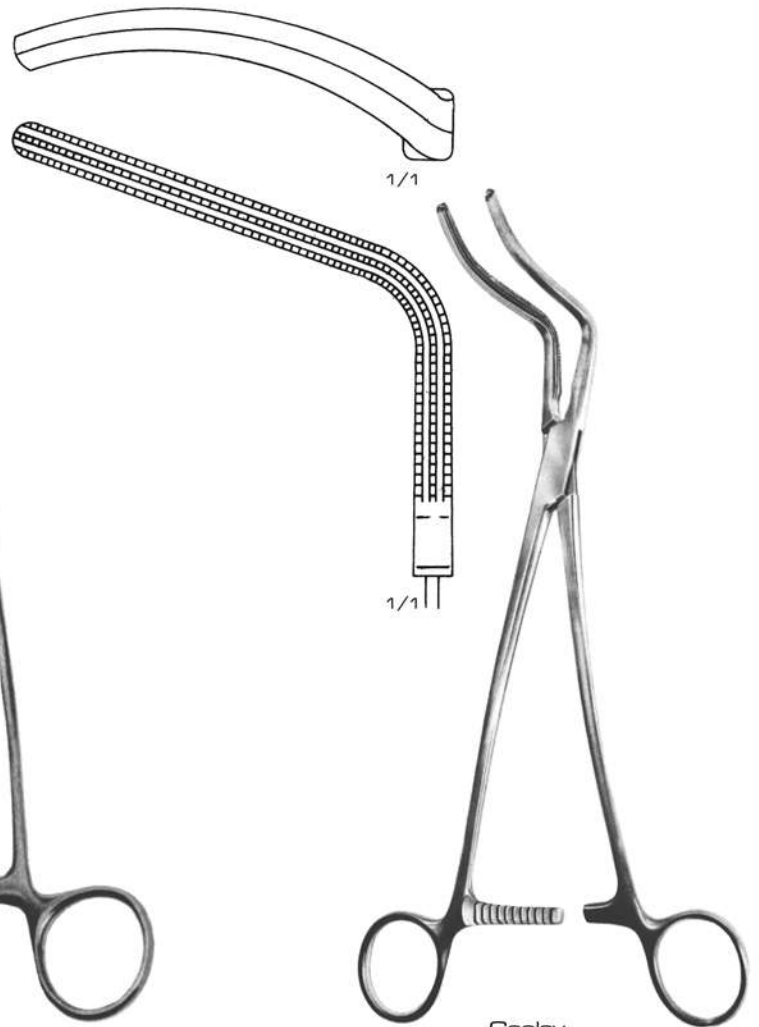

Cooley
05-1831-265
26.5 cm / 10½"
Aortic Forceps

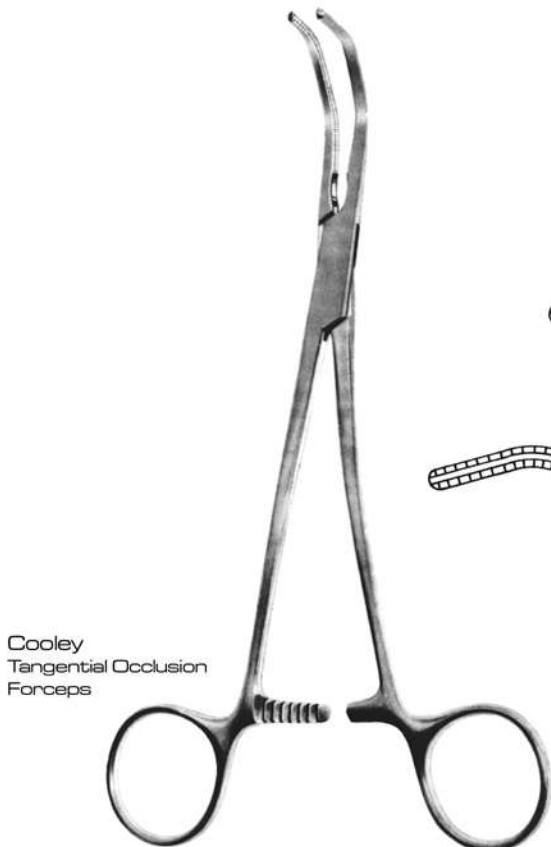

Cooley
Tangential Occlusion
Forceps

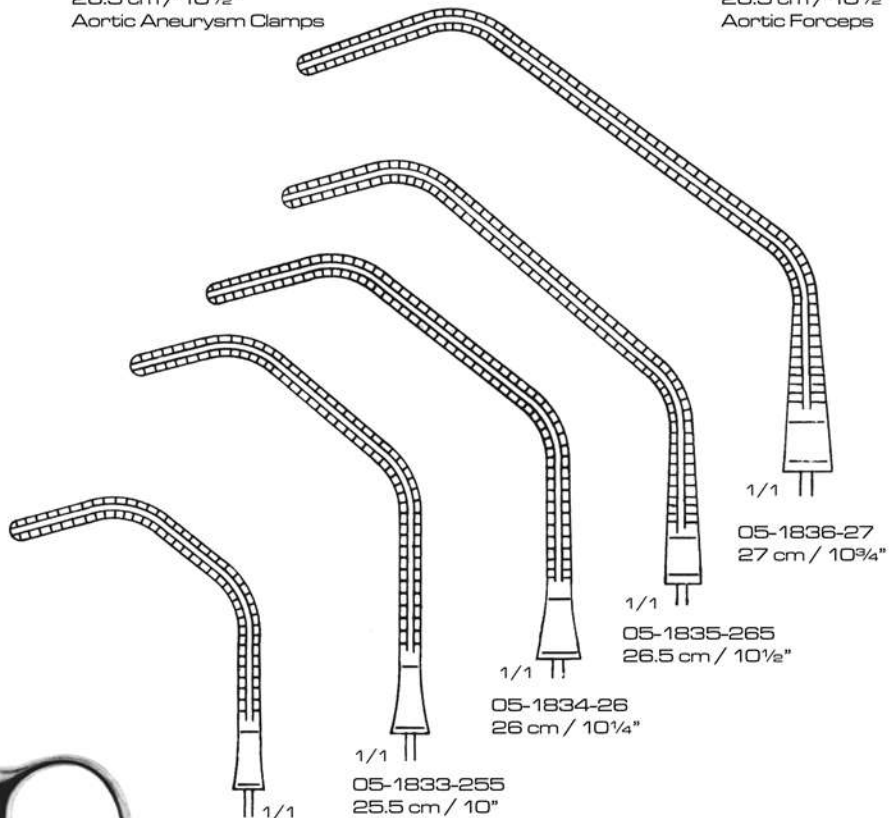

05-1832-195
19.5 cm / 7¾"

05-1833-255
25.5 cm / 10"

05-1834-26
26 cm / 10¼"

05-1835-265
26.5 cm / 10½"

05-1836-27
27 cm / 10¾"

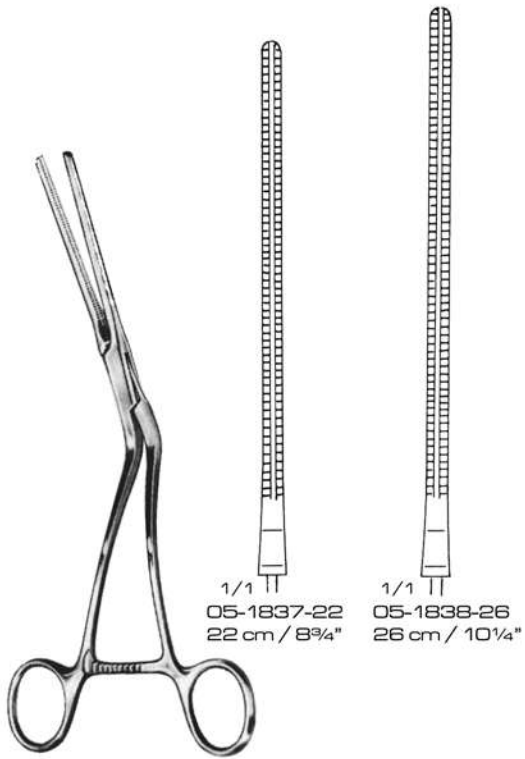

1/1
05-1837-22
22 cm / 8³/₄"

1/1
05-1838-26
26 cm / 10¹/₄"

Cooley
Iliac Clamps

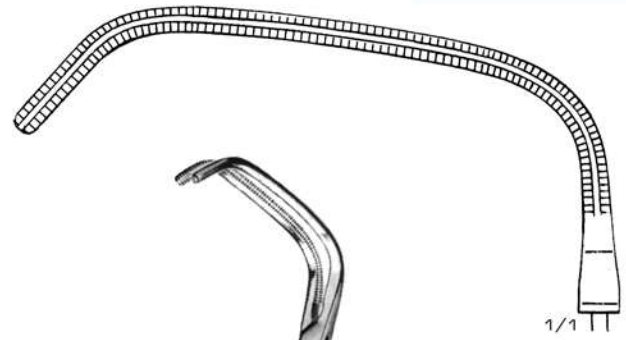

1/1

Cooley
05-1839-26
26 cm / 10¹/₄"
Aortic Forceps

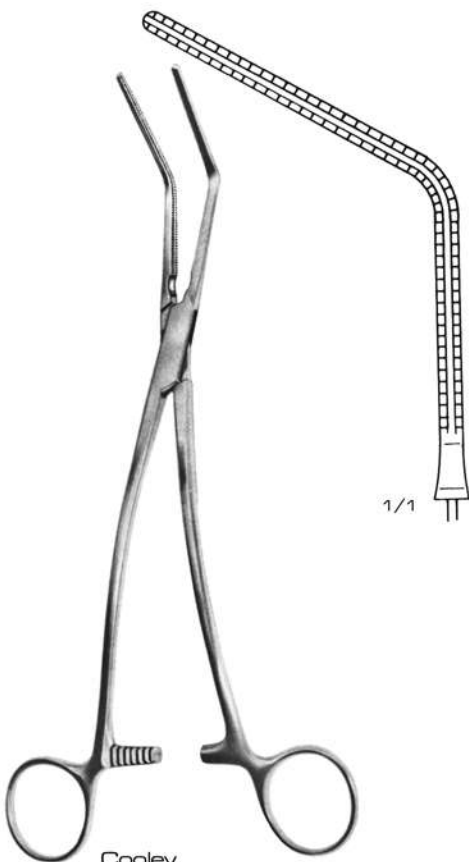

1/1

Cooley
05-1840-25
25 cm / 9³/₄"
Multi-Purpose Forceps,
Angled 60°



Cooley
Multi-Purpose Forceps,
Angled 60°

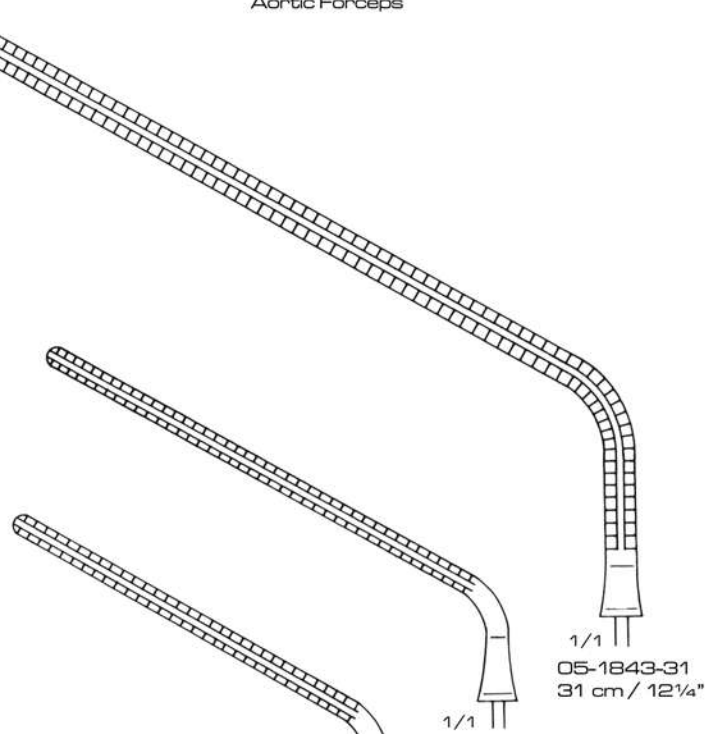

1/1
05-1842-235
23.5 cm / 9¹/₄"

1/1
05-1841-205
20.5 cm / 8"

1/1
05-1843-31
31 cm / 12¹/₄"

Micro Surgery

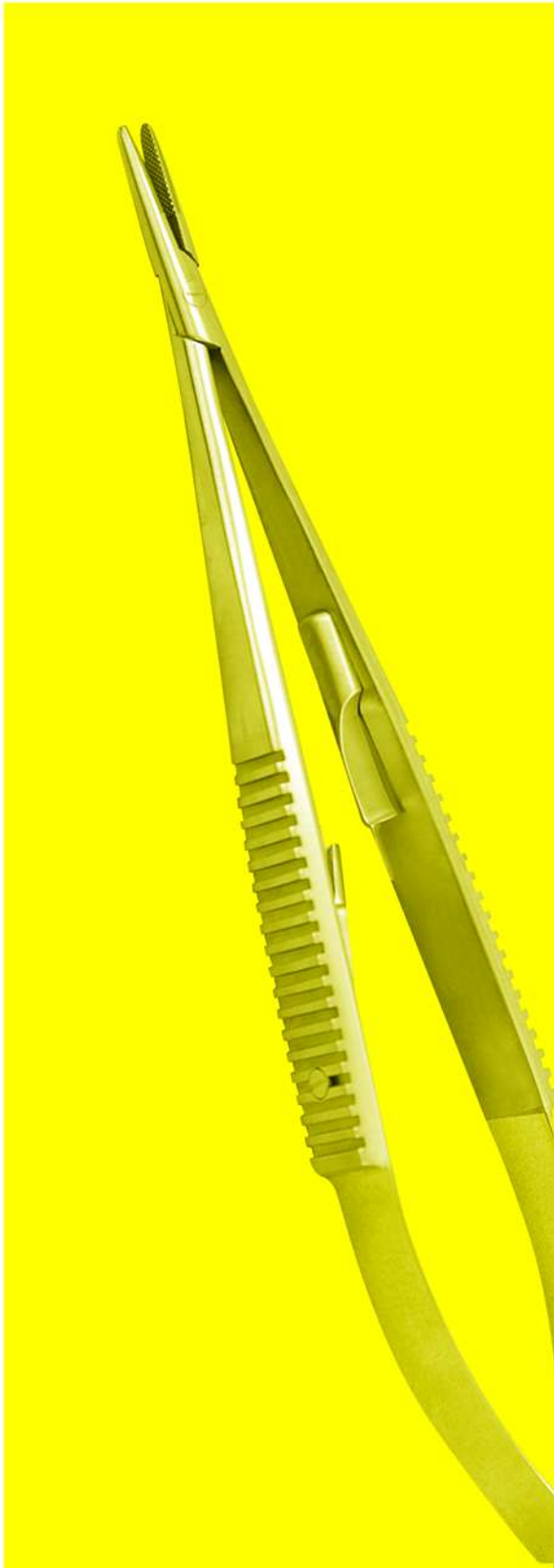

OGE
ORTHOGENT
ENGINEERING



Barraquer
05-1844-16
16 cm / 6¼"

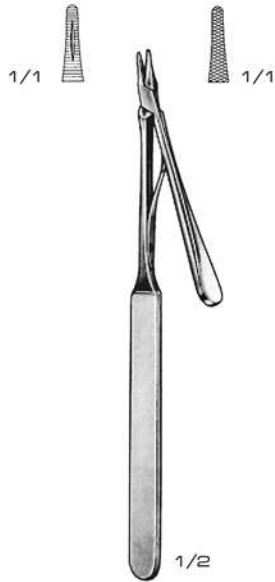

Barraquer
05-1845-14
14 cm / 5½"

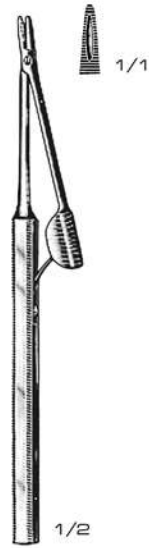

Berens
05-1846-14
14 cm / 5½"



Stevens
05-1847-13 13 cm / 5⅛"
05-1848-15 15 cm / 6"

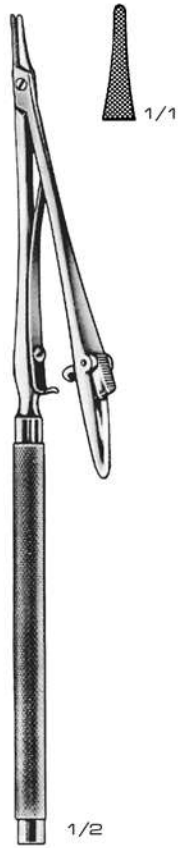

Potts-Smith
05-1849-22
22 cm / 8¾"



Cstroviejo-Kalt
05-1850-135
13.5 cm / 5¼"

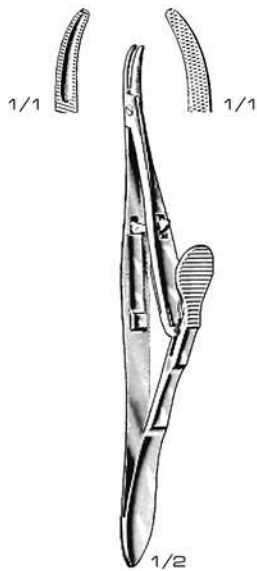

Kalt-Arruga
05-1851-14
14 cm / 5½"

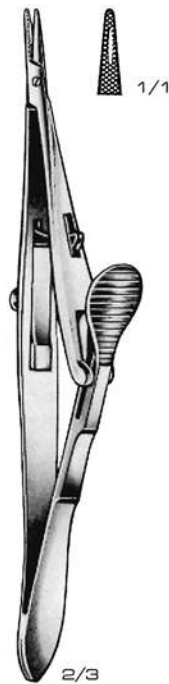

Kalt
05-1852-14
14 cm / 5½"



Arruga
05-1853-14
14 cm / 5½"



Arruga
05-1854-14
14 cm / 5½"



1/1
05-005-14
1/1
05-005-14

2/3

Barraquer
05-1855-14
14 cm / 5½"



1/1

1/2

Barraquer
05-1856-11
11 cm / 4¼"



1/1

1/2

Barraquer
05-1857-13
13 cm / 5⅛"



1/1

1/2

Barraquer
05-1858-14
14 cm / 5½"



1/1

1/2

Barraquer
05-1859-13
13 cm / 5⅛"



1/1

2/3

Noyes
05-1860-14
14 cm / 5½"



1/1

1/1

Barraquer-Troutman
05-1861-10
10 cm / 4"

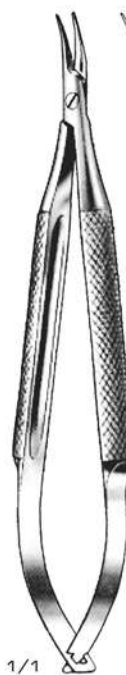

1/1

1/1

Barraquer-Troutman
05-1862-10
10 cm / 4"



1/1

1/1

Barraquer-Troutman
05-1863-10
10 cm / 4"



1/1

1/1

Barraquer-Troutman
05-1864-10
10 cm / 4"

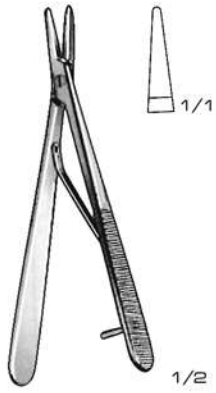

Rohrschneider
05-1865-10
10 cm / 4"



Castroviejo
05-1866-9
9 cm / 3 1/2"

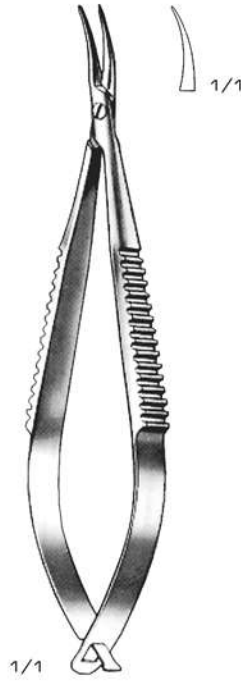

Castroviejo
05-1867-9
9 cm / 3 1/2"

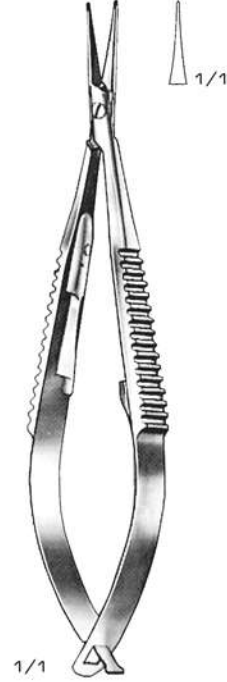

Castroviejo
05-1868-9
9 cm / 3 1/2"



Castroviejo
05-1869-9
9 cm / 3 1/2"

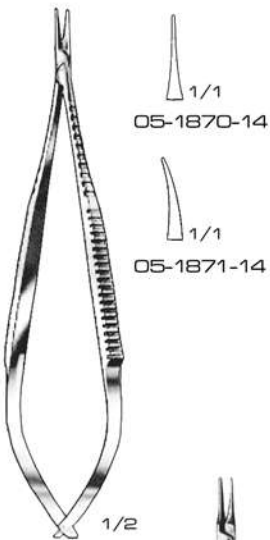

Castroviejo
14 cm / 5 1/2"

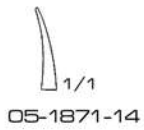
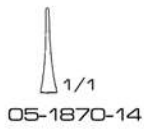

Castroviejo
14 cm / 5 1/2"

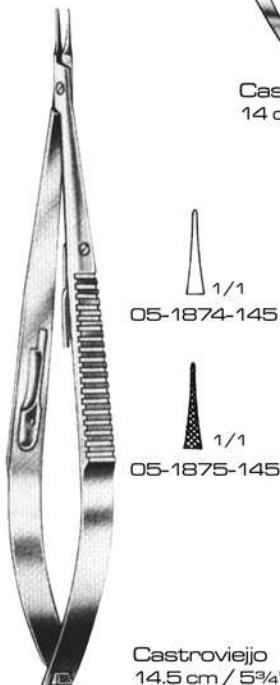
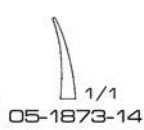
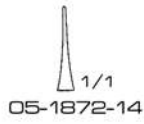

Castroviejo
14.5 cm / 5 3/4"

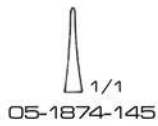

Castroviejo
14 cm / 5 1/2"

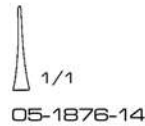

Paton
11 cm / 5 1/2"

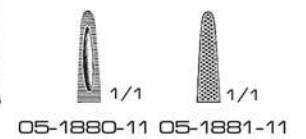
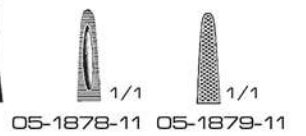

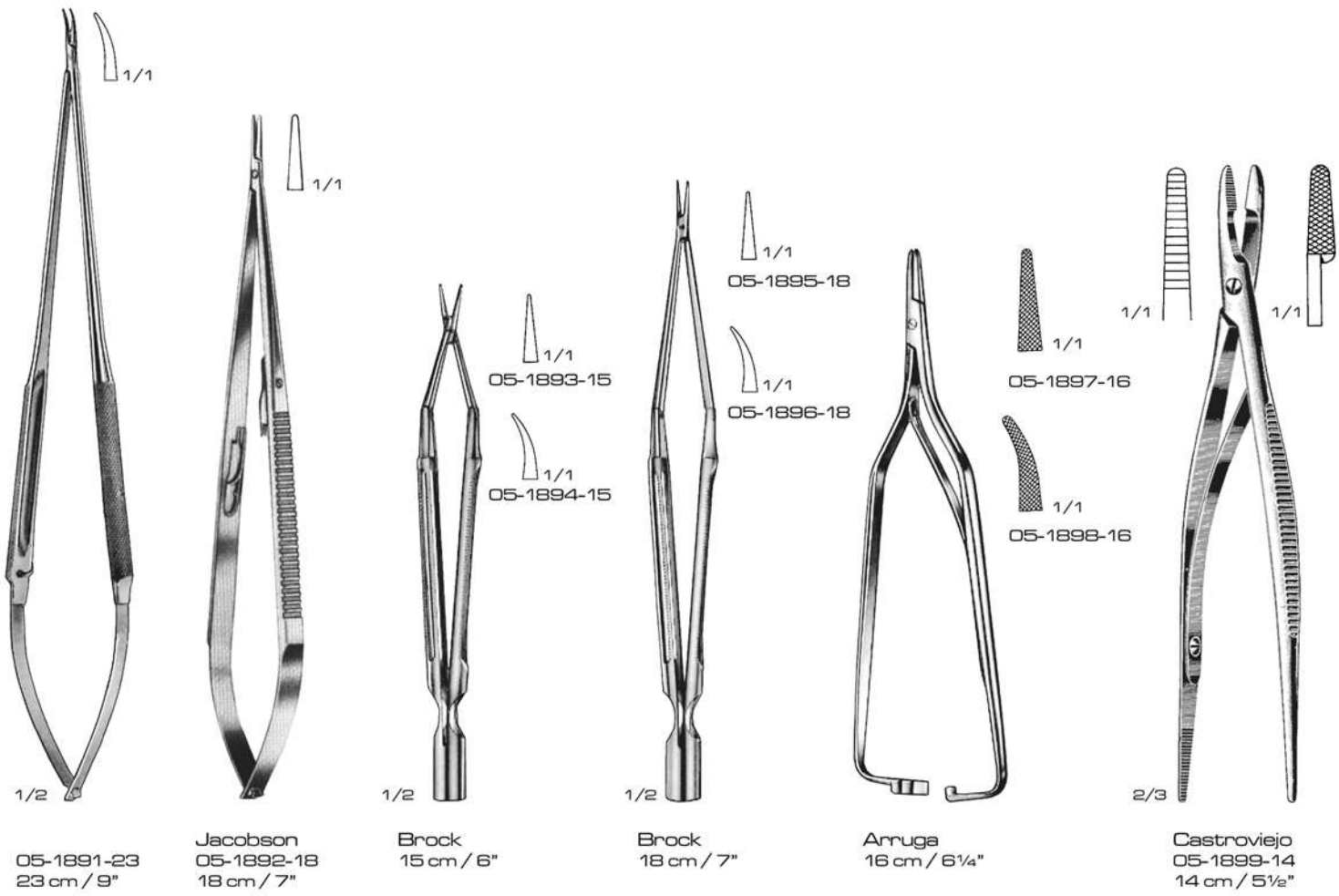
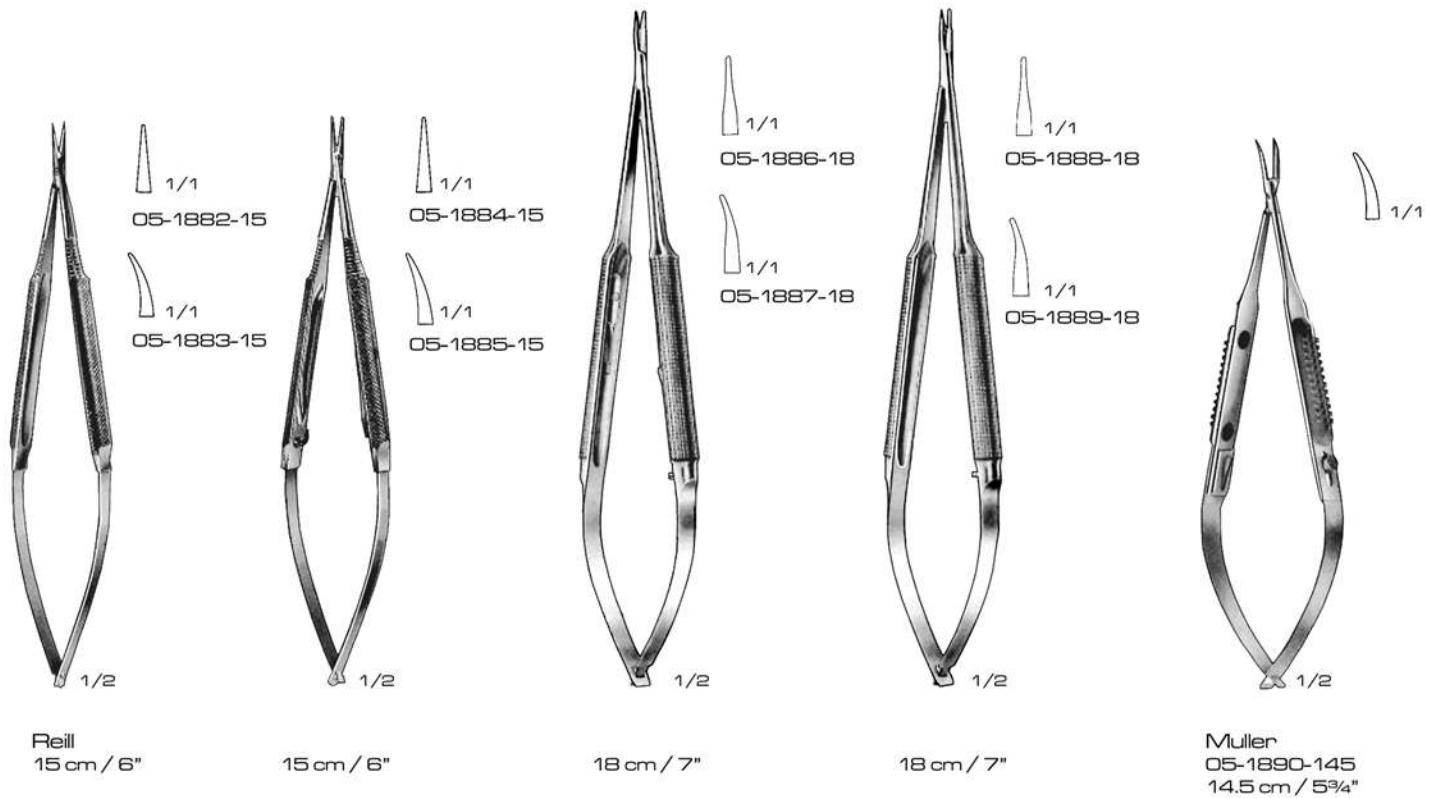

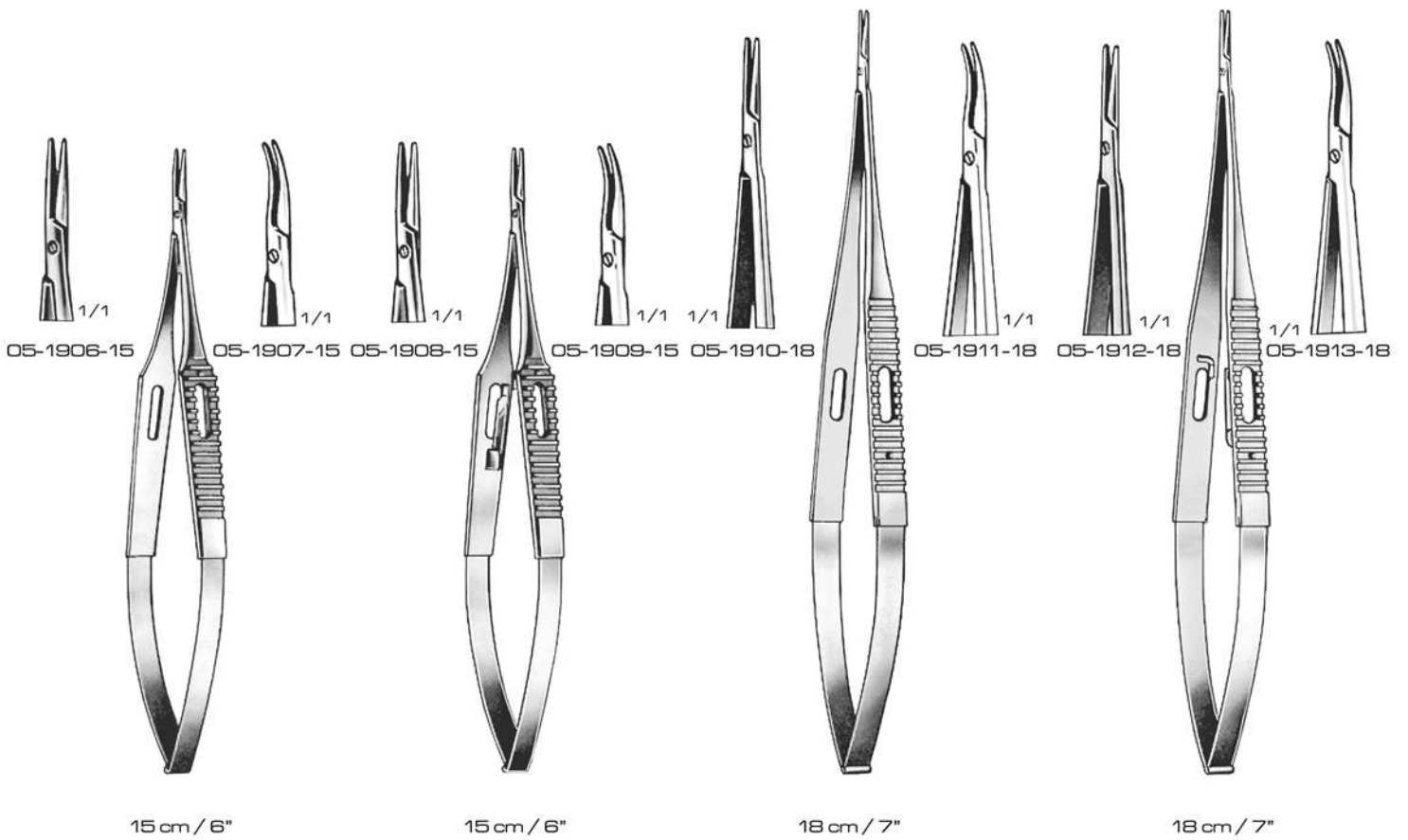
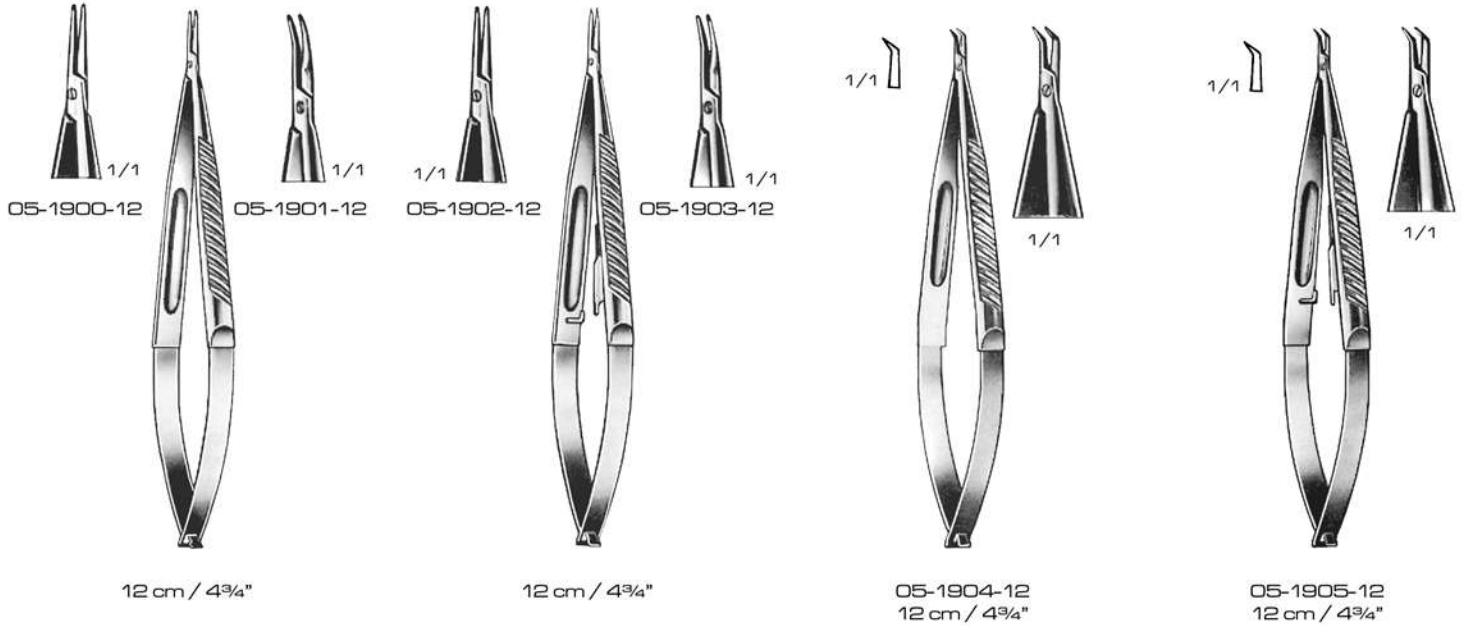

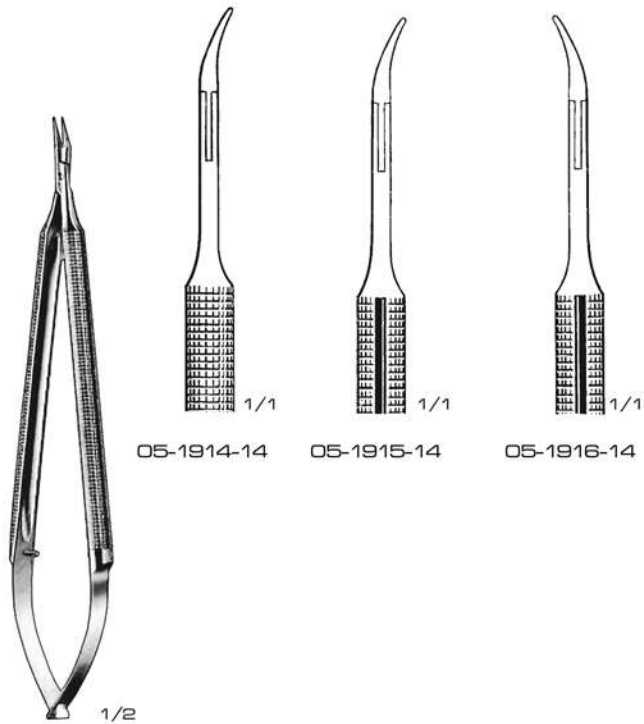

Gomel
14 cm / 5½"

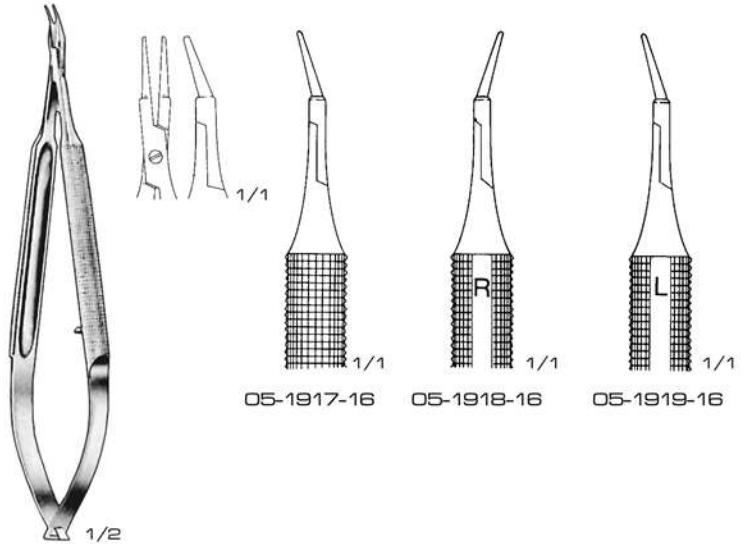

Gomel
16 cm / 6¼"



Jacobson
18.5 cm / 7¼"

1/1
05-1920-185
(with lock)
05-1921-185
(without lock)

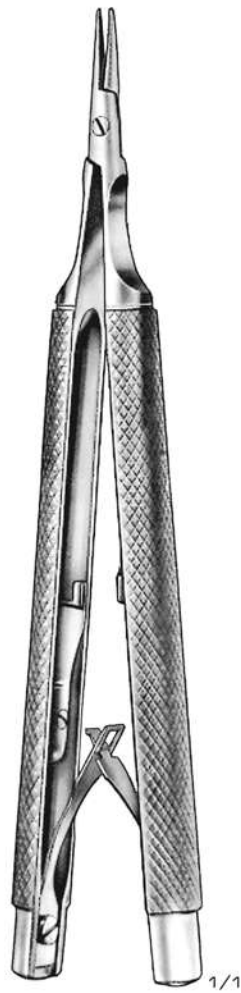

Castroviejo
05-1922-13
13 cm / 5¼"

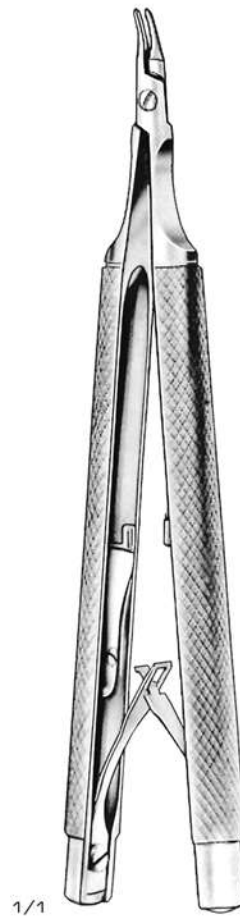

Castroviejo-Baraquer
05-1923-12
12 cm / 4¾"

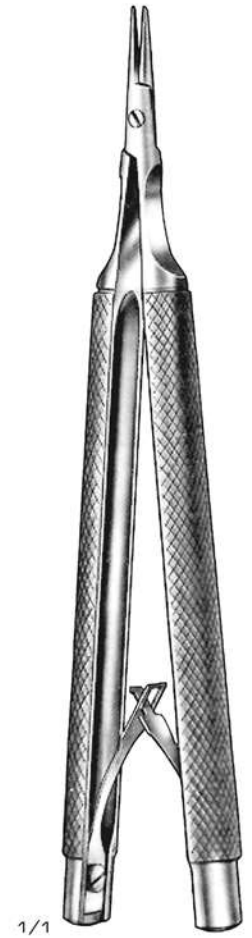

Castroviejo
05-1924-12
12 cm / 4¾"

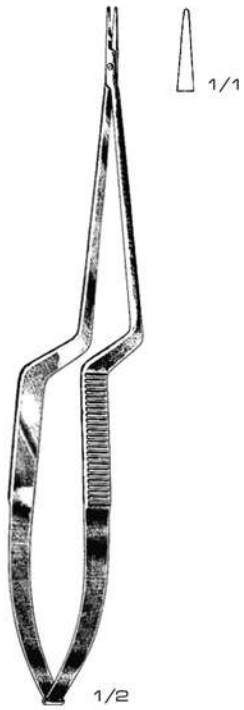

Jacobson
05-1925-185
18.5 cm / 7 1/4"

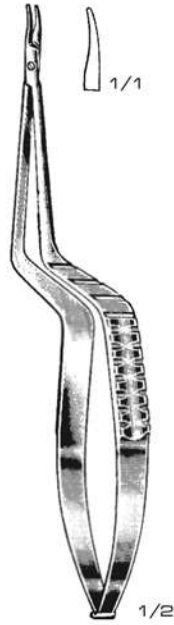

05-1926-16
16 cm / 6 1/4"



Yasargil
20 cm / 8"

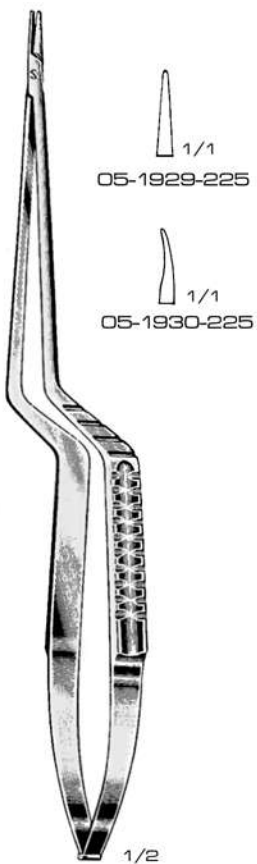

Yasargil
22.5 cm / 8 3/4"



Yasargil
22.5 cm / 8 3/4"



Yasargil
05-1933-245
24.5 cm / 9 3/4"



Hunt
05-1934-22
22 cm / 8³/₄"
Tumor and vessel forceps

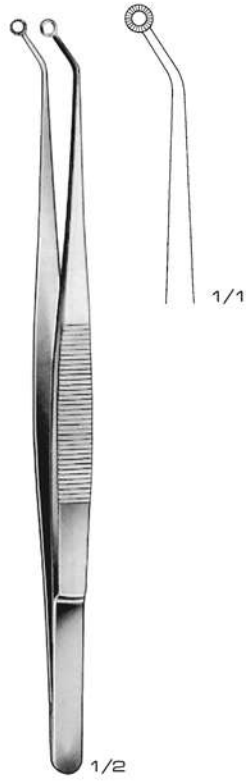

Hunt
05-1935-20
20 cm / 8"
Tumor and vessel forceps

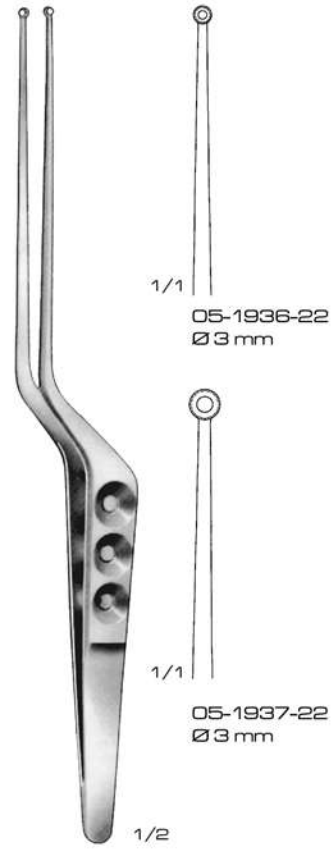

Heifetz
22 cm / 8³/₄"
Tumor and vessel forceps

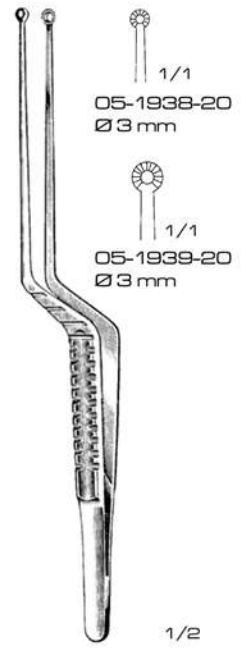

Yasargil
20 cm / 8"
Tumor and vessel forceps



05-1940-20
Ø 3 mm

05-1941-20
Ø 5 mm

Yasargil
20 cm / 8"
Spoon type sharp



05-1942-22
Ø 3 mm

05-1943-22
Ø 5 mm

Yasargil
22 cm / 8³/₄"
Tumor forceps

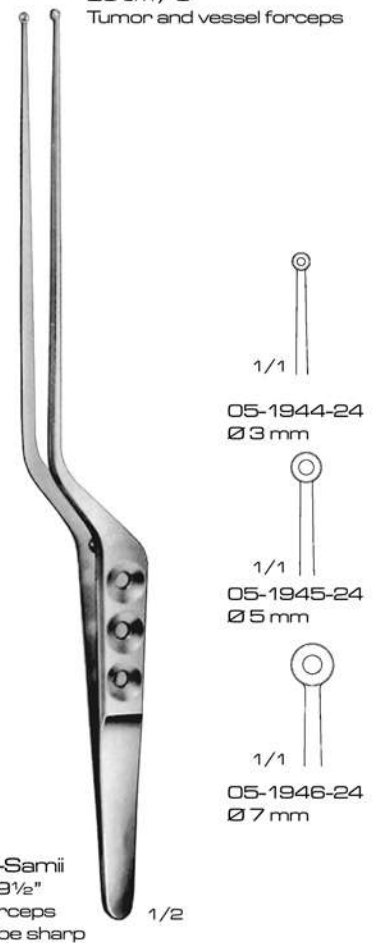

05-1944-24
Ø 3 mm

05-1945-24
Ø 5 mm

05-1946-24
Ø 7 mm

Yasargil-Samii
24 cm / 9¹/₂"
Tumor forceps
Spoon type sharp

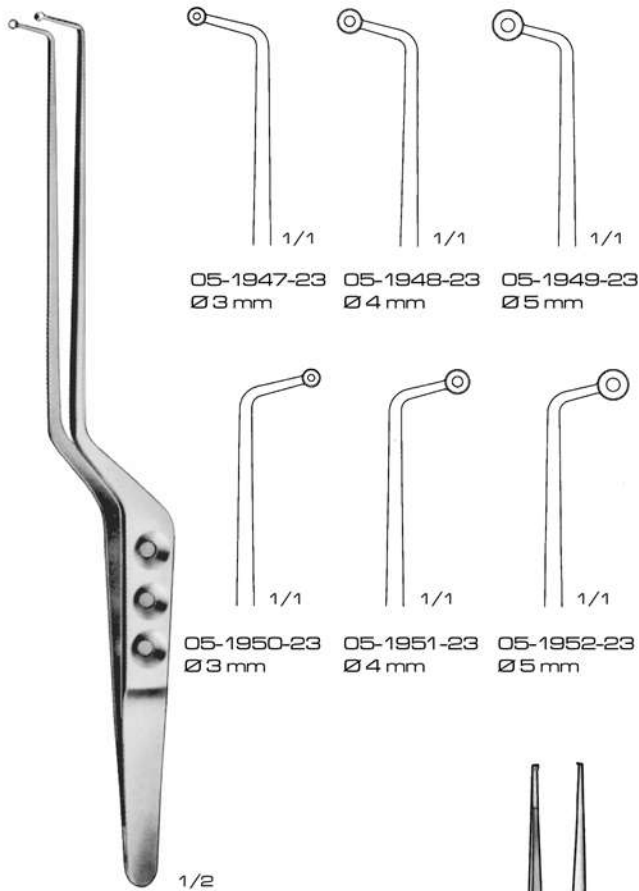

05-1947-23 1/1 Ø3 mm
 05-1948-23 1/1 Ø4 mm
 05-1949-23 1/1 Ø5 mm

05-1950-23 1/1 Ø3 mm
 05-1951-23 1/1 Ø4 mm
 05-1952-23 1/1 Ø5 mm

Samii
 23 cm / 9"
 Tumor Forceps Spoon Type sharp



1/2 De Bakey



05-1953-15 15 cm / 6" 05-1957-15
 05-1954-18 18 cm / 7" 05-1958-18
 05-1955-20 20 cm / 8" 05-1959-20
 05-1956-24 24 cm / 9½" 05-1960-24
 1 mm 1 mm



05-1961-15 15 cm / 6" 05-1965-15
 05-1962-18 18 cm / 7" 05-1966-18
 05-1963-20 20 cm / 8" 05-1967-20
 05-1964-24 24 cm / 9½" 05-1968-24
 1.8 mm 1.8 mm

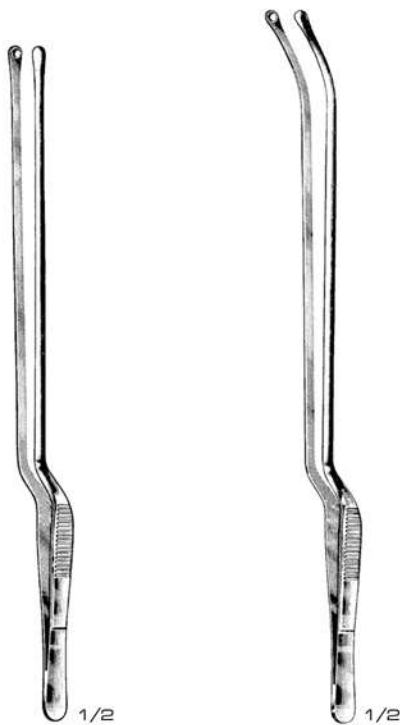

Adson
 05-1969-215
 21.5 cm / 8½"
 Hypophyseal Forceps



Adson
 05-1970-215
 21.5 cm / 8½"
 Hypophyseal Forceps



Tying

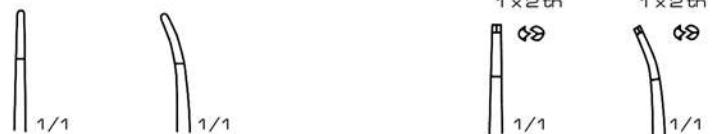

05-1971-15 05-1974-15 15 cm / 6" 05-1977-15 05-1980-15
 05-1972-18 05-1975-18 18 cm / 7" 05-1978-18 05-1981-18
 05-1973-20 05-1976-20 20 cm / 8" 05-1979-20 05-1982-20
 Jaw 0.4 x 6 mm Jaw 0.4 x 6 mm

05-1983-15 05-1986-15 15 cm / 6" 05-1989-15 05-1992-15
 05-1984-18 05-1987-18 18 cm / 7" 05-1990-18 05-1993-18
 05-1985-20 05-1988-20 20 cm / 8" 05-1991-20 05-1994-20
 Jaw 0.8 x 6 mm Jaw 0.8 x 6 mm



05-1995-15 15 cm / 6" 0.4 mm 05-2001-15
 05-1996-15 15 cm / 6" 0.8 mm 05-2002-15
 05-1997-18 18 cm / 7" 0.4 mm 05-2003-18
 05-1998-18 18 cm / 7" 0.8 mm 05-2004-18
 05-1999-20 20 cm / 8" 0.4 mm 05-2005-20
 05-2000-20 20 cm / 8" 0.8 mm 05-2006-20

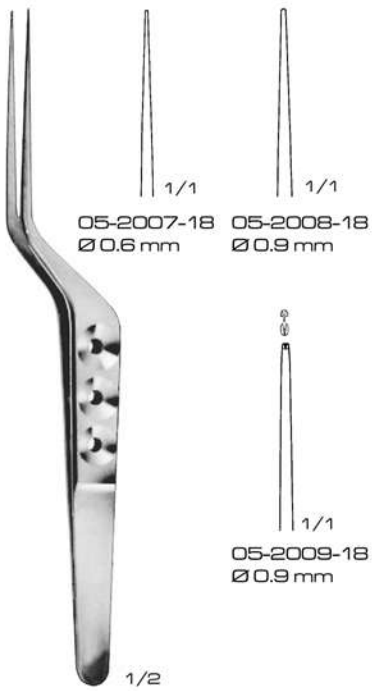

Yasargil
18 cm / 7"

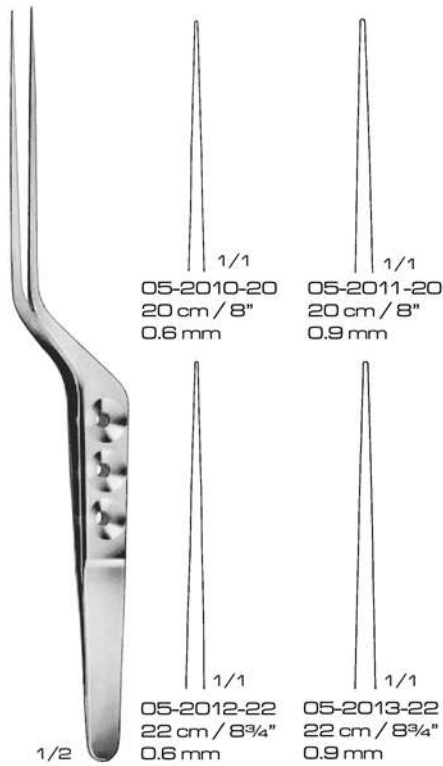

Yasargil

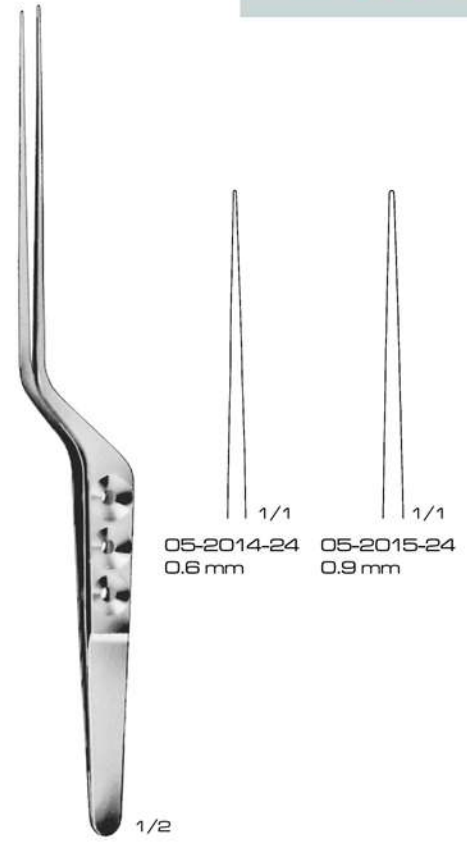

Yasargil
24 cm / 9 1/2"

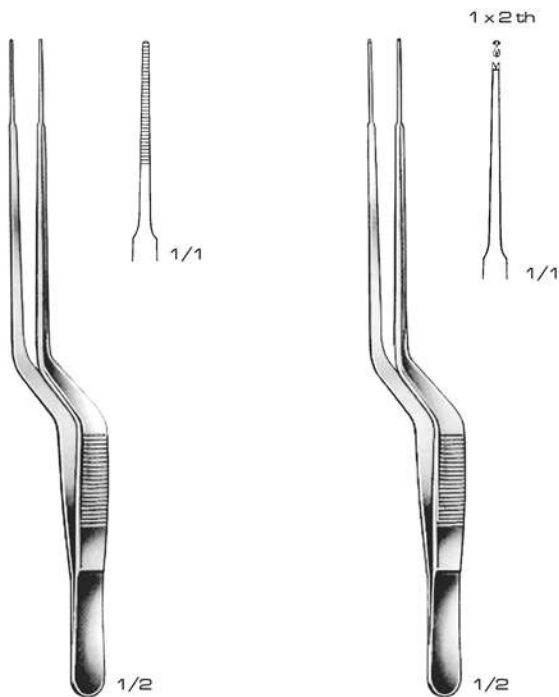

Gerald
05-2016-18
18 cm / 7"

Gerald
05-2017-18
18 cm / 7"



Ring Ø

0.5 x 1.0 mm 05-2018-15 15 cm / 6" 05-2022-15
0.5 x 1.0 mm 05-2019-18 18 cm / 7" 05-2023-18
0.5 x 1.0 mm 05-2020-21 21 cm / 8 1/4" 05-2024-21
0.5 x 1.0 mm 05-2021-24 24 cm / 9 1/2" 05-2025-24



Ring Ø

1.5 x 2.0 mm 05-2026-15 15 cm / 6" 05-2030-15
1.5 x 2.0 mm 05-2027-18 18 cm / 7" 05-2031-18
1.5 x 2.0 mm 05-2028-21 21 cm / 8 1/4" 05-2032-21
1.5 x 2.0 mm 05-2029-24 24 cm / 9 1/2" 05-2033-24



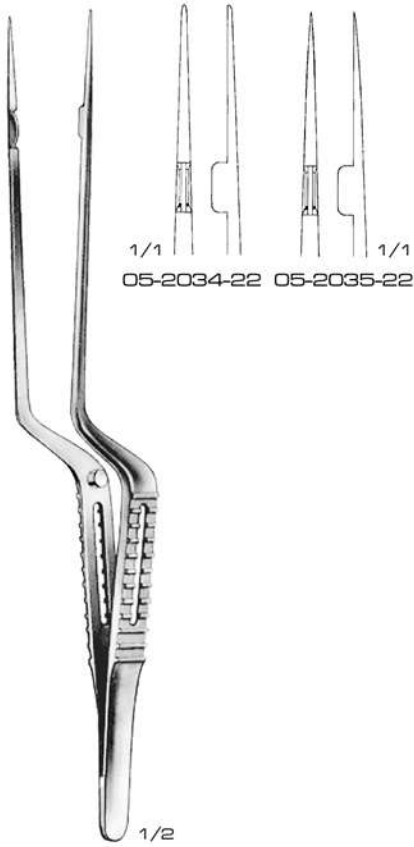

22 cm / 8³/₄"

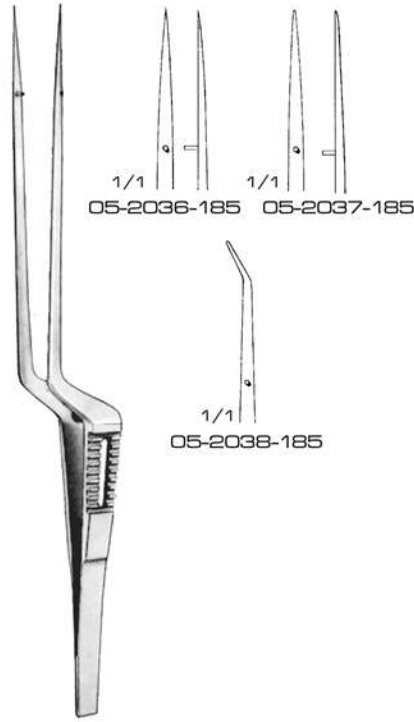

18.5 cm / 7¹/₄"



Jacobson-Adson
05-2039-12
12 cm / 4³/₄"

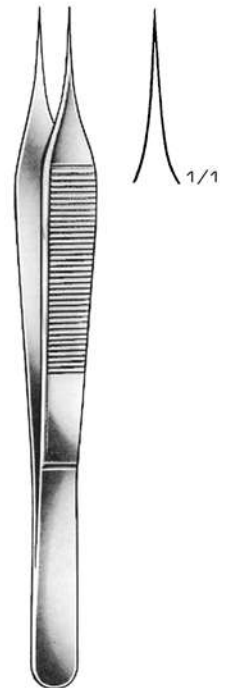

Jacobson-Adson
05-2040-15
15 cm / 6"

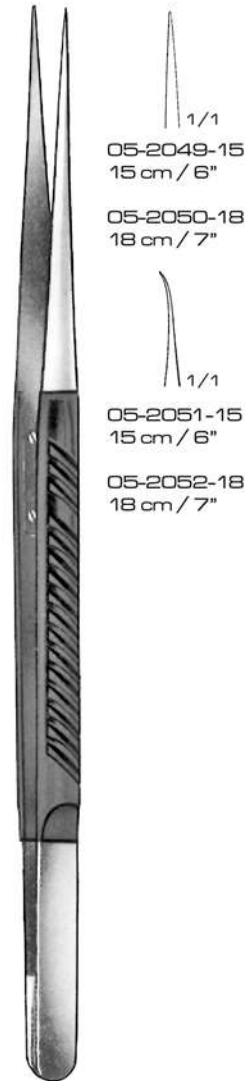
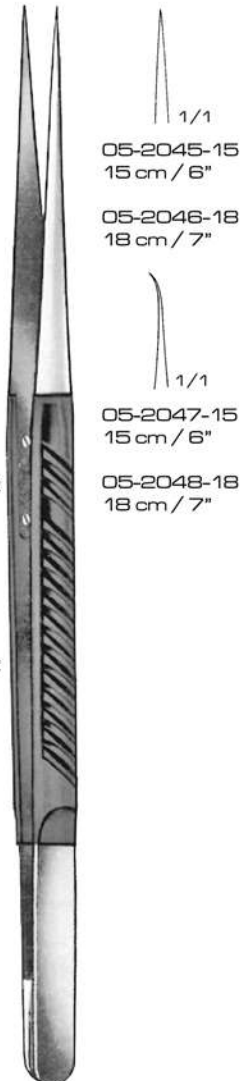
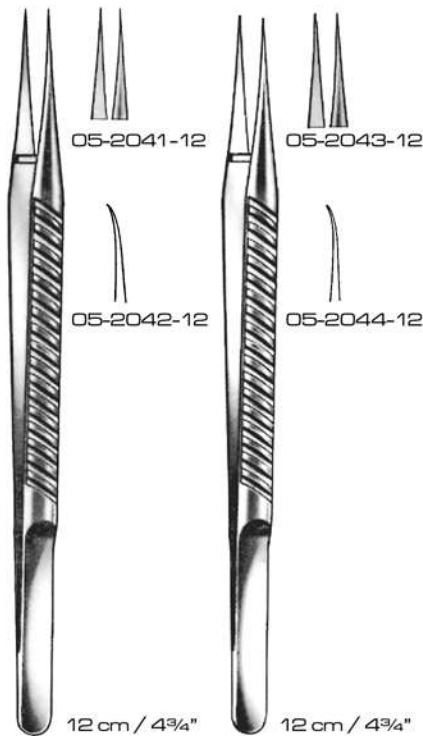

Also Available in 18/8 Steel



05-2055-10
10 cm / 4"



05-2056-10
10 cm / 4"



05-2057-10
10 cm / 4"



05-2058-14
14 cm / 5½"



05-2059-14
14 cm / 5½"



05-2060-105
10.5 cm / 4¼"



05-2061-105
10.5 cm / 4¼"



05-2062-115
11.5 cm / 4½"



05-2063-115
11.5 cm / 4½"



05-2064-105
10.5 cm / 4¼"



05-2065-105
10.5 cm / 4¼"



05-2066-105
10.5 cm / 4¼"



Jacobson
 05-2067-11 11 cm / 4¼"
 05-2068-15 15 cm / 6"
 05-2069-18 18 cm / 7"

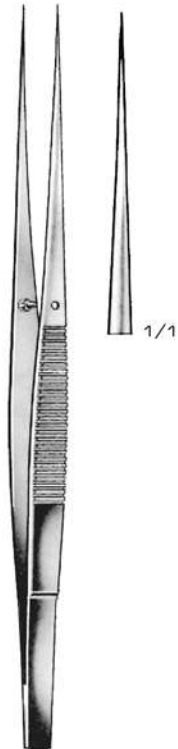

05-2070-195
 19.5 cm / 7¾"

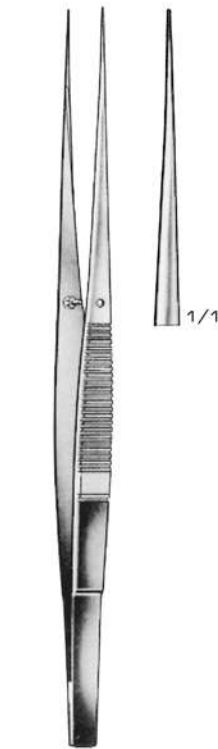

05-2071-195
 19.5 cm / 7¾"



05-2072-195
 19.5 cm / 7¾"



05-2073-195
 19.5 cm / 7¾"



05-2074-195
 19.5 cm / 7¾"



05-2075-19
 19 cm / 7½"

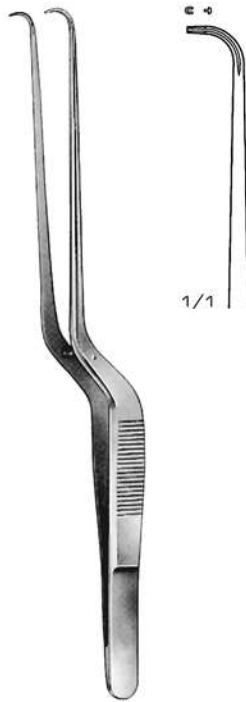

Yasargil
 05-2076-185
 18.5 cm / 7¼"

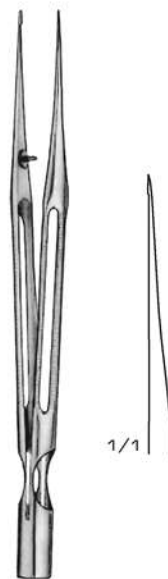

Brock
 05-2077-15
 15 cm / 6"

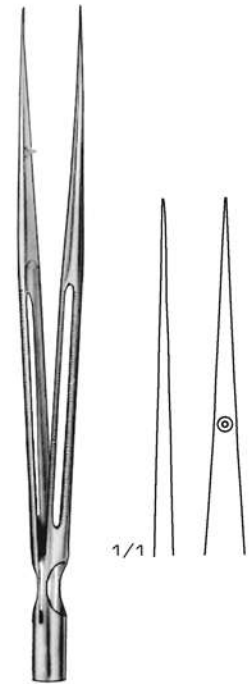

Brock
 05-2078-18
 18 cm / 7"

Rib Shears, Spreaders & Contractors



OGE
ORTHOGENT
ENGINEERING



Collin
05-2079-195
19.5 cm / 7¾"

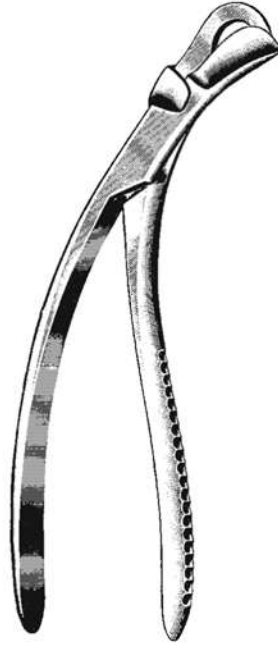

Collin
05-2080-17
17 cm / 6¾"



Gluck
05-2081-16 16 cm / 6¼"
05-2082-18 18 cm / 7"
05-2083-20 20 cm / 8"
05-2084-23 23 cm / 9"



Stille
05-2085-21
21 cm / 8¼"



05-2086-23
23 cm / 9"



05-2087-22
22 cm / 8¾"



Schuchardt
05-2088-17 17 cm / 6¾"
05-2089-23 23 cm / 9"

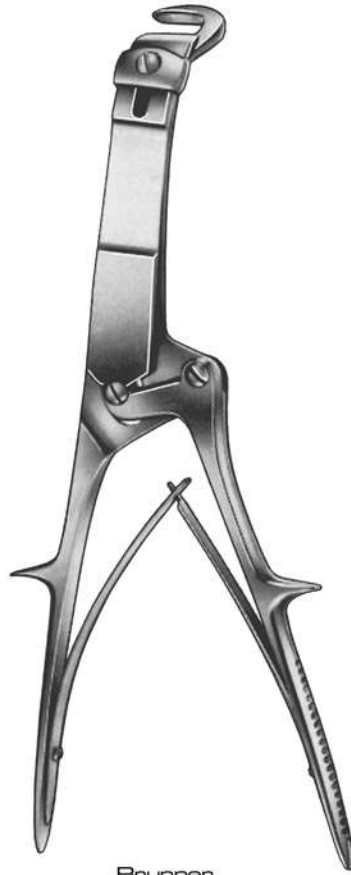

Brunner
05-2090-34
34 cm / 13½"



Sauerbruch-Frey
05-2091-36
36 cm / 14"



Giertz-Stille
05-2092-25
25 cm / 10"



Lebsche
05-2093-25
25 cm / 10"



Sauerbruch
05-2094-23 23 cm / 9"
05-2095-26 26 cm / 10¼"



Baer

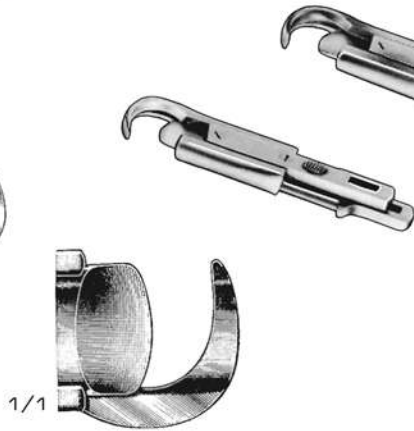

Sauerbrush-Britsch
05-2098-30
30 cm / 12"
with 2 exchangeable
cutterheads

05-2096-19
19 cm / 7½"

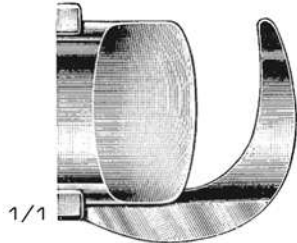

05-2097-23
23 cm / 9"



Schumacher
05-2099-21
21 cm / 8¼"

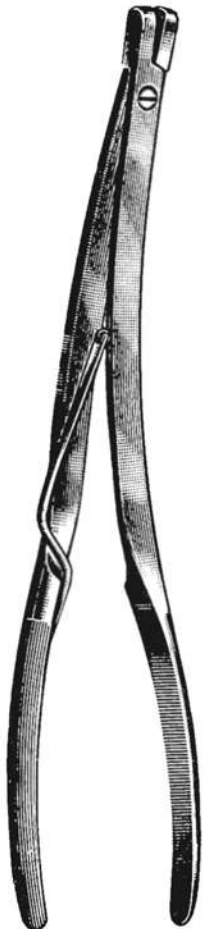

Lebsche
05-2100-33
33 cm / 13"



Coryllos-Bethune (Collin)
05-2101-30 Left
30 cm / 12"



05-2102-30
Right

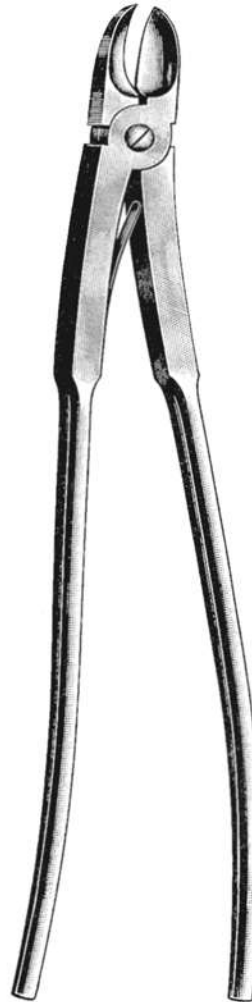

Bethune
05-2103-34
34 cm / 13½"



Lebsche
05-2104-25
25 cm / 10"

RIB SPREADERS



All available in Aluminium as well.



05-2105-12
Opening 12 cm / 4³/₄"
Blades 28 x 32 mm



Morse
05-2106-20 For Children
With moveable double blades
Opening 20 cm / 8"
Blades 12 x 20 mm

05-2107-20 For Adults
With moveable double blades
Opening 20 cm / 8"
Blades 19 x 19 mm

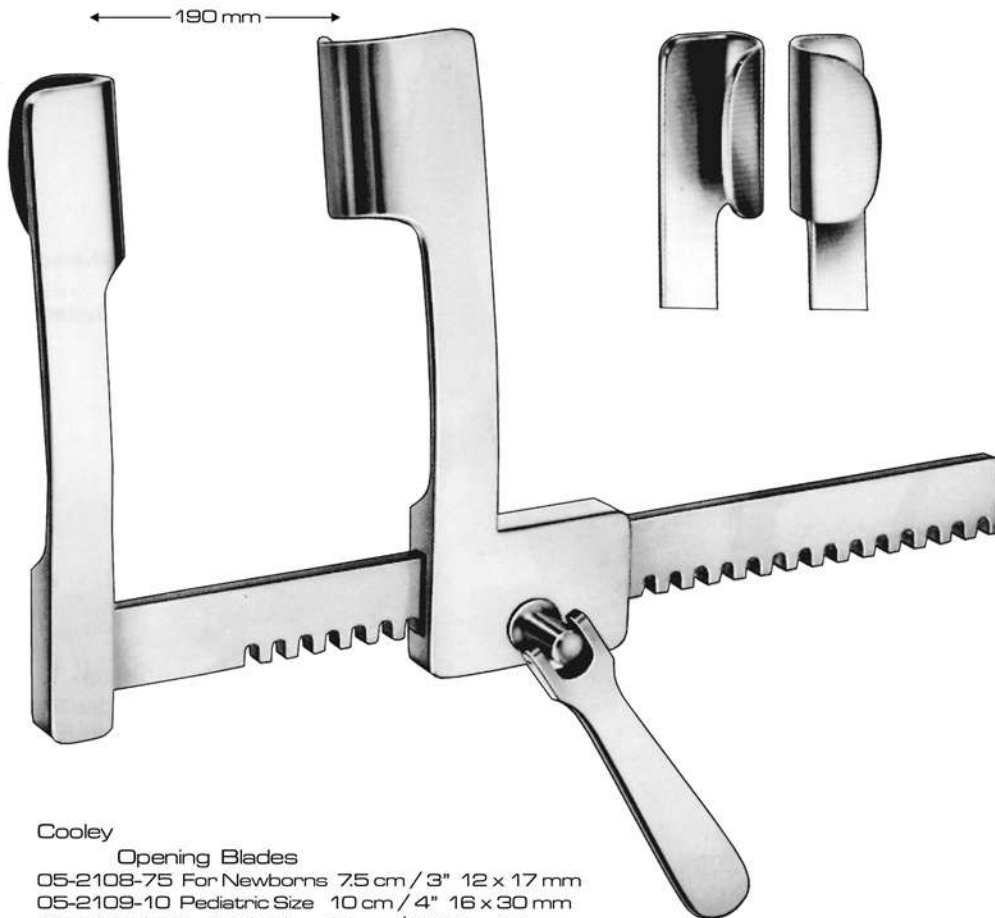

Cooley
Opening Blades
05-2108-75 For Newborns 7.5 cm / 3" 12 x 17 mm
05-2109-10 Pediatric Size 10 cm / 4" 16 x 30 mm
05-2110-15 Pediatric Size 15 cm / 6" 21 x 44 mm
05-2111-20 For Adults 20 cm / 8" 37 x 49 mm

All available in Aluminium as well.

← 75 mm →



Struck
05-2112-75
Opening 7.5 cm / 3"
For infants



05-2113-00
Blades 10 x 10 mm



05-2114-00
Blades 10 x 15 mm



05-2115-00
Blades 10 x 20 mm



05-2116-00
Blades 15 x 20 mm



05-2117-00
Blades 20 x 20 mm

← 115 mm →

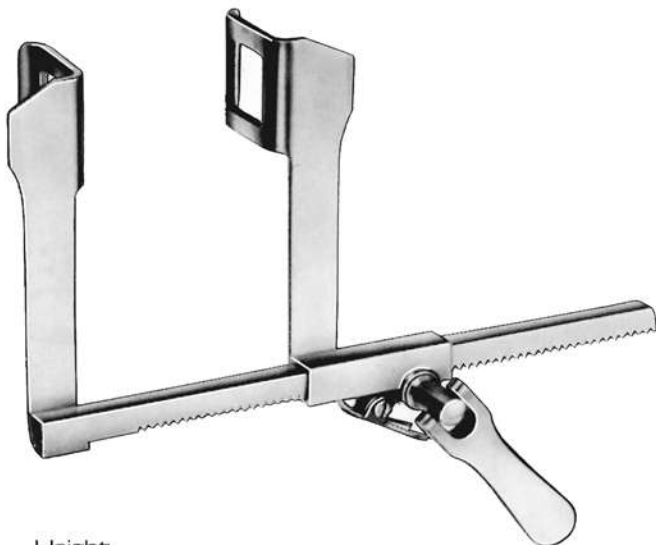

Haight
05-2118-09
Opening 9 cm / 3½"
Blades 30 x 30 mm

05-2119-115
Opening 11.5 cm / 4½"
Blades 30 x 30 mm

← 75 mm →

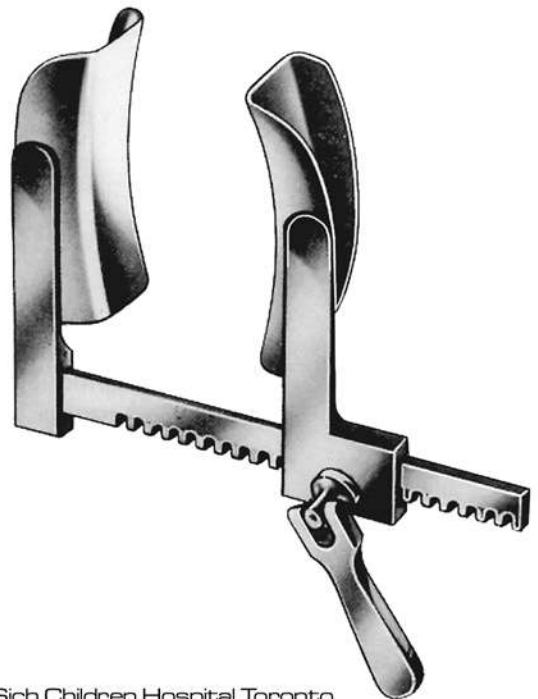

Sich Children Hospital Toronto
For Infants
05-2120-75
Opening 7.5 cm / 3"
Blades 20 x 40 mm

05-2121-75
Opening 7.5 cm / 3"
Blades 20 x 60 mm

RIB SPREADERS



All available in Aluminium as well.

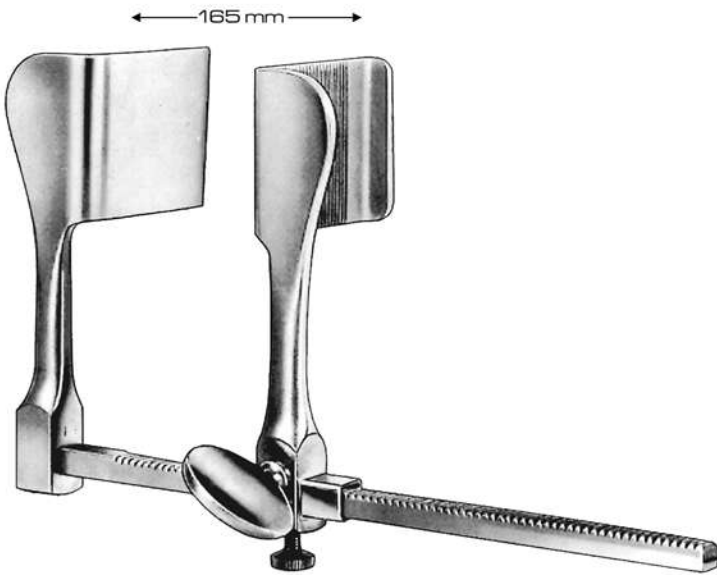

Tuffier
 05-2122-13 Opening 13 cm / 5"
 05-2123-15 Opening 15 cm / 6"
 05-2124-165 Opening 16.5 cm / 6½"
 Blades 50 x 45 mm

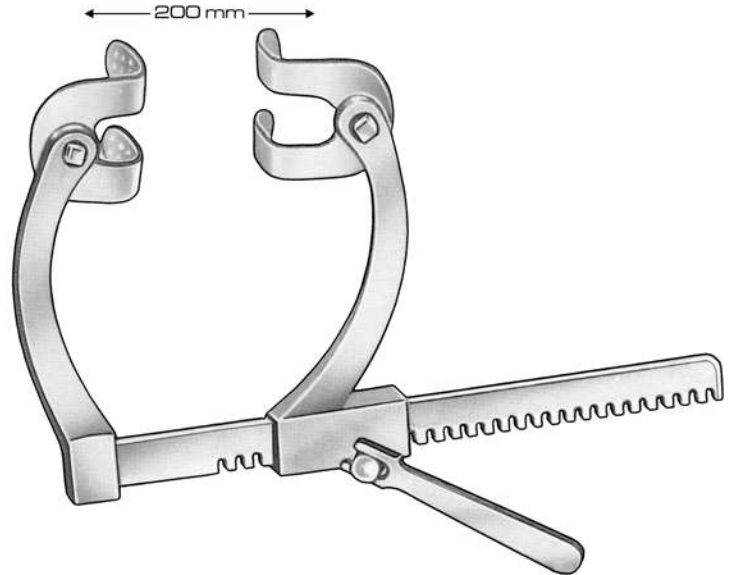

Sellors
 05-2125-20 Opening 20 cm / 8"
 Blades 38 x 50 mm



Finochietto
 05-2126-14 14 cm / 4¼" 36 x 45 mm
 05-2127-165 16.5 cm / 6½" 40 x 40 mm
 05-2128-21 21 cm / 8¼" 44 x 65 mm
 05-2129-21 21 cm / 8¼" 65 x 65 mm
 05-2130-25 25 cm / 10" 70 x 65 mm
 05-2131-30 30 cm / 12" 70 x 65 mm

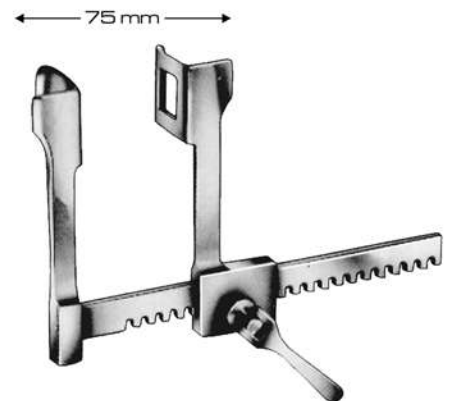

Finochietto
 05-2132-75
 Opening 7.5 cm / 3"
 Blades 18 x 21 mm

All available in Aluminium as well.

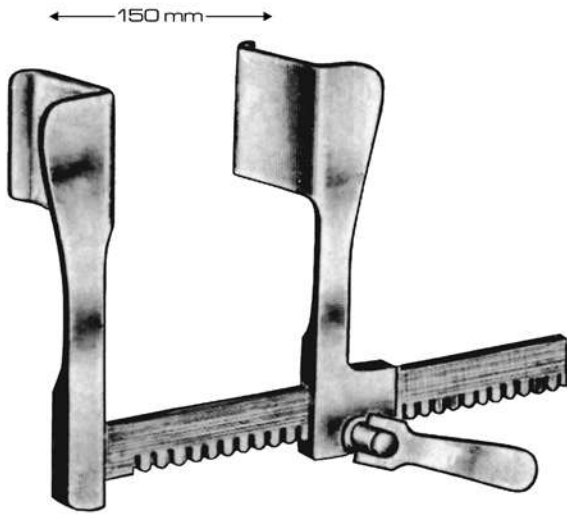

Reinhold-Finochietto
Opening Blades
05-2133-15 15 cm / 6" 25 x 20 mm
05-2134-15 15 cm / 6" 38 x 32 mm
05-2135-15 15 cm / 6" 48 x 45 mm

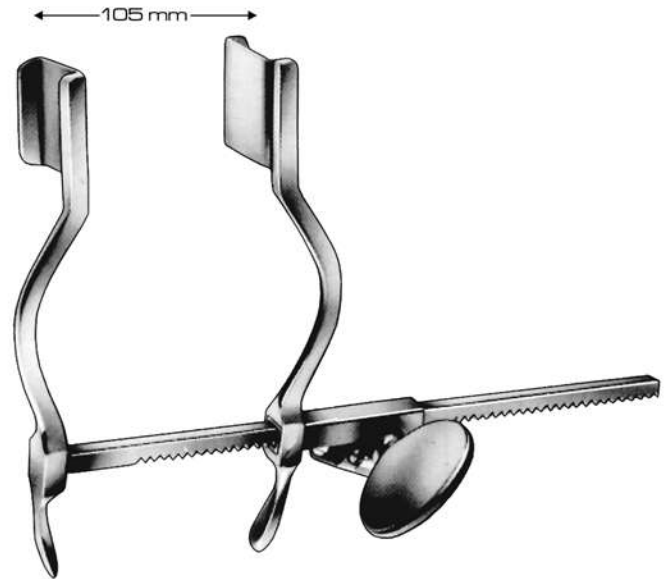

Hertzier
Opening Blades
05-2136-75 7.5 cm / 3" 25 x 20 mm
05-2137-95 9.5 cm / 3 3/4" 38 x 32 mm
05-2138-105 10.5 cm / 4 1/4" 48 x 45 mm

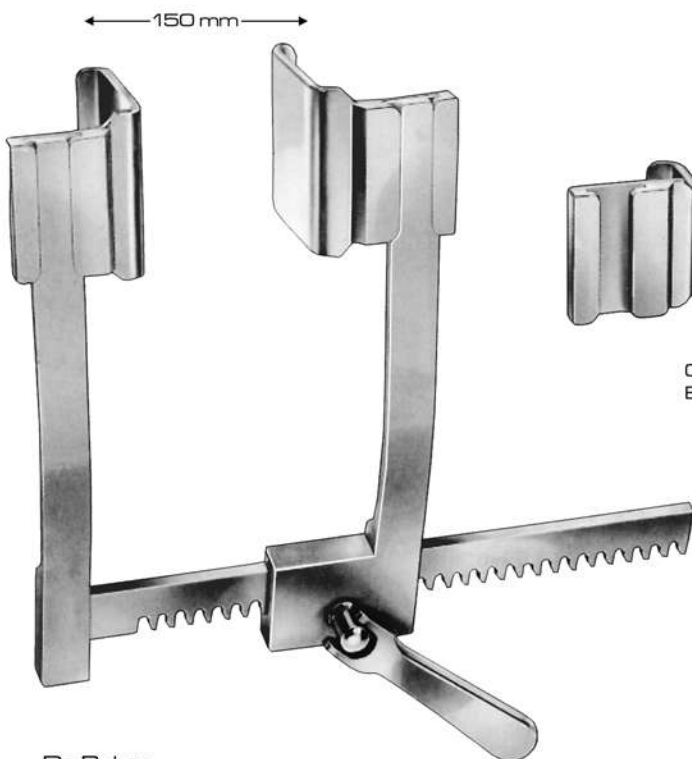

De Bakey
05-2139-15
Opening 15cm / 6"
05-2143-15
With 3 pairs of interchangeable blades:
05-2140-00
05-2141-00
05-2142-00



05-2140-00
Blades 30 x 30 mm



05-2141-00
Blades 40 x 40 mm



05-2142-00
Blades 50 x 50 mm



All available in Aluminium as well.

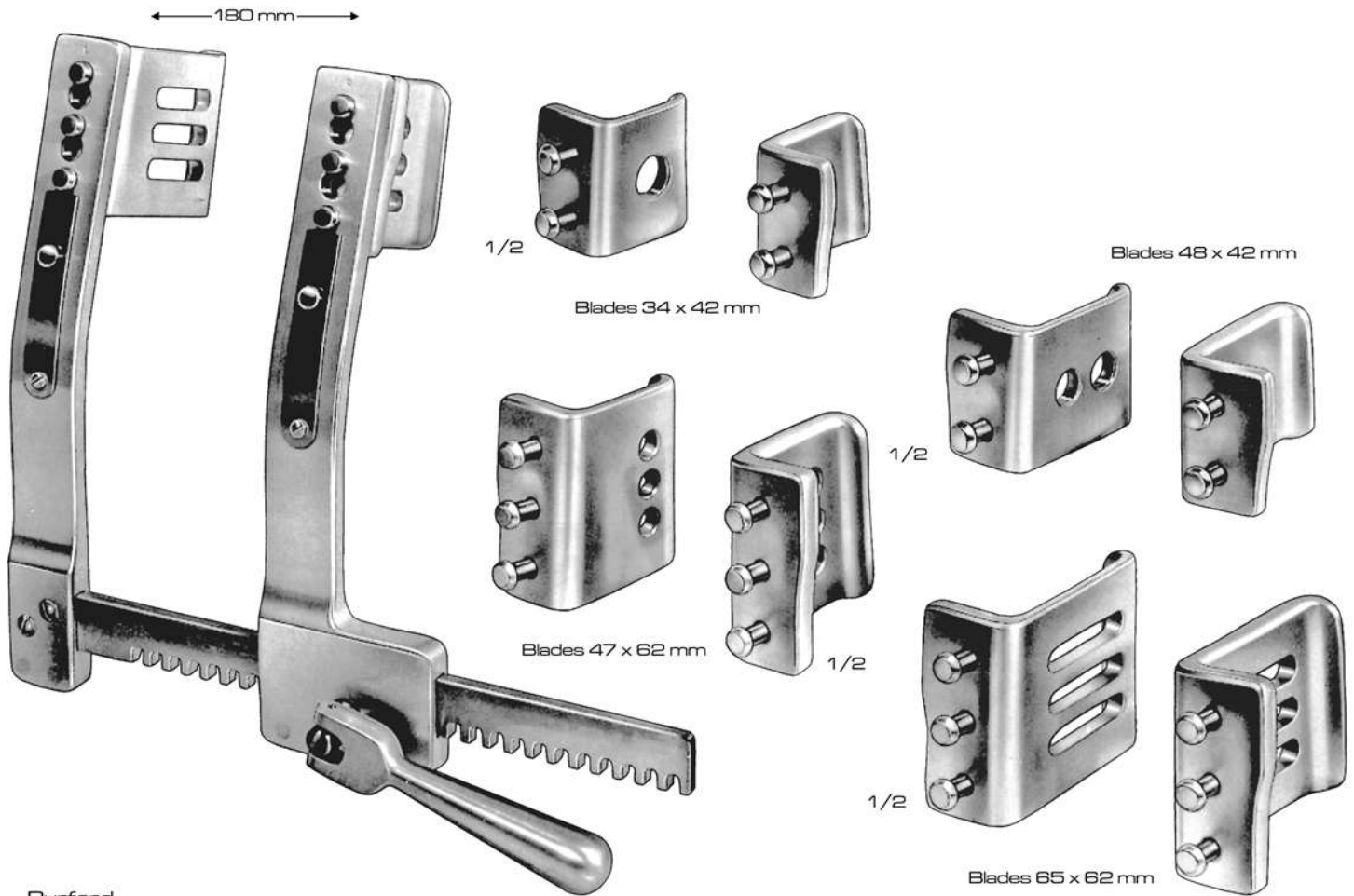
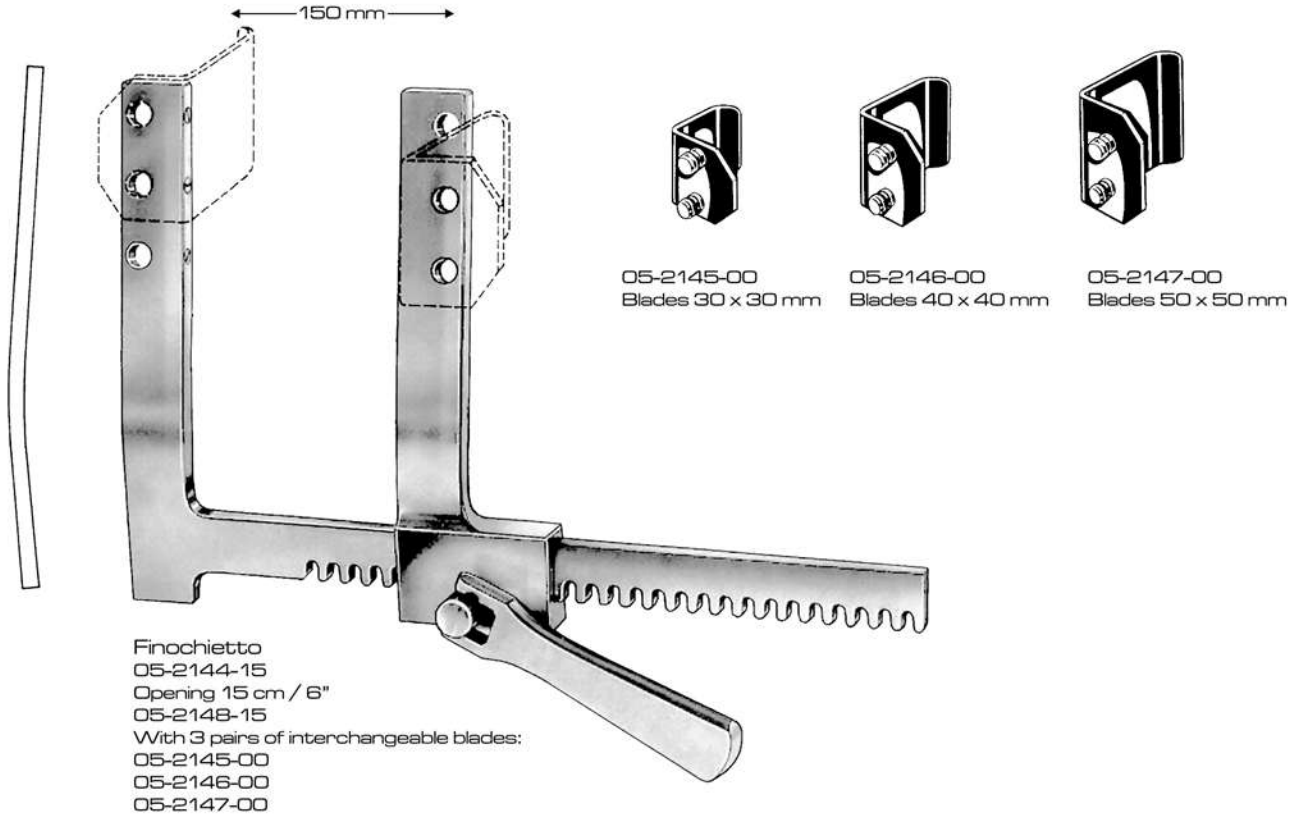

Burford
Opening Blades
For Infants: 05-2149-135 13.5 cm / 5 1/4" 34 x 42 mm & 48 x 42 mm
For Adults: 05-2150-18 18 cm / 7" 47 x 62 mm & 65 x 62 mm
For Adults: 05-2151-26 26 cm / 10 1/4" 47 x 62 mm & 65 x 62 mm
For Adults: 05-2152-30 30 cm / 12" 47 x 62 mm & 65 x 62 mm

All available in Aluminium as well.

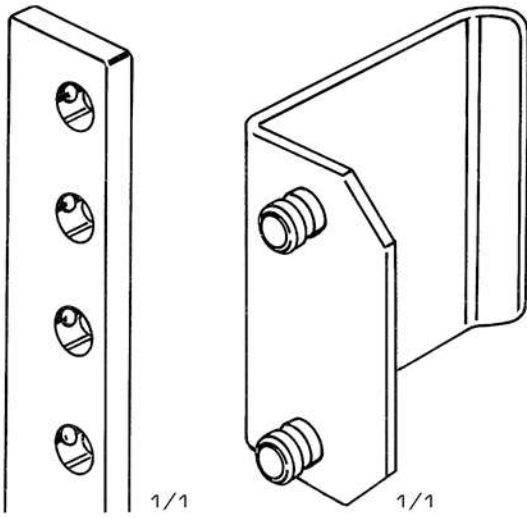

250 mm



05-2154-00
Blades 60 x 60 mm



05-2155-00
Blades 50 x 80 mm



05-2156-00
Blades 40 x 100 mm

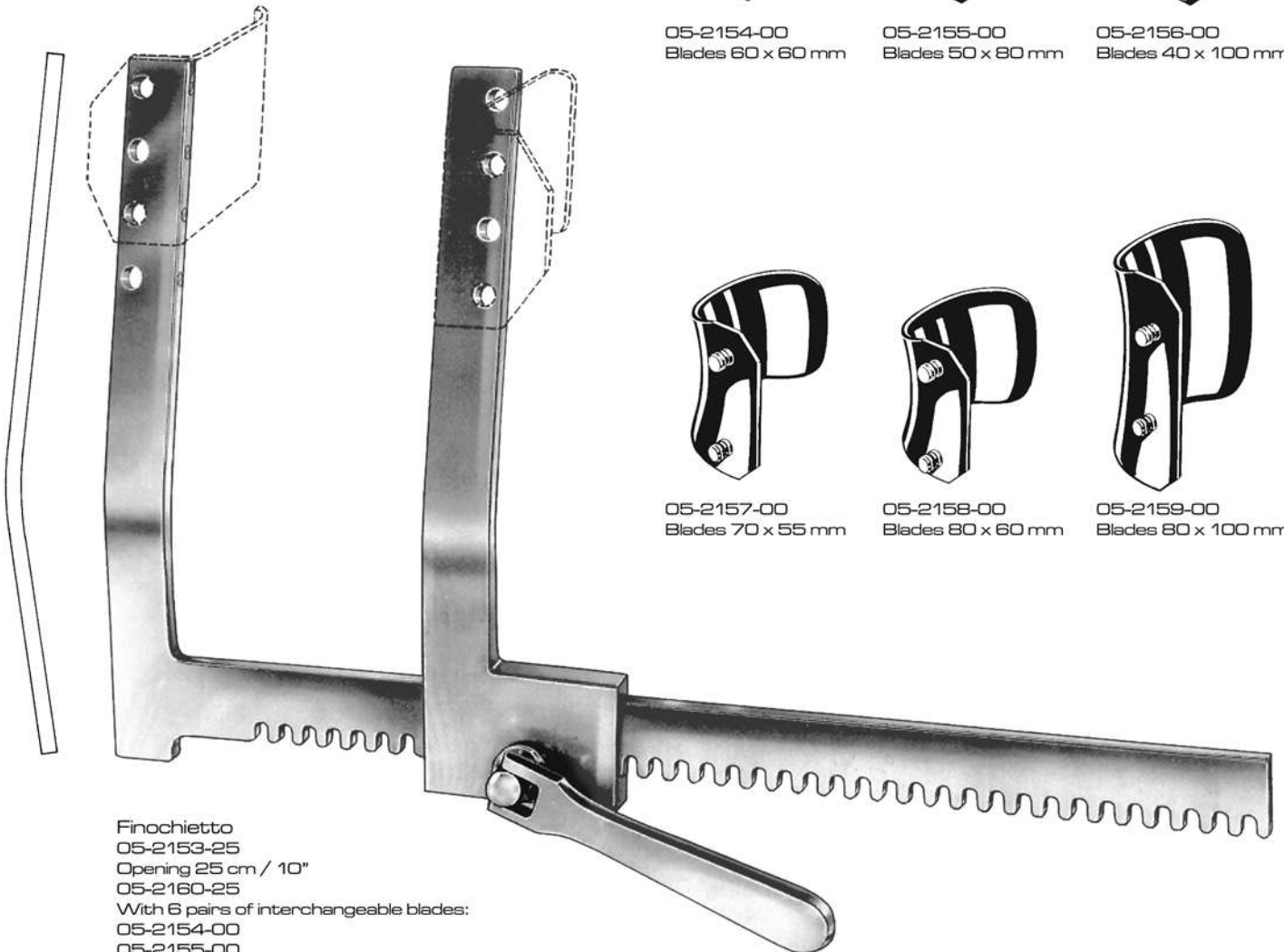

05-2157-00
Blades 70 x 55 mm



05-2158-00
Blades 80 x 60 mm



05-2159-00
Blades 80 x 100 mm

Finochietto
05-2153-25
Opening 25 cm / 10"
05-2160-25
With 6 pairs of interchangeable blades:
05-2154-00
05-2155-00
05-2156-00
05-2157-00
05-2158-00
05-2159-00

RIB SPREADERS



All available in Aluminium as well.

← 200 mm →



Cooley
Opening Blades
05-2160-75 For newborns 7.5 cm / 3" 12 x 17 mm
05-2161-10 pediatric size 10 cm / 4" 16 x 30 mm
05-2162-15 pediatric size 15 cm / 6" 21 x 44 mm
05-2163-20 For adults 20 cm / 8" 37 x 49 mm

← 75 mm →

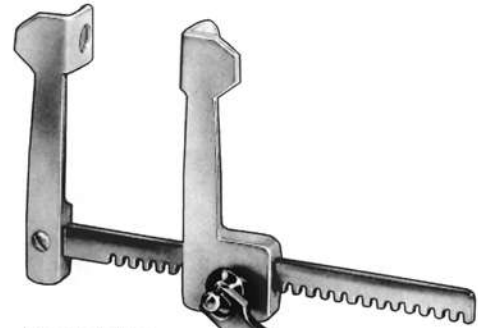

Finochietto
05-2164-75
Opening 7.5 cm / 3"
Blades 15 x 15 mm
For infants

← 210 mm →

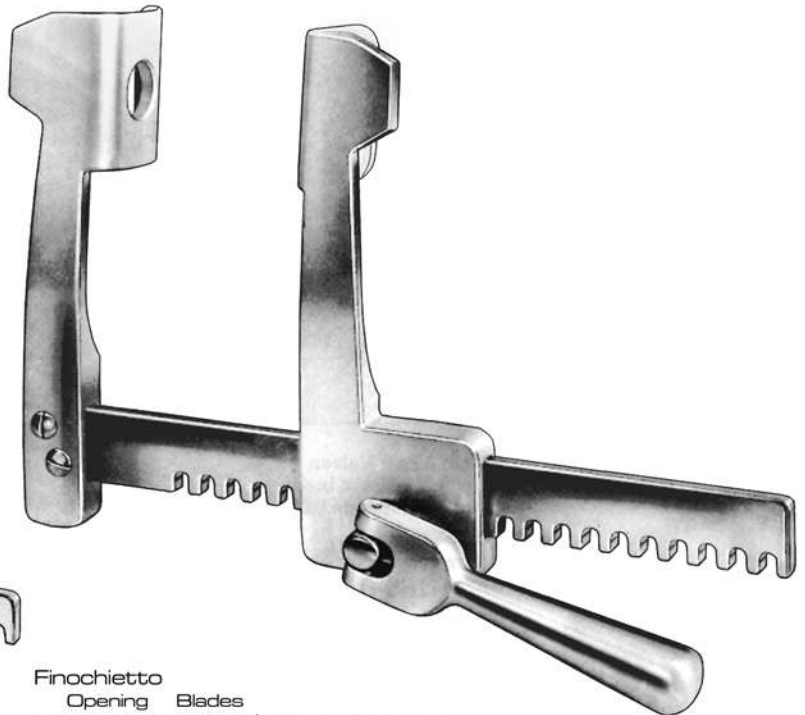

Finochietto
Opening Blades
05-2166-14 14 cm / 5½" 36 x 45 mm
05-2167-165 16.5 cm / 6½" 40 x 40 mm
05-2168-21 21 cm / 8¼" 44 x 65 mm
05-2169-21 21 cm / 8¼" 65 x 65 mm
05-2170-25 25 cm / 10" 70 x 65 mm
05-2171-30 30 cm / 12" 70 x 65 mm

← 100 mm →

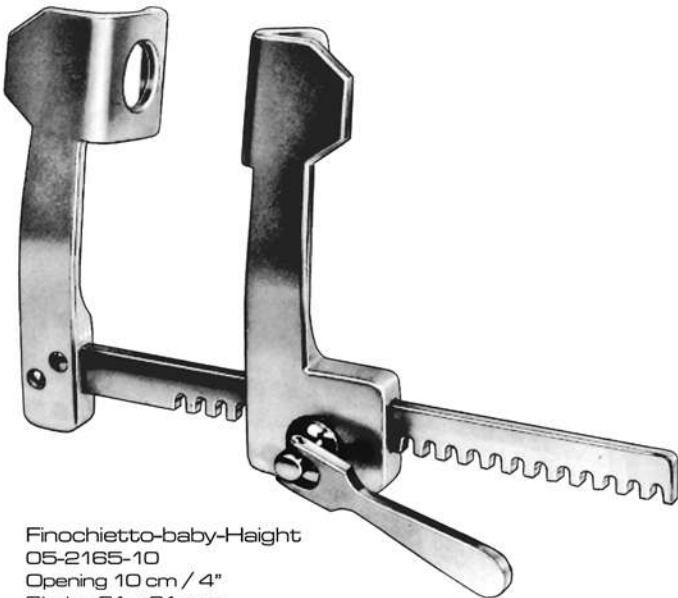

Finochietto-baby-Haight
05-2165-10
Opening 10 cm / 4"
Blades 31 x 31 mm
For children

All available in Aluminium as well.



Ankeney
05-2172-18
Opening 18 cm / 7"
Blades 33 x 35 mm



Castaneda
Opening Blades
05-2173-65 6.5 cm / 2½" 10 x 32 mm
05-2174-07 7 cm / 2¾" 12 x 45 mm
05-2175-12 12 cm / 4¾" 15 x 60 mm



Finochietto
05-2176-12
Opening 12 cm / 4¾"
Blades 14 x 14 mm

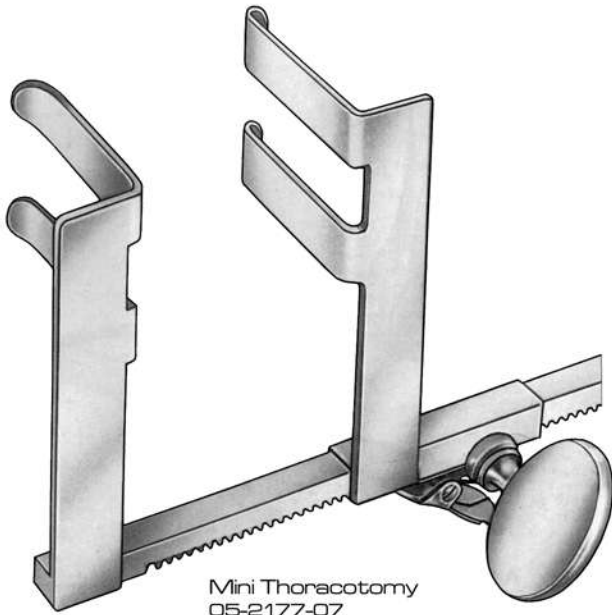

Mini Thoracotomy
05-2177-07
Opening 7 cm / 2¾"
Blades 38 x 12 mm

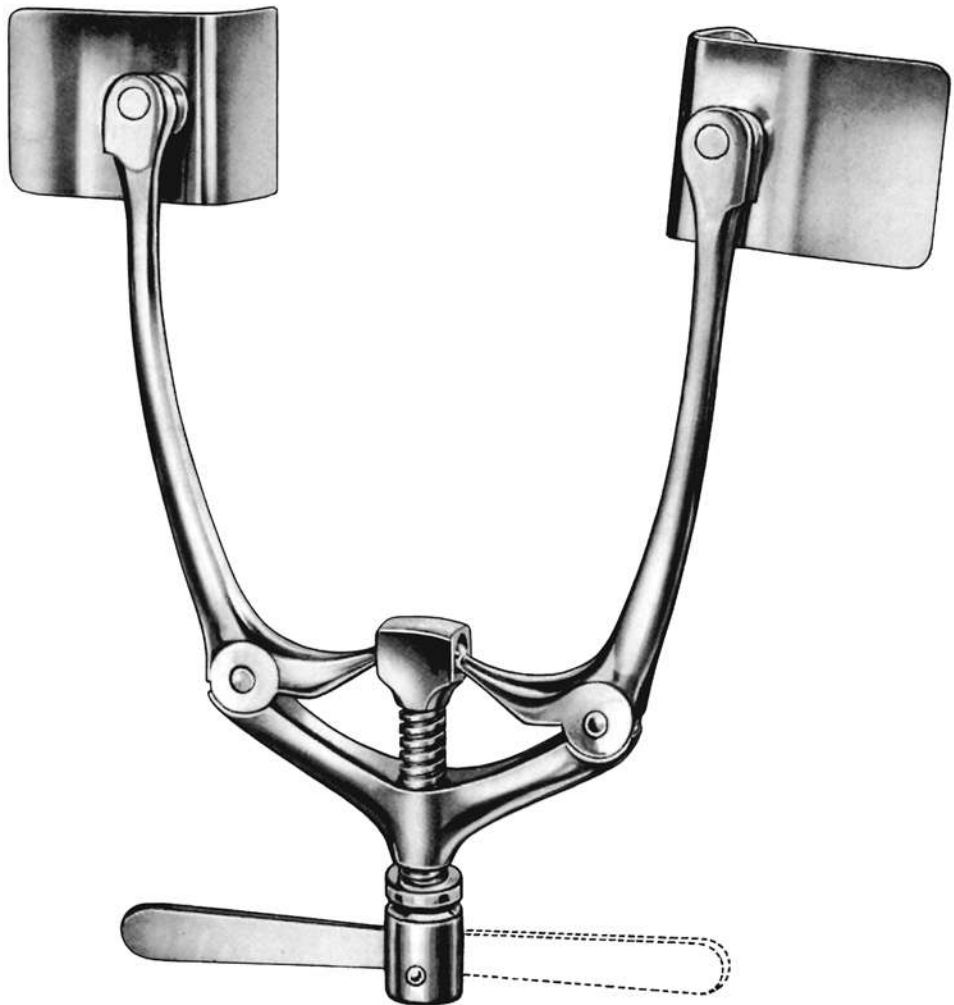

Guervain
05-2178-18
Opening 18 cm / 7"
Blades 35 x 50 mm



Blades 75 x 75 mm



Blades 42 x 65 mm

Thoracic retractor (Mercedes retractor)
 05-2179-24
 Complete Consisting:
 1 Retractor Opening 24 cm / 9½"
 1 Pair of blades 42 x 65 mm
 1 Pair of blades 75 x 75 mm

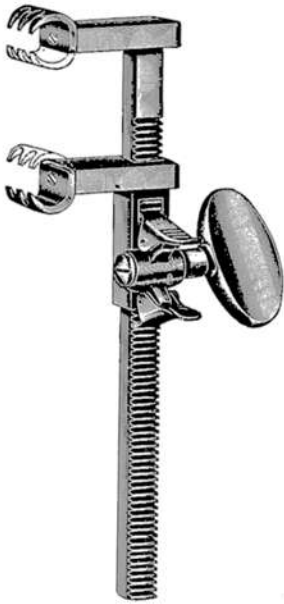

05-2180-17
17 cm / 6¾"



Lemmon
05-2181-145 14.5 cm / 5¾"
05-2182-18 18 cm / 7"



Bailey-Baby
05-2183-14
14 cm / 5½"



Crawford
05-2184-28
28 cm / 11"



05-2186-20



Bailey
20 cm / 8"



05-2185-20

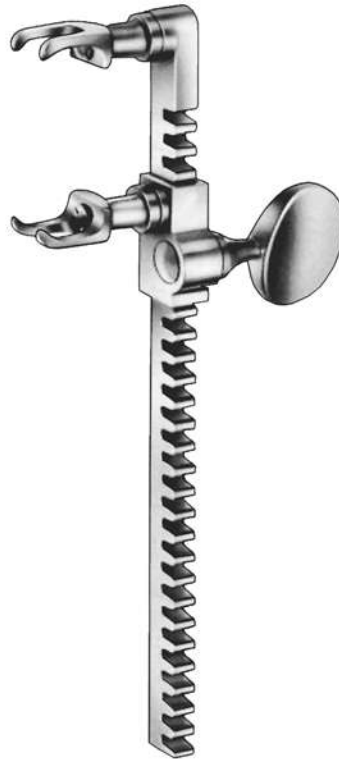

Sellors
05-2187-20
20 cm / 8"

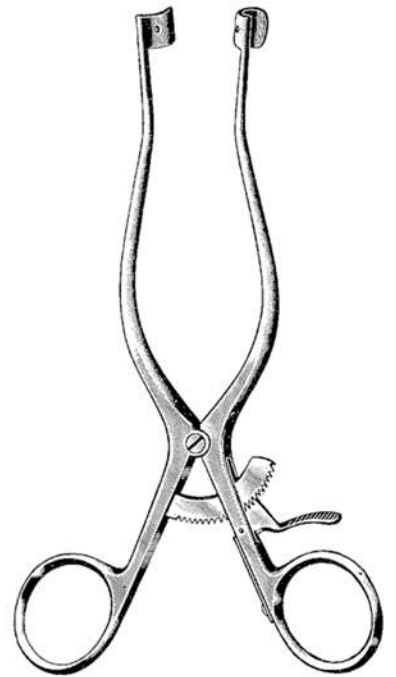

Rehbein (Mod. Bremon)
05-2188-17
17 cm / 6¾"

General Abdominal Surgery & Gynecology



OGE
ORTHOGENT
ENGINEERING



Dennis-Browne
05-2189-19
19 cm / 7½"

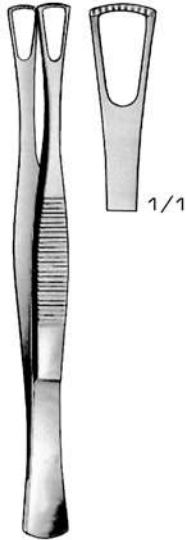

Duval
05-2190-14
14cm / 5½"

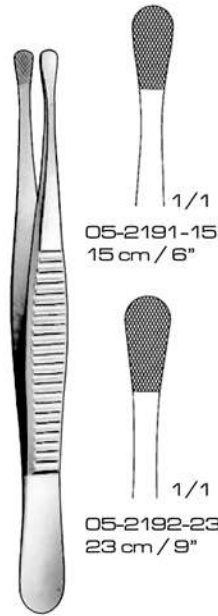

Wangensteen



Stille-Barraya

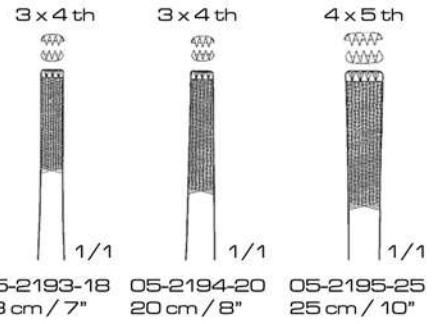

05-2193-18 18 cm / 7"
05-2194-20 20 cm / 8"
05-2195-25 25 cm / 10"

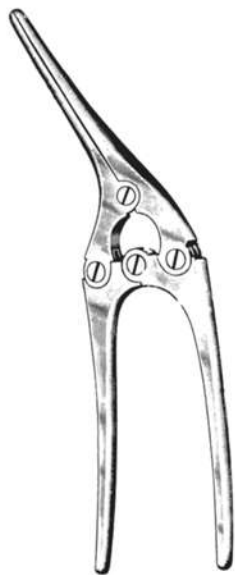

Baby Payr
05-2196-15 15 cm / 6"
05-2197-18 18 cm / 7"



1/1



Payr
05-2198-21
21 cm / 8¼"



1/1

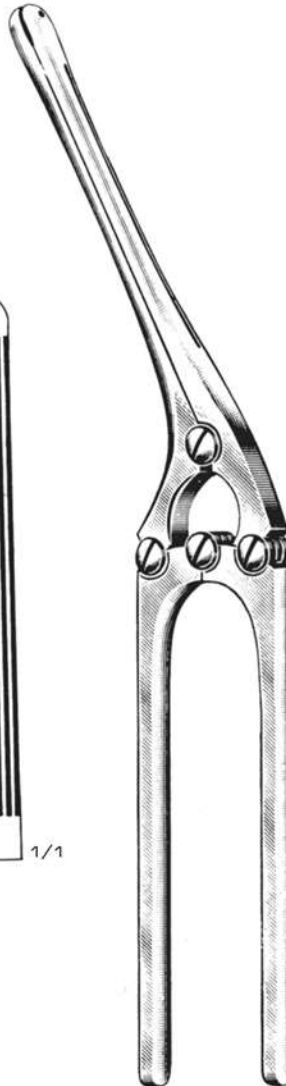

Payr

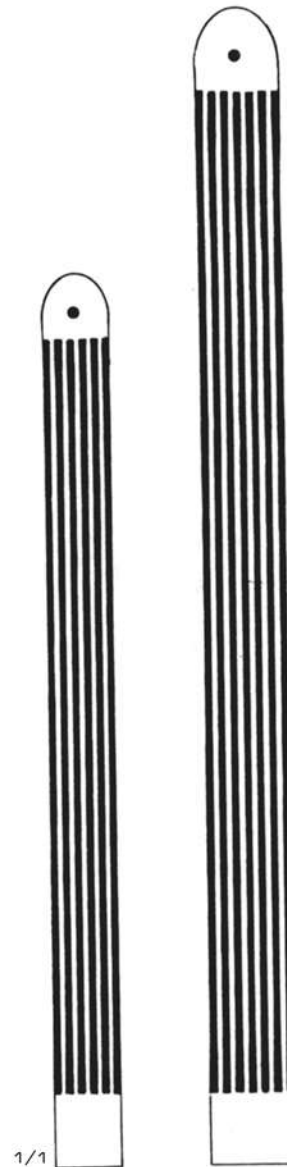

05-2199-29 29 cm / 11½"
05-2200-35 35 cm / 13¾"



22 x 70 mm



Barr
05-2209-17
17 cm / 6³/₄"

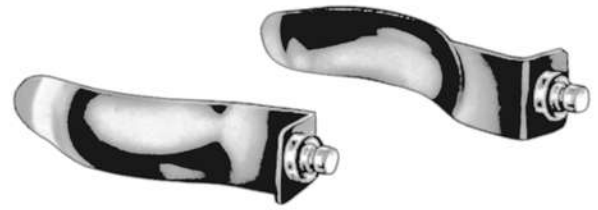

Barr
05-2210-135
13.5 cm / 5¹/₄"
With 2 pairs of blades

23 x 75 mm

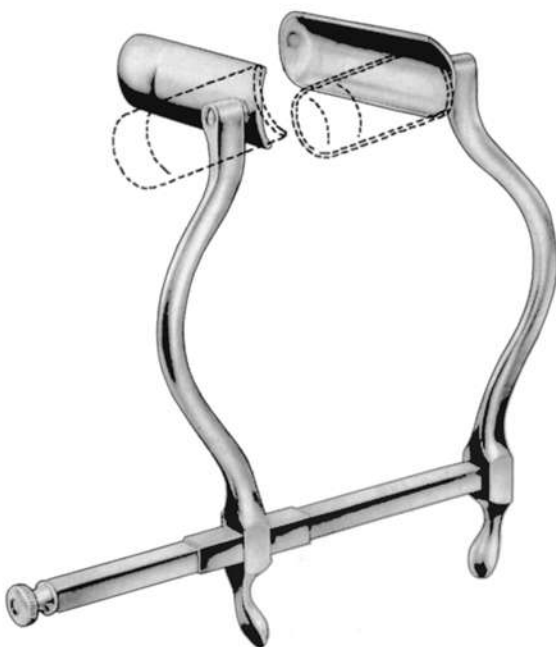

Smith-Buie
05-2211-15
15 cm / 6"

22 x 72 mm



Park
05-2212-16
16 cm / 6¹/₄"



Brinkerhoff
05-2213-13 Ø13/25 x 90 mm
05-2214-15 Ø15/25 x 100 mm
05-2215-19 Ø19/32 x 115 mm



Hirschmann
 05-2216-16 Ø 16 x 65 mm
 05-2217-19 Ø 19 x 65 mm
 05-2218-22 Ø 22 x 65 mm
 05-2219-22 Ø 22 x 125 mm



Ives-Fanster
 05-2220-22
 Ø 22 cm



Kelly
 05-2221-100 Ø 22 x 100 mm
 05-2222-140 Ø 22 x 140 mm



Kelly
 05-2223-21 Ø 21 x 50 mm
 05-2224-27 Ø 27 x 50 mm

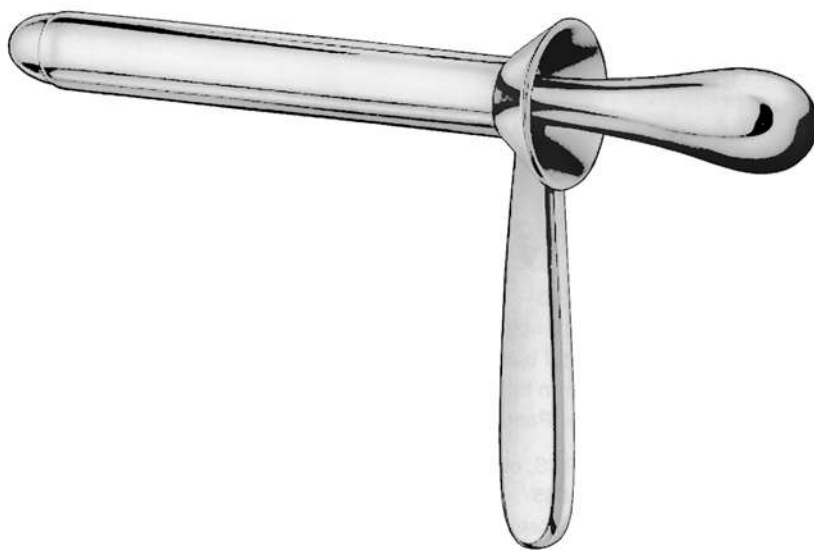

Kelly
 05-2225-142 Ø 27 x 142 mm
 05-2226-205 Ø 27 x 205 mm

Ø 2.0 mm

Ø 1.0 mm Ø 2.0 mm

11.5 cm / 4½" 05-2227-115 05-005-115
 13 cm / 5⅛" 05-2228-13 05-005-13
 14.5 cm / 5¾" 05-2229-145 05-005-145
 16 cm / 6¼" 05-2230-16 05-005-16
 18 cm / 7" 05-2231-18 05-005-18
 20 cm / 8" 05-2232-20 05-005-20
 25 cm / 10" 05-2233-25 05-005-25

11.5 cm / 4½" 05-2234-115
 13 cm / 5⅛" 05-2235-13
 14.5 cm / 5¾" 05-2236-145
 16 cm / 6¼" 05-2237-16
 18 cm / 7" 05-2238-18
 20 cm / 8" 05-2239-20
 25 cm / 10" 05-2240-25

14.5 cm / 5¾" 05-2241-145
 16 cm / 6¼" 05-2242-16

Ø 3.5 mm

11.5 cm / 4½" 05-2243-115
 13 cm / 5⅛" 05-2244-13
 14.5 cm / 5¾" 05-2245-145
 16 cm / 6¼" 05-2246-16
 18 cm / 7" 05-2247-18
 20 cm / 8" 05-2248-20

Netalon
 05-2249-16
 16 cm / 6¼"

Ø 3.3 mm

13 cm / 5⅛" 05-2250-13
 14.5 cm / 5¾" 05-2251-145
 16 cm / 6¼" 05-2252-16



Lockhart-Mummery
 05-2253-165
 16.5 cm / 6½"

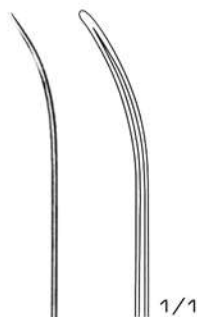

Lockhart-Mummery
 05-2254-165
 16.5 cm / 6½"

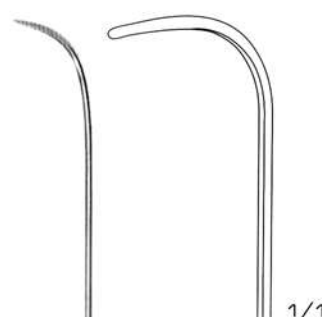

Lockhart-Mummery
 05-2255-165
 16.5 cm / 6½"

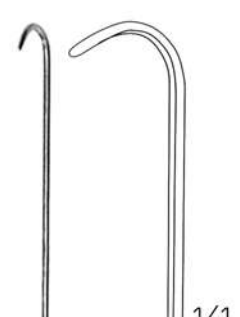

Lockhart-Mummery
 05-2256-165
 16.5 cm / 6½"





12 cm / 4³/₄" 05-2257-12 Ø 0.9 mm
 14 cm / 5¹/₂" 05-2258-14 Ø 0.9 mm
 16 cm / 6¹/₄" 05-2259-16 Ø 1.1 mm
 18 cm / 7" 05-2260-18 Ø 1.2 mm

Farrell (Lathbury)



12 cm / 4³/₄" 05-2261-12 Ø 0.9 mm
 14 cm / 5¹/₂" 05-2262-14 Ø 0.9 mm
 16 cm / 6¹/₄" 05-2263-16 Ø 1.1 mm
 18 cm / 7" 05-2264-18 Ø 1.2 mm

Farrell

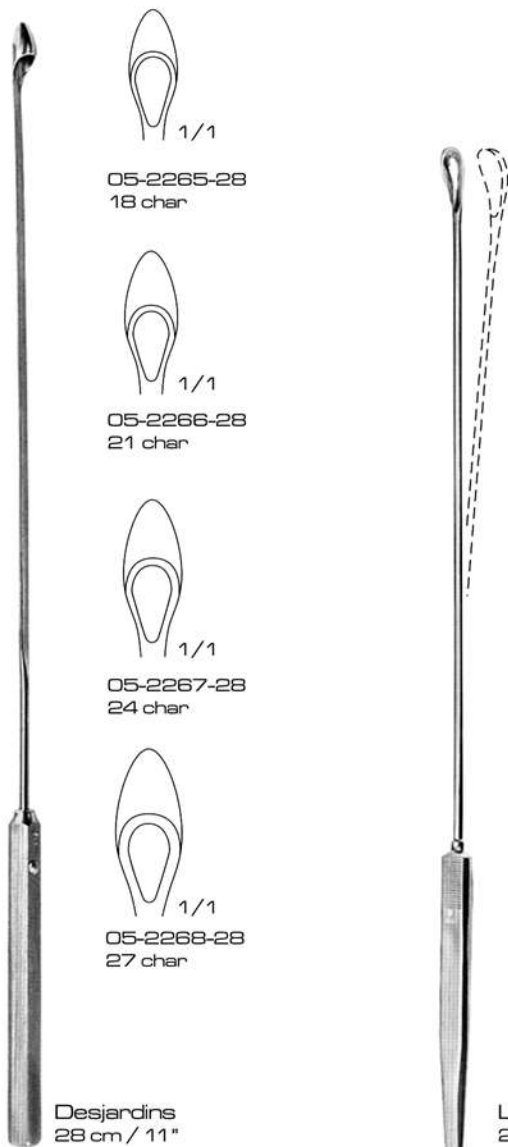

Desjardins
28 cm / 11"

Luer-Korte
24 cm / 9¹/₂"



05-2265-28
18 char



05-2266-28
21 char

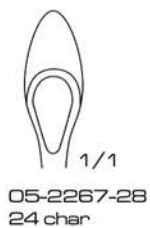

05-2267-28
24 char



05-2268-28
27 char

Fig. 000



05-2269-24
2.8 mm

Fig. 00



05-2270-24
3.4 mm

Fig. 0



05-2271-24
4.3 mm

Fig. 1



05-2272-24
5.5 mm

Fig. 2



05-2273-24
6.7 mm

Fig. 3



05-2274-24
8 mm

Fig. 4



05-2275-24
11 mm

Fig. 5



05-2276-24
15 mm



Randall



1/1
05-2277-23
23 cm / 9"

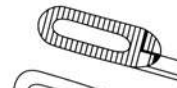

1/1
05-2278-22
22 cm / 8 3/4"

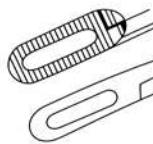
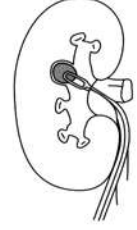

1/1
05-2279-22
22 cm / 8 3/4"

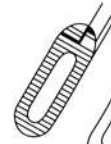
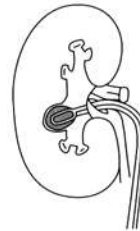

1/1
05-2280-22
22 cm / 8 3/4"

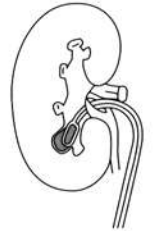

Strauss
05-2281-11
11 cm / 4 1/4"



Stockmann
05-2282-08
8 cm / 3 1/4"

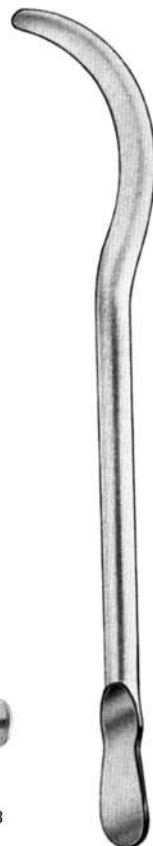

Guyon
27 cm / 10 1/2"

- Char: 10 05-2283-27
- Char: 11 05-2284-27
- Char: 12 05-2285-27
- Char: 13 05-2286-27
- Char: 14 05-2287-27
- Char: 15 05-2288-27
- Char: 16 05-2289-27
- Char: 17 05-2290-27
- Char: 18 05-2291-27
- Char: 19 05-2292-27
- Char: 20 05-2293-27
- Char: 21 05-2294-27
- Char: 22 05-2295-27
- Char: 23 05-2296-27
- Char: 24 05-2297-27
- Char: 25 05-2298-27
- Char: 26 05-2299-27
- Char: 27 05-2300-27
- Char: 28 05-2301-27
- Char: 29 05-2302-27
- Char: 30 05-2303-27

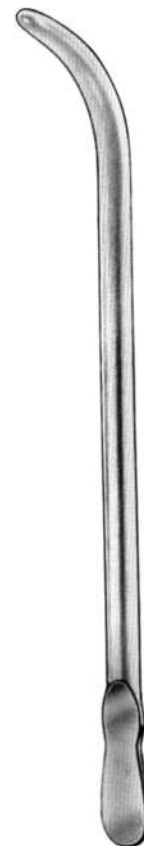

Van Buren
28 cm / 11"

- Char: 8 05-2304-28
- Char: 10 05-2305-28
- Char: 12 05-2306-28
- Char: 14 05-2307-28
- Char: 16 05-2308-28
- Char: 18 05-2309-28
- Char: 20 05-2310-28
- Char: 22 05-2311-28
- Char: 24 05-2312-28
- Char: 26 05-2313-28
- Char: 28 05-2314-28
- Char: 30 05-2315-28
- Char: 32 05-2316-28
- Char: 34 05-2317-28
- Char: 36 05-2318-28

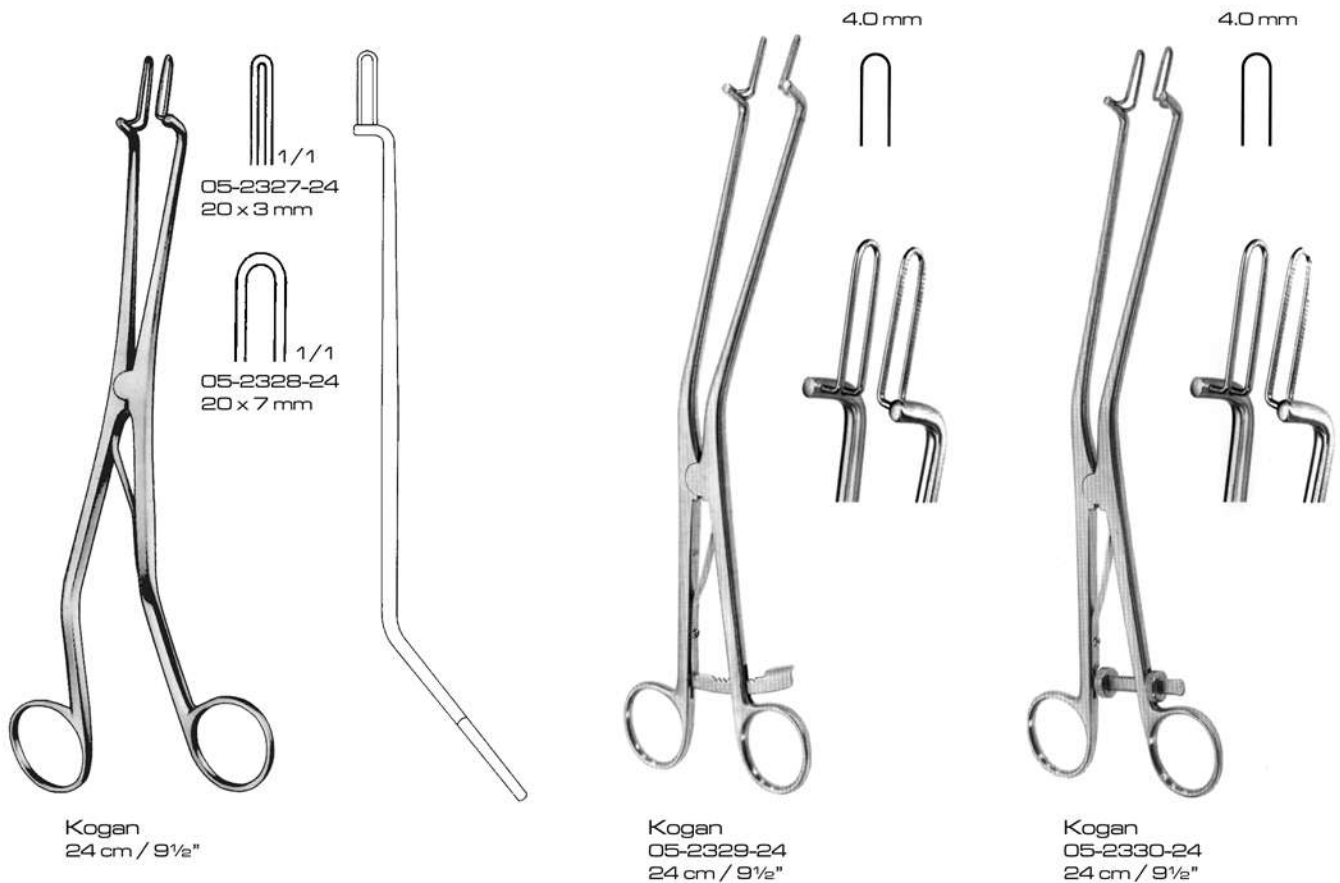



central fixation screw

Cusco
 75 x 32 mm 05-2331-75
 85 x 36 mm 05-2332-85
 95 x 37 mm 05-2333-95
 Also available in black color



lateral fixation screw

Cusco
 75 x 17 mm
 05-2334-75
 Also available in black color



lateral fixation screw

Cusco
 75 x 32 mm 05-2335-75
 85 x 35 mm 05-2336-85
 100 x 35 mm 05-2337-100
 Also available in black color



swiss pattern

Cusco
 90 x 23-25 mm 05-2338-90
 100 x 25-27 mm 05-2339-100
 110 x 27-30 mm 05-2340-110
 Also available in black color



Cusco (Japanese Model)
 small 05-2341-00
 medium 05-2342-00
 large 05-2343-00
 Also available in black color



Collin
 65 x 20 mm 05-2344-65
 85 x 30 mm 05-2345-85
 90 x 16 mm 05-2346-90
 100 x 35 mm 05-2347-100
 110 x 40 mm 05-2348-110
 Also available in black color



Collin (New Model)
 Virgin 65 x 20 mm 05-2349-65
 Small 85 x 30 mm 05-2350-85
 Medium 100 x 35 mm 05-2351-100
 Large 110 x 40 mm 05-2352-110
 Chromium plated in black color



with detachable weight

Auvard
 05-2353-75
 75 x 38 mm



with fixed weight

Auvard
 05-2354-105
 105 x 38 mm



Specula only, deep hollow

Kristeller

70 x 27 mm 05-2355-70
 80 x 30 mm 05-2356-80
 90 x 36 mm 05-2357-90

 110 x 27 mm 05-2358-27
 110 x 30 mm 05-2359-30
 110 x 36 mm 05-2360-36

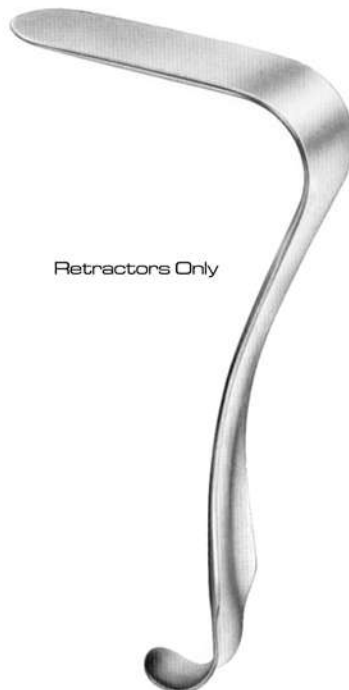

Retractors Only

Kristeller

75 x 23 mm 05-2361-75
 85 x 26 mm 05-2362-85
 100 x 32 mm 05-2363-100

 115 x 23 mm 05-2364-23
 115 x 26 mm 05-2365-26
 115 x 32 mm 05-2366-32



Set

Kristeller

Set 1 consisting 05-2355-70 & 05-2361-75
 Set 2 consisting 05-2356-80 & 05-2362-85
 Set 3 consisting 05-2357-90 & 05-2363-100

 Set 4 consisting 05-2358-27 & 05-2364-23
 Set 5 consisting 05-2359-30 & 05-2365-26
 Set 6 consisting 05-2360-36 & 05-2366-32

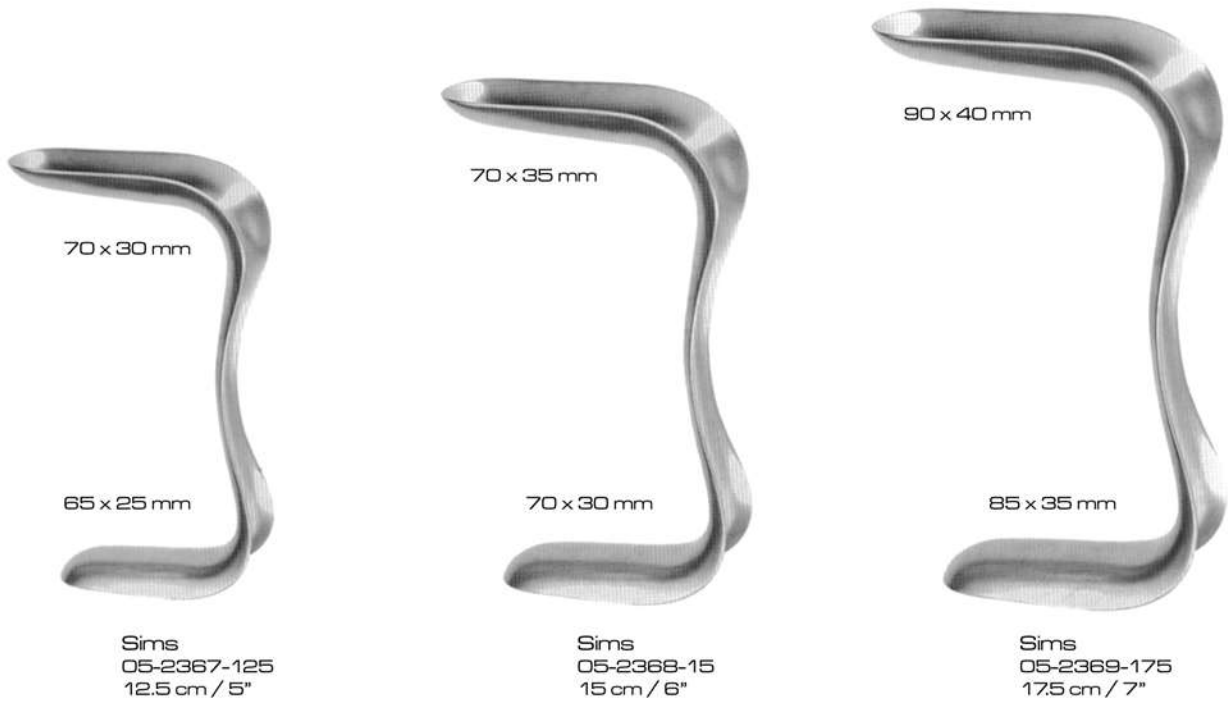

Fig. a x b

- 1 55 x 35 05-2370-23
- 2 85 x 35 05-2371-23
- 3 115 x 35 05-2372-23

- 1 55 x 45 05-2373-23
- 2 85 x 45 05-2374-23
- 3 115 x 45 05-2375-23

- 1 55 x 60 05-2376-23
- 2 85 x 60 05-2377-23
- 3 115 x 60 05-2378-23

- 100 x 20 mm 05-2379-30 30 cm / 12"
- 100 x 25 mm 05-2380-30 30 cm / 12"
- 100 x 30 mm 05-2381-30 30 cm / 12"
- 100 x 35 mm 05-2382-30 30 cm / 12"
- 100 x 40 mm 05-2383-30 30 cm / 12"

- 130 x 20 mm 05-2384-32 32 cm / 12³/₄"
- 130 x 25 mm 05-2385-32 32 cm / 12³/₄"
- 130 x 30 mm 05-2386-32 32 cm / 12³/₄"
- 130 x 35 mm 05-2387-32 32 cm / 12³/₄"
- 130 x 40 mm 05-2388-32 32 cm / 12³/₄"

- 155 x 40 mm 05-2389-35 35 cm / 14"

Doyen
23 cm / 9"

Breisky

VAGINAL SPECULA



05-2390-01
80 x 30 mm



05-2393-04
55 x 40 x 60 mm



05-2391-02
85 x 35 mm

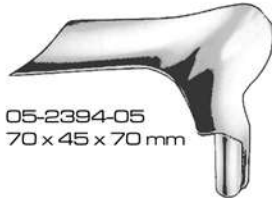

05-2394-05
70 x 45 x 70 mm



05-2392-03
85 x 40 mm



Scherbeck
05-2395-19
19 cm / 7½"



Scherbeck
05-2397-19
19 cm / 7½"



Scherbeck
05-2399-18
18 cm / 7"



Scherbeck
05-2401-00
800 gm



Scherbeck
05-2402-00 400 gm
05-2403-00 800 gm

05-2396-00
complete set with
5 blades

05-2398-00
complete set with
5 blades

05-2400-00
complete set with
5 blades



05-2404-01
80 x 30 mm



05-2408-05
65 x 30 mm



05-2405-02
85 x 33 mm



05-2409-06
75 x 35 mm



05-2406-03
100 x 38 mm



05-2410-07
85 x 35 mm



05-2407-04
110 x 42 mm



05-2411-08
95 x 35 mm



Bozemann
05-2412-23
23 cm / 9"

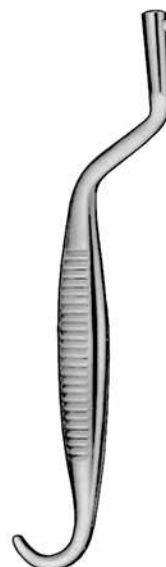

Bozemann
05-2414-22
22 cm / 8¾"



Bozemann
05-2416-23
23 cm / 9"



Bozemann
05-2418-22
22 cm / 8¾"

05-2413-00
complete set with
8 blades

05-2415-00
complete set with
8 blades

05-2417-00
complete set with
8 blades

05-2419-00
complete set with
8 blades



- Ø 1 mm 05-2420-01
- Ø 2 mm 05-2421-02
- Ø 3 mm 05-2422-03
- Ø 4 mm 05-2423-04
- Ø 5 mm 05-2424-05
- Ø 6 mm 05-2425-06
- Ø 7 mm 05-2426-07
- Ø 8 mm 05-2427-08
- Ø 9 mm 05-2428-09
- Ø 10 mm 05-2429-10
- Ø 11 mm 05-2430-11
- Ø 12 mm 05-2431-12
- Ø 13 mm 05-2432-13
- Ø 14 mm 05-2433-14
- Ø 15 mm 05-2434-15
- Ø 16 mm 05-2435-16
- Ø 17 mm 05-2436-17
- Ø 18 mm 05-2437-18
- Ø 19 mm 05-2438-19
- Ø 20 mm 05-2439-20
- Ø 21 mm 05-2440-21
- Ø 22 mm 05-2441-22
- Ø 23 mm 05-2442-23
- Ø 24 mm 05-2443-24
- Ø 25 mm 05-2444-25
- Ø 26 mm 05-2445-26
- Ø 27 mm 05-2446-27
- Ø 28 mm 05-2447-28
- Ø 29 mm 05-2448-29
- Ø 30 mm 05-2449-30

Hegar
18.5 cm / 7¼"
05-2450-185
complete set consisting:
05-2420-01 To 05-2449-30



- Ø 1.5 mm 05-2451-15
- Ø 2.5 mm 05-2452-25
- Ø 3.5 mm 05-2453-35
- Ø 4.5 mm 05-2454-45
- Ø 5.5 mm 05-2455-55
- Ø 6.5 mm 05-2456-65
- Ø 7.5 mm 05-2457-75
- Ø 8.5 mm 05-2458-85
- Ø 9.5 mm 05-2459-95
- Ø 10.5 mm 05-2460-105
- Ø 11.5 mm 05-2461-115
- Ø 12.5 mm 05-2462-125
- Ø 13.5 mm 05-2463-135
- Ø 14.5 mm 05-2464-145
- Ø 15.5 mm 05-2465-155
- Ø 16.5 mm 05-2466-165
- Ø 17.5 mm 05-2467-175
- Ø 18.5 mm 05-2468-185
- Ø 19.5 mm 05-2469-195

Hegar
18.5 cm / 7¼"
05-2470-185
complete set consisting:
05-2451-15 To 05-2469-195



205 x 105 x 45 mm

Hegar
05-2471-00
Set
Ø 1.0 - Ø 26.0
(26 dilators)

05-2472-00
Set
Ø 4.0 - Ø 17.0
(14 dilators)

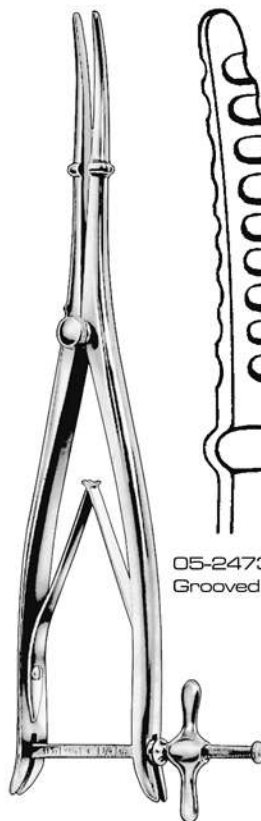

Wylie
29 cm / 11½"

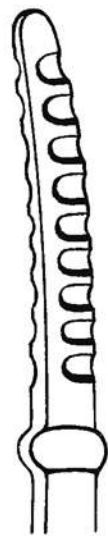

05-2473-29
Grooved



05-2474-29
Smooth

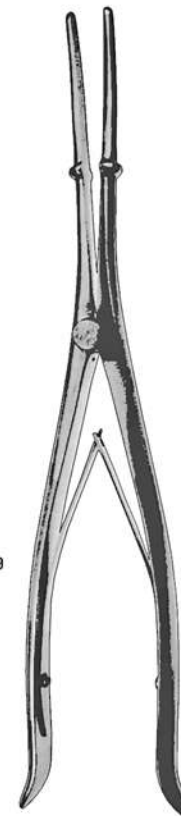

Wylie
29 cm / 11½"

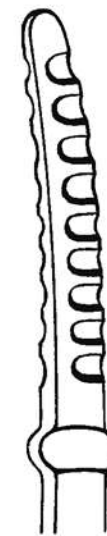

05-2475-29
Grooved



05-2476-29
Smooth



- | | |
|------------------|------------|
| Ø 1.0 / 2.0 mm | 05-2477-01 |
| Ø 3.0 / 4.0 mm | 05-2478-03 |
| Ø 5.0 / 6.0 mm | 05-2479-05 |
| Ø 7.0 / 8.0 mm | 05-2480-07 |
| Ø 9.0 / 10.0 mm | 05-2481-09 |
| Ø 11.0 / 12.0 mm | 05-2482-11 |
| Ø 13.0 / 14.0 mm | 05-2483-13 |
| Ø 15.0 / 16.0 mm | 05-2484-15 |
| Ø 17.0 / 18.0 mm | 05-2485-17 |
| Ø 19.0 / 20.0 mm | 05-2486-19 |
| Ø 21.0 / 22.0 mm | 05-2487-21 |
| Ø 23.0 / 24.0 mm | 05-2488-23 |
| Ø 25.0 / 26.0 mm | 05-2489-25 |

05-2490-00
complete set consisting:
05-2477-01 To 05-2489-25



Hegar
05-2491-00 (Set with pouch)
Ø 3.0 / 4.0 - Ø 17.0 / 18.0 mm
(8 dilators)

05-2492-00 (Set with pouch)
Ø 1.0 / 2.0 - Ø 25.0 / 26.0 mm
(13 dilators)



- | | |
|------------------|-------------|
| Ø 4.5 / 5.0 mm | 05-2493-45 |
| Ø 5.5 / 6.0 mm | 05-2494-55 |
| Ø 7.5 / 8.0 mm | 05-2495-75 |
| Ø 8.5 / 9.0 mm | 05-2496-85 |
| Ø 9.5 / 10.0 mm | 05-2497-95 |
| Ø 11.5 / 12.0 mm | 05-2498-115 |
| Ø 12.5 / 13.0 mm | 05-2499-125 |
| Ø 13.5 / 14.0 mm | 05-2500-135 |

05-2501-00
complete set consisting:
05-2493-45 To 05-2500-135

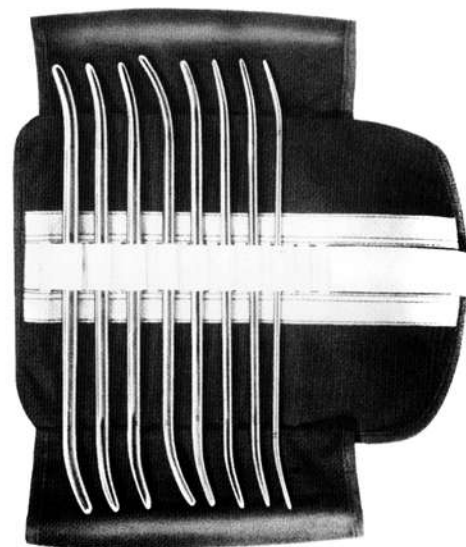

Pratt
05-2502-00 (Set with pouch)
Ø 4.5 / 5.0 - Ø 13.5 / 14.0 mm
(8 dilators)

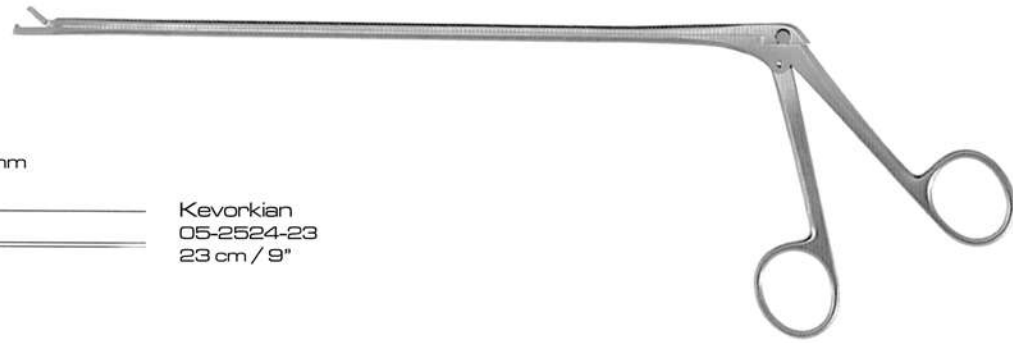

9 x 3 mm

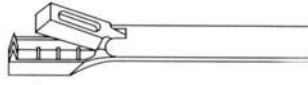

1/1

Kevorkian
05-2524-23
23 cm / 9"

9 x 3 mm

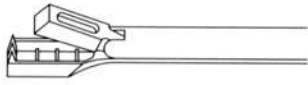

1/1

Kevorkian
05-2525-25
25 cm / 10"

4.5 x 8 mm

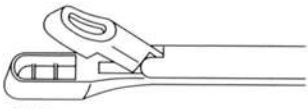

1/1

Eppendorf
05-2526-23
23 cm / 9"

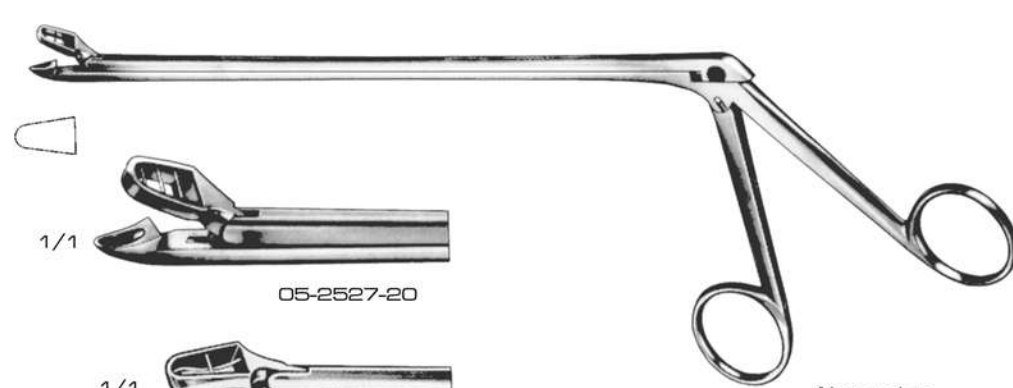

1/1



05-2527-20

1/1



05-2528-20

Alexander
Shaft Length
20 cm / 8"



1/1



1/1



05-2529-24

1/1



05-2530-24

Schumacher
Shaft Length
24 cm / 9½"

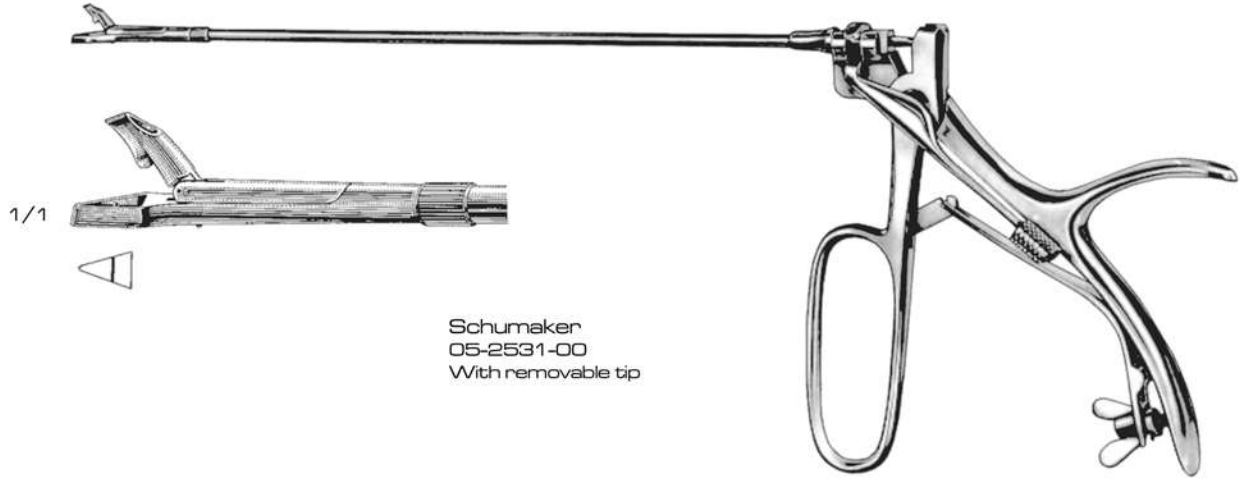

Schumaker
05-2531-00
With removable tip

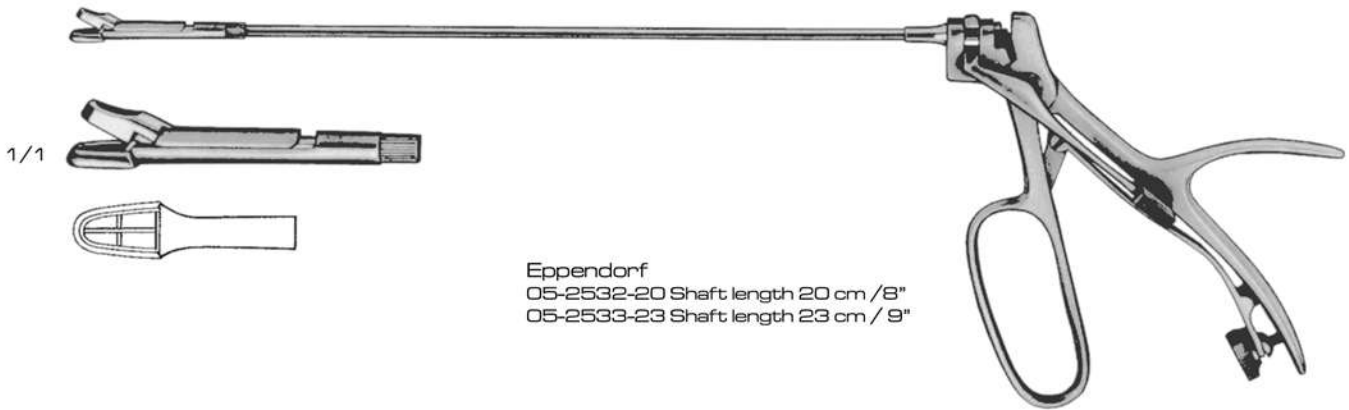

Eppendorf
05-2532-20 Shaft length 20 cm / 8"
05-2533-23 Shaft length 23 cm / 9"

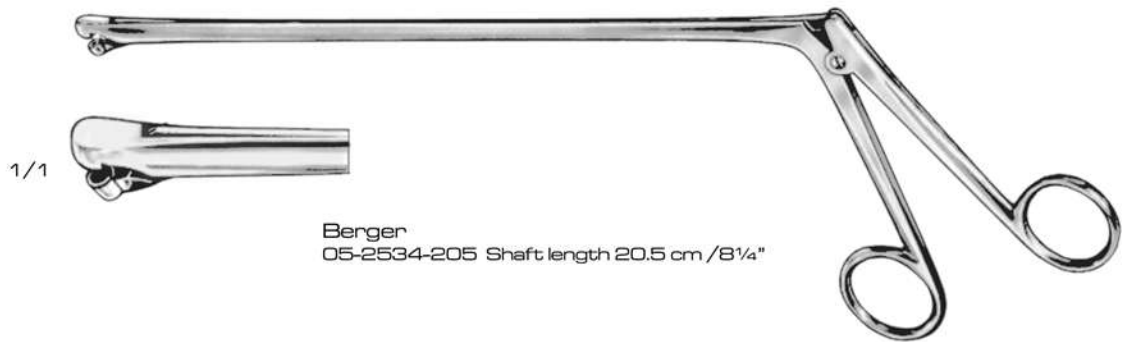

Berger
05-2534-205 Shaft length 20.5 cm / 8 1/4"

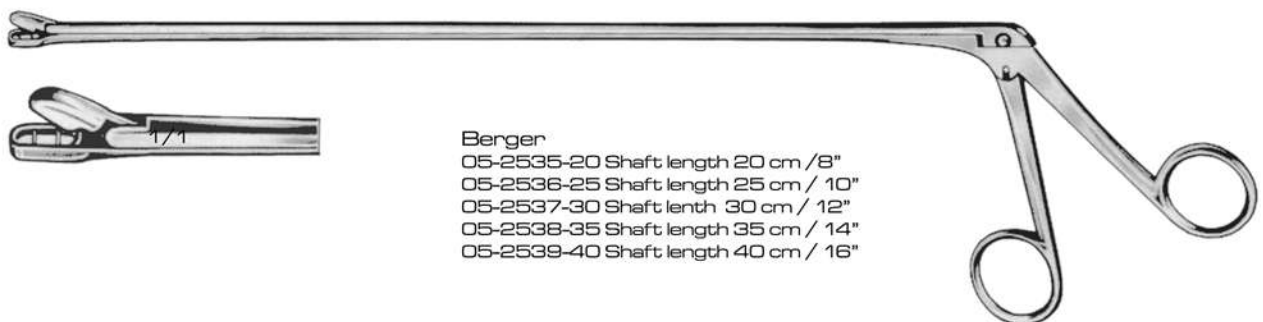

Berger
05-2535-20 Shaft length 20 cm / 8"
05-2536-25 Shaft length 25 cm / 10"
05-2537-30 Shaft length 30 cm / 12"
05-2538-35 Shaft length 35 cm / 14"
05-2539-40 Shaft length 40 cm / 16"

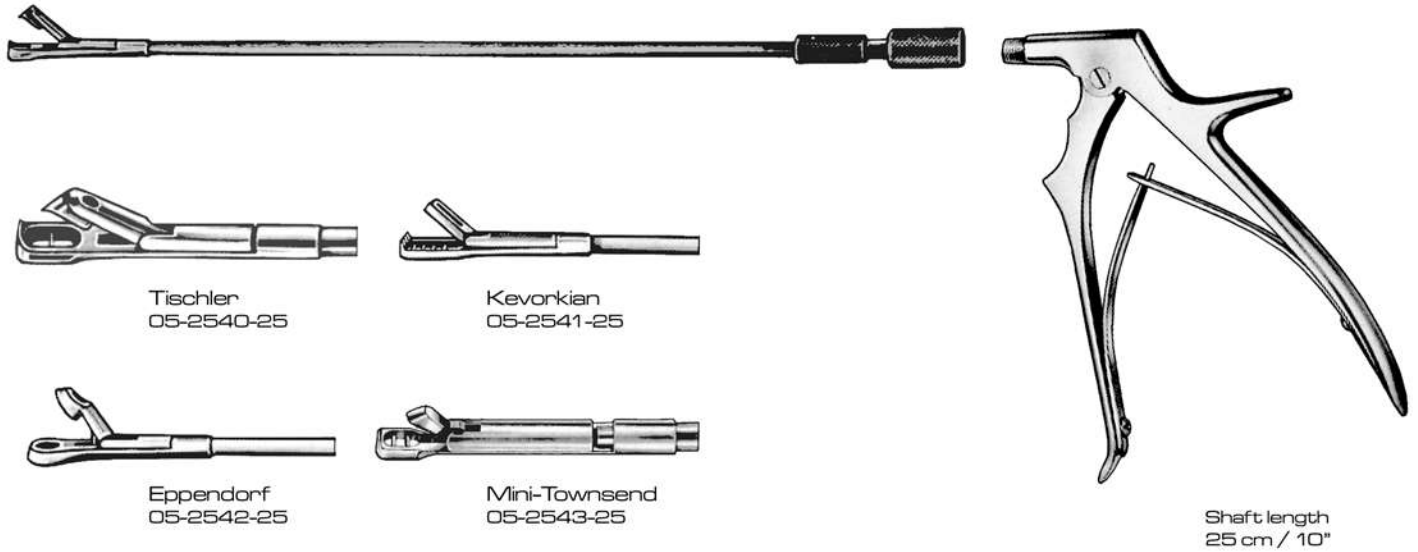

Tischler
05-2540-25

Kevorkian
05-2541-25

Eppendorf
05-2542-25

Mini-Townsend
05-2543-25

Shaft length
25 cm / 10"



9 x 3 mm



Tischler
05-2544-22
22 cm / 8 3/4"

1/1

7 x 3 mm



Tischler-Morgan
05-2545-21
21 cm / 8 1/4"

1/1

9 x 3 mm



1/1

Tischler-Kevorkian
05-2547-21
21 cm / 8 1/4"

2.3 x 4 mm



Baby-Tischler
05-2546-20
20 cm / 8"

1/1

2.3 x 4 mm



1/1

Baby-Tischler
05-2548-20
20 cm / 8"

without fixing screw



Van-Doren
05-2549-25
25 cm / 10"



Van-Doren
05-2550-25
25 cm / 10"



Schubert
05-2551-26
26 cm / 10 1/4"

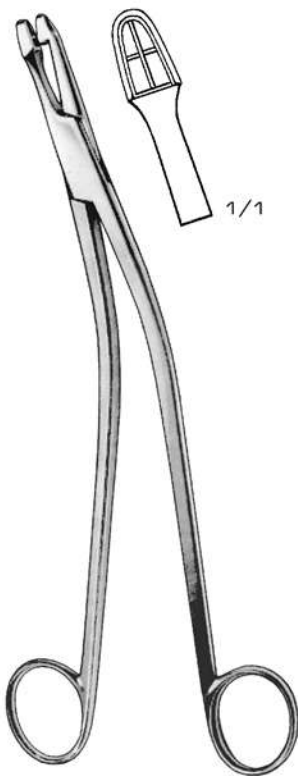

Schubert
05-2552-21
21 cm / 8 1/4"



Schubert
05-2553-21 21 cm / 8 1/4"
05-2554-29 29 cm / 11 1/2"

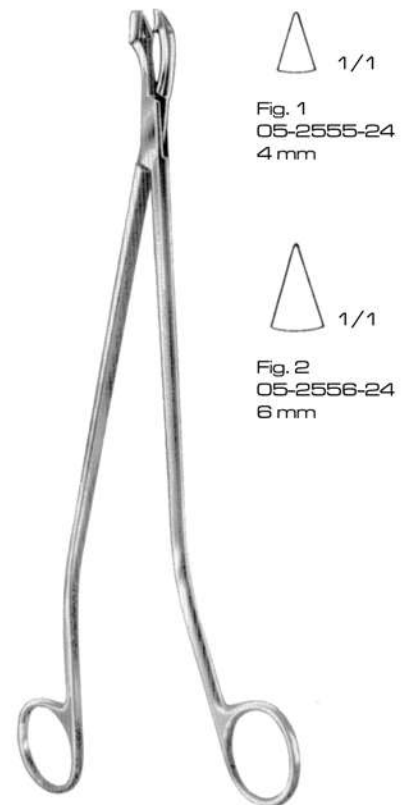

Schumacher-Van-Doren
24 cm / 9 1/2"

Fig. 1
05-2555-24
4 mm

Fig. 2
05-2556-24
6 mm

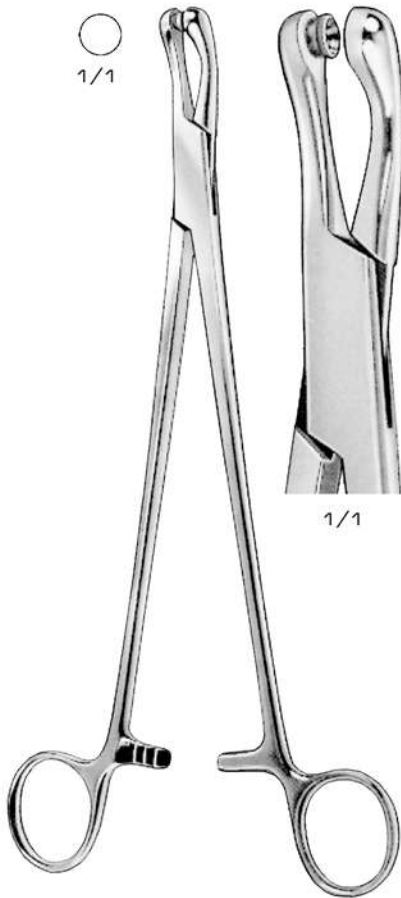

Gaylor
05-2557-24
24 cm / 9½"

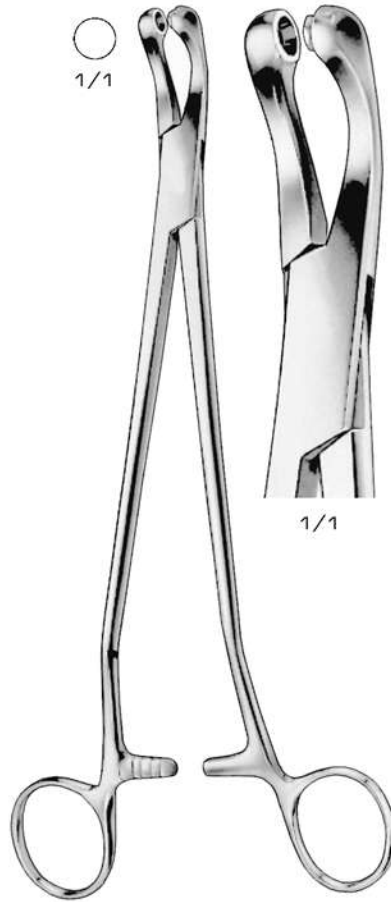

Thoms-Gaylor
05-2558-22
22 cm / 8¾"

05-2559-24
24 cm / 9½"



Faure
05-2560-21
21 cm / 8¼"

05-2561-24
24 cm / 9½"

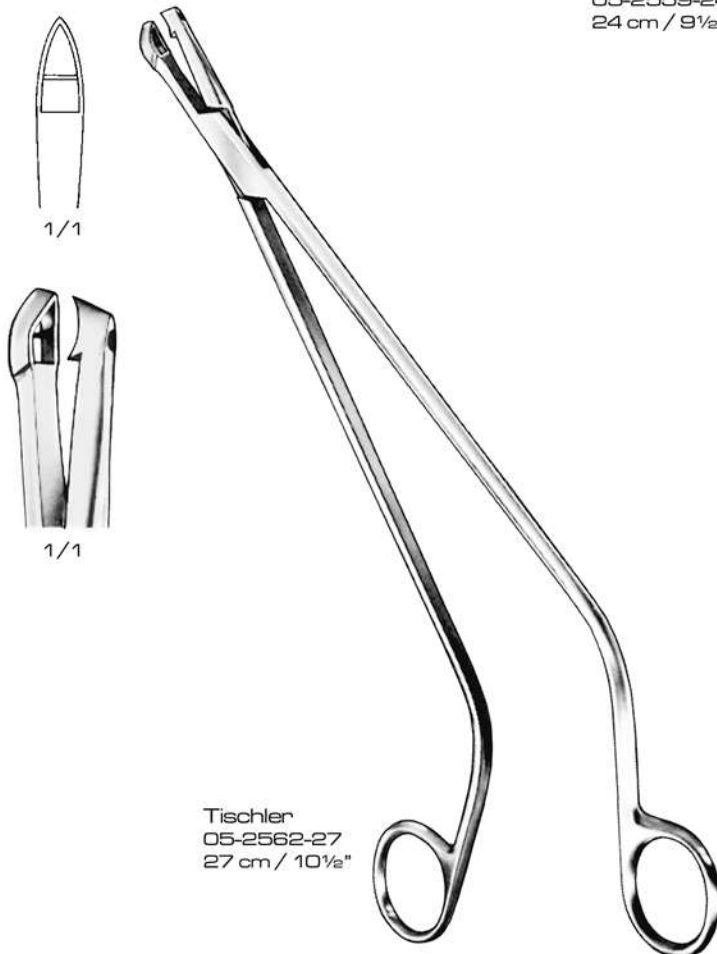

Tischler
05-2562-27
27 cm / 10½"



Medina
05-2563-24 3mm Ø
05-2564-24 4 mm Ø
05-2565-24 5 mm Ø
24 cm / 9½"

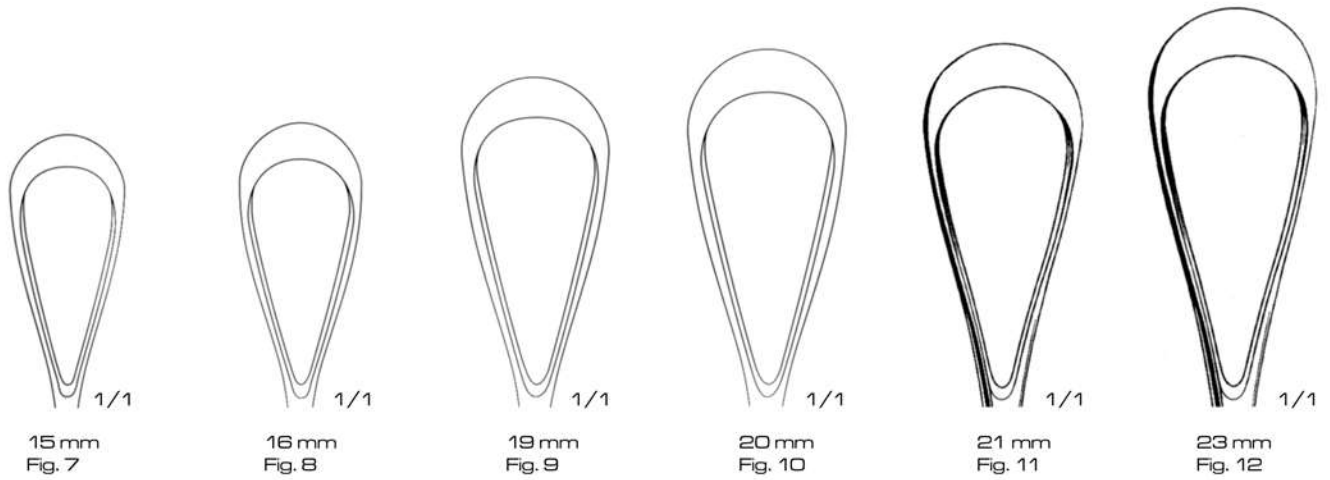
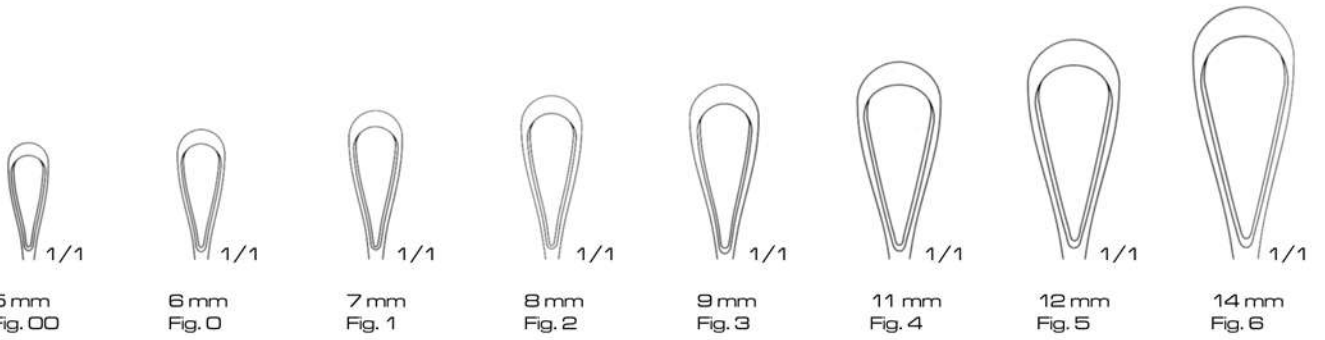

sharp, rigid

26 cm / 10 1/4" 31 cm / 12 1/4"

Fig. 00 05-2566-00	05-2580-00
Fig. 0 05-2567-0	05-2581-0
Fig. 1 05-2568-1	05-2582-1
Fig. 2 05-2569-2	05-2583-2
Fig. 3 05-2570-3	05-2584-3
Fig. 4 05-2571-4	05-2585-4
Fig. 5 05-2572-5	05-2586-5
Fig. 6 05-2573-6	05-2587-6
Fig. 7 05-2574-7	05-2588-7
Fig. 8 05-2575-8	05-2589-8
Fig. 9 05-2576-9	05-2590-9
Fig. 10 05-2577-10	05-2591-10
Fig. 11 05-2578-11	05-2592-11
Fig. 12 05-2579-12	05-2593-12

Recamier



sharp, malleable

26 cm / 10 1/4" 31 cm / 12 1/4"

Fig. 00 05-2594-00	05-2608-00
Fig. 0 05-2595-0	05-2609-0
Fig. 1 05-2596-1	05-2610-1
Fig. 2 05-2597-2	05-2611-2
Fig. 3 05-2598-3	05-2612-3
Fig. 4 05-2599-4	05-2613-4
Fig. 5 05-2600-5	05-2614-5
Fig. 6 05-2601-6	05-2615-6
Fig. 7 05-2602-7	05-2616-7
Fig. 8 05-2603-8	05-2617-8
Fig. 9 05-2604-9	05-2618-9
Fig. 10 05-2605-10	05-2619-10
Fig. 11 05-2606-11	05-2620-11
Fig. 12 05-2607-12	05-2621-12

Recamier

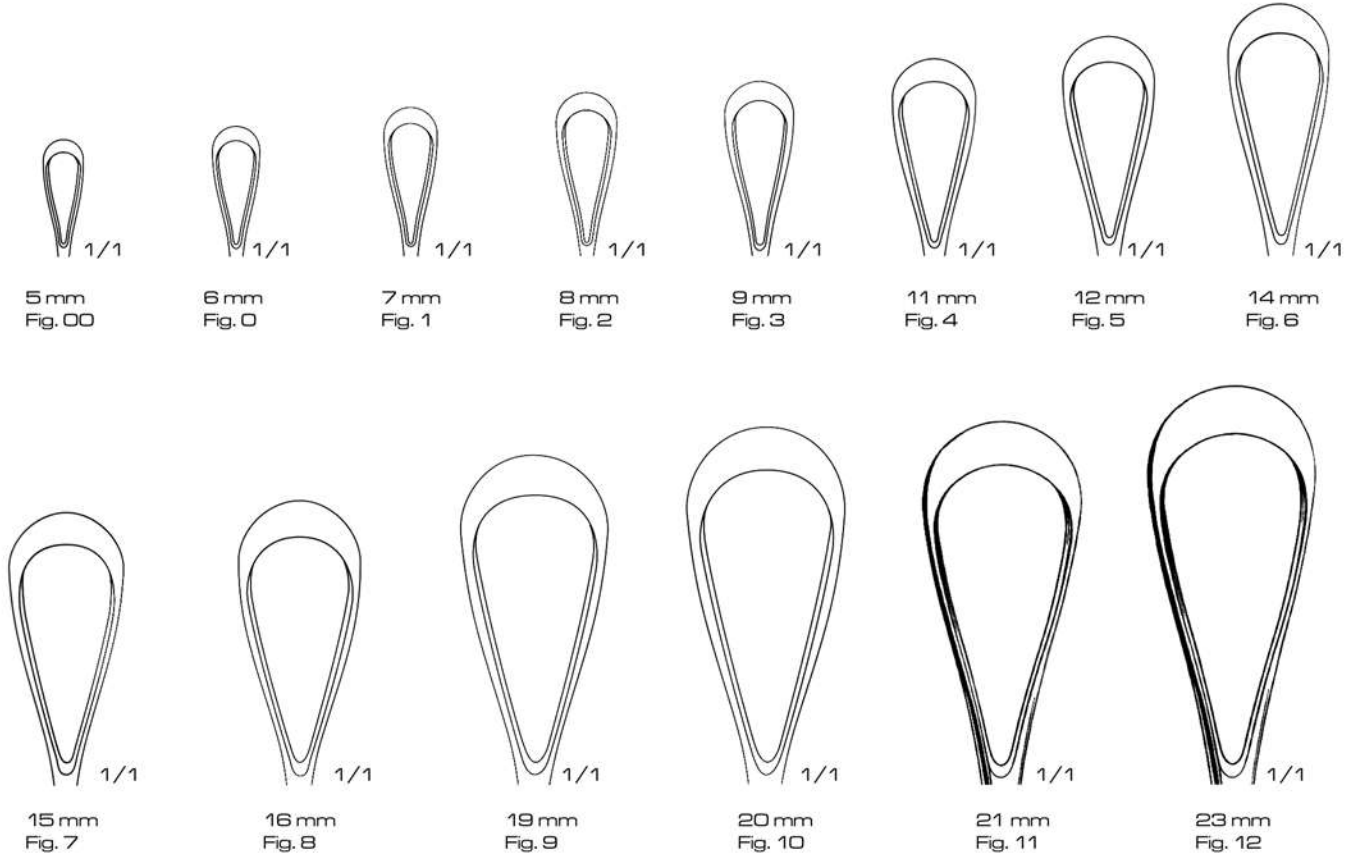

Sims

blunt, rigid

26 cm / 10 1/4" 31 cm / 12 1/4"

Fig. 00	05-2622-00	05-2636-00
Fig. 0	05-2623-0	05-2637-0
Fig. 1	05-2624-1	05-2638-1
Fig. 2	05-2625-2	05-2639-2
Fig. 3	05-2626-3	05-2640-3
Fig. 4	05-2627-4	05-2641-4
Fig. 5	05-2628-5	05-2642-5
Fig. 6	05-2629-6	05-2643-6
Fig. 7	05-2630-7	05-2644-7
Fig. 8	05-2631-8	05-2645-8
Fig. 9	05-2632-9	05-2646-9
Fig. 10	05-2633-10	05-2647-10
Fig. 11	05-2634-11	05-2648-11
Fig. 12	05-2635-12	05-2649-12



Sims

blunt, malleable

26 cm / 10 1/4" 31 cm / 12 1/4"

Fig. 00	05-2650-00	05-2664-00
Fig. 0	05-2651-0	05-2665-0
Fig. 1	05-2652-1	05-2666-1
Fig. 2	05-2653-2	05-2667-2
Fig. 3	05-2654-3	05-2668-3
Fig. 4	05-2655-4	05-2669-4
Fig. 5	05-2656-5	05-2670-5
Fig. 6	05-2657-6	05-2671-6
Fig. 7	05-2658-7	05-2672-7
Fig. 8	05-2659-8	05-2673-8
Fig. 9	05-2660-9	05-2674-9
Fig. 10	05-2661-10	05-2675-10
Fig. 11	05-2662-11	05-2676-11
Fig. 12	05-2663-12	05-2677-12



Ranathibodi
05-2678-275
27.5 cm / 11"



Ranathibodi
05-2679-25
25 cm / 10"

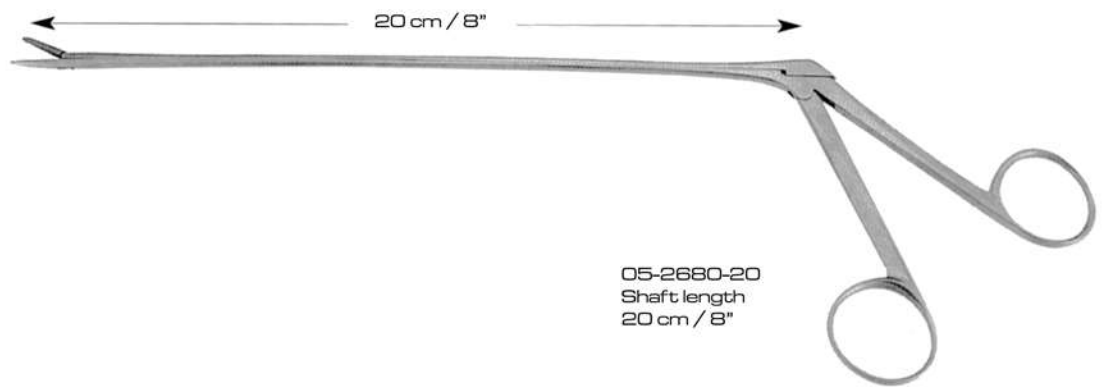

05-2680-20
Shaft length
20 cm / 8"



Char: 8 05-2681-8
Char: 10 05-2682-10
Char: 12 05-2683-12
Char: 14 05-2684-14
Char: 16 05-2685-16
Char: 18 05-2686-18



Char: 8 05-2687-8
Char: 10 05-2688-10
Char: 12 05-2689-12
Char: 14 05-2690-14
Char: 16 05-2691-16
Char: 18 05-2692-18



Char: 8 05-2693-8
Char: 10 05-2694-10
Char: 12 05-2695-12
Char: 14 05-2696-14
Char: 16 05-2697-16
Char: 18 05-2698-18



Saunders
05-2699-31
31 cm / 12 1/2"



Thomas
28 cm / 11"
Malleable, blunt

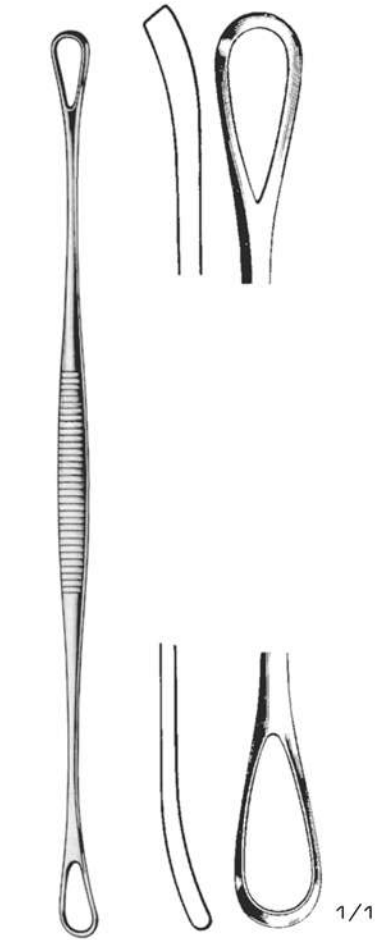

Zaufel (Blake)
05-2706-31
31 cm / 12¼"

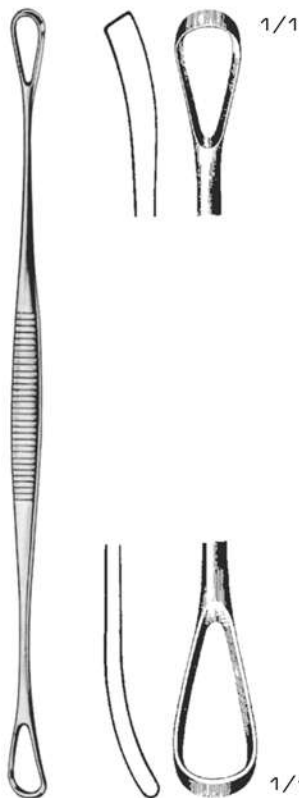

Blake
05-2707-27
27 cm / 10½"

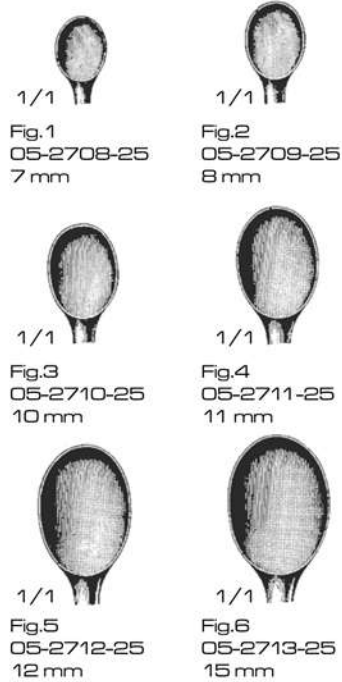

Simon
25 cm / 10"

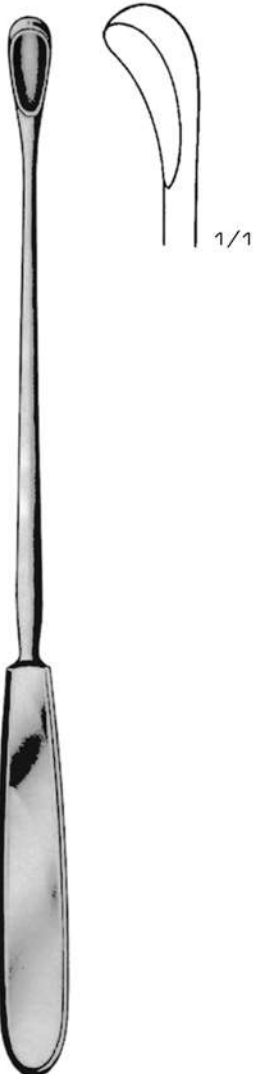
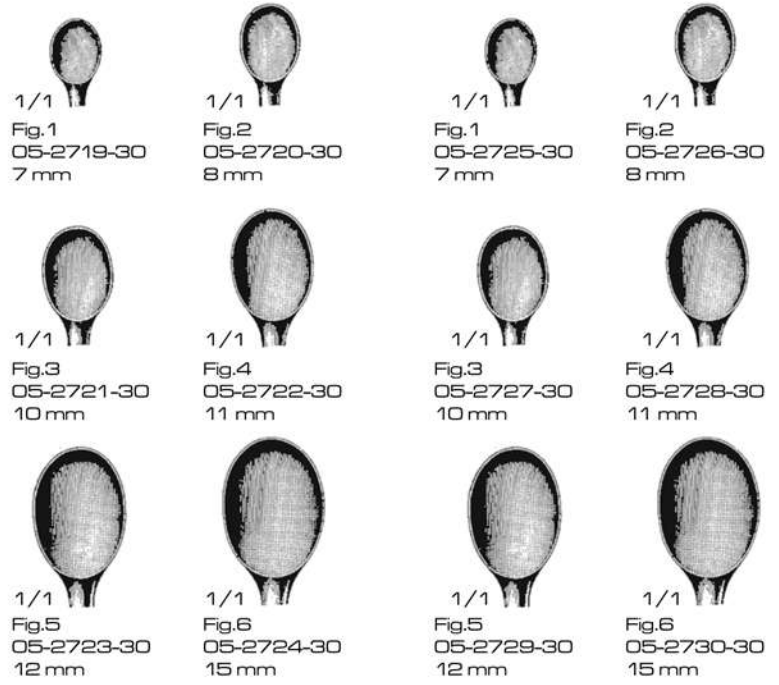
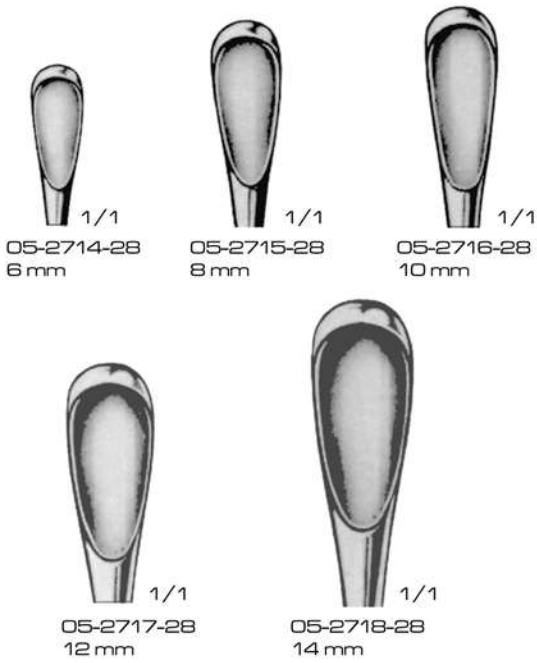

Goudet
28 cm / 11"
Blunt



Schroeder
30 cm / 12"
Sharp



Schroeder
30 cm / 12"
Sharp

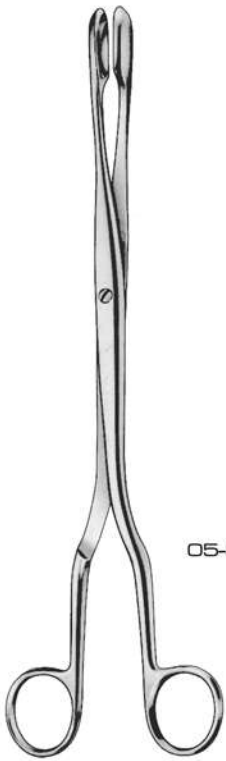

Winter
29 cm / 11 1/2"

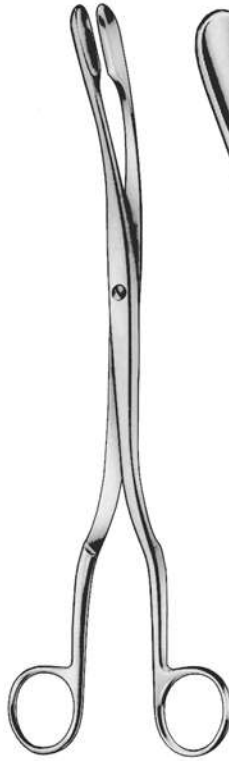
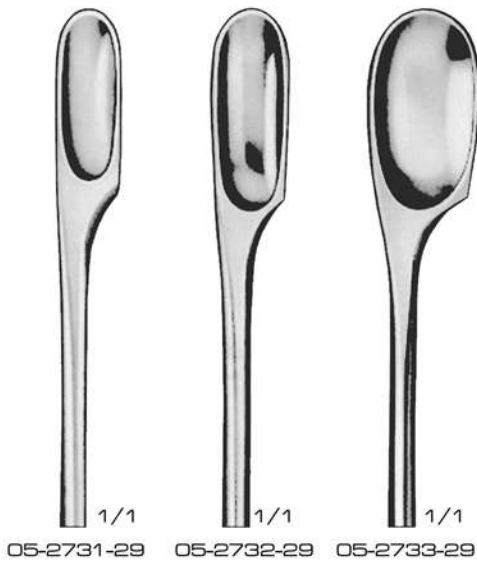

Winter
29 cm / 11 1/2"

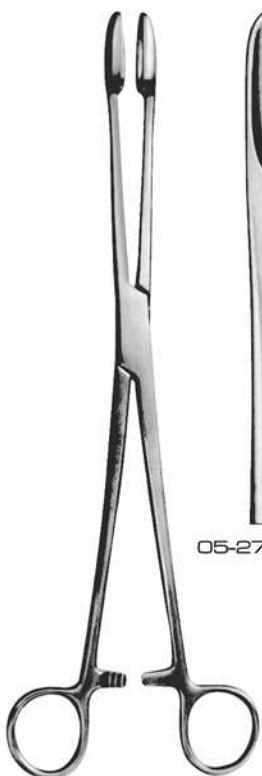
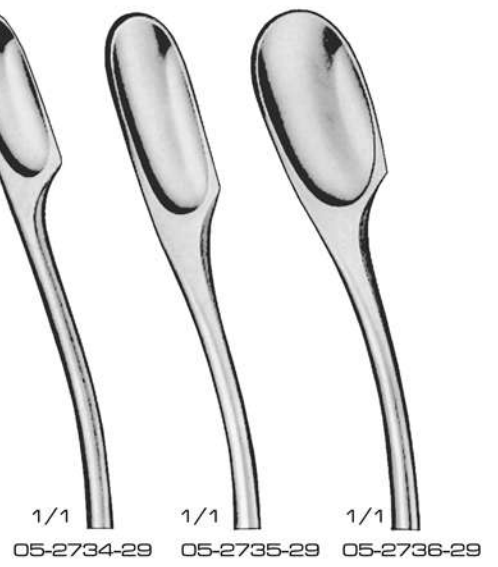

Winter
29 cm / 11 1/2"

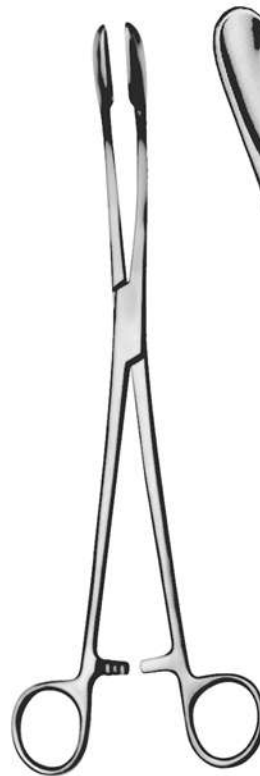

Winter
29 cm / 11 1/2"

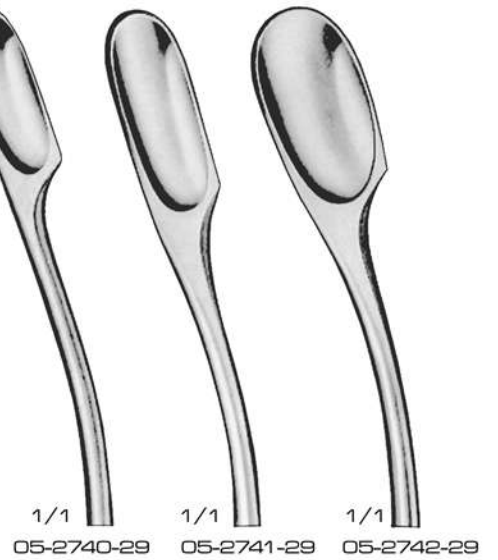



Simpson
05-2743-23
23 cm / 9"



Simpson
05-2744-30
30 cm / 12"



Simpson-Braun
05-2745-36
36 cm / 14¼"



Kielland
05-2746-41
41 cm / 16"

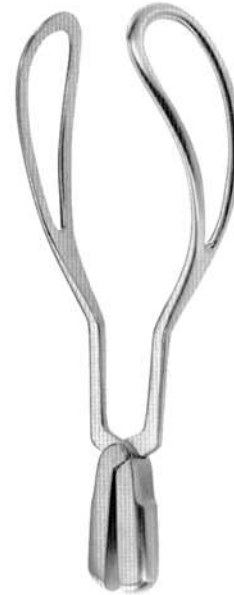

Wrigley
05-2747-28
28 cm / 11"



De Lee
05-2748-30
30 cm / 12"



Piper
05-2749-44
44 cm / 17¼"



Naegele
05-2750-36
36 cm / 14¼"

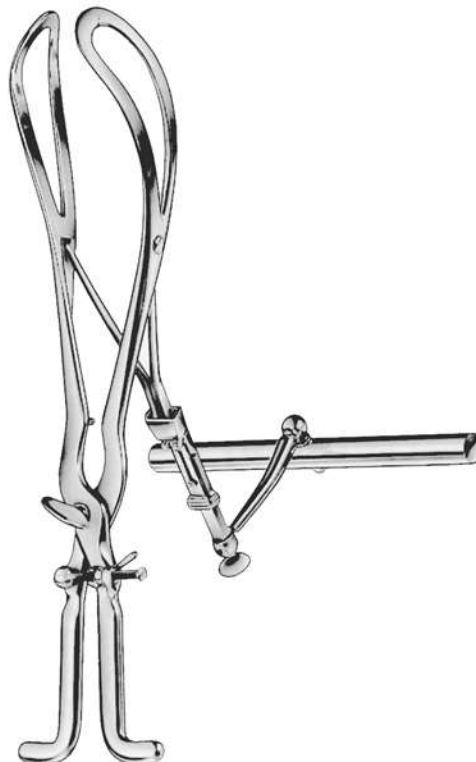

Tarnier
05-2751-40
40 cm / 16"
With traction rod



Joll (Friedman)
05-2752-15
15 cm / 6"

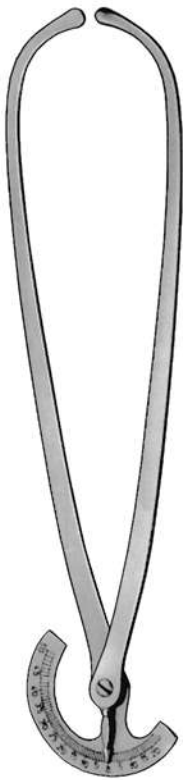

Collin
05-2753-345
34.5 cm / 13³/₄"
Graduated in centimeters

1/1



05-2754-39
39 cm / 15¹/₂"
Graduated in centimeters



05-2755-39
39 cm / 15¹/₂"
Graduated in centimeters
The additional straight arm can be replaced



Breisky
05-2756-33
33 cm / 13¹/₄"
Graduated in centimeters

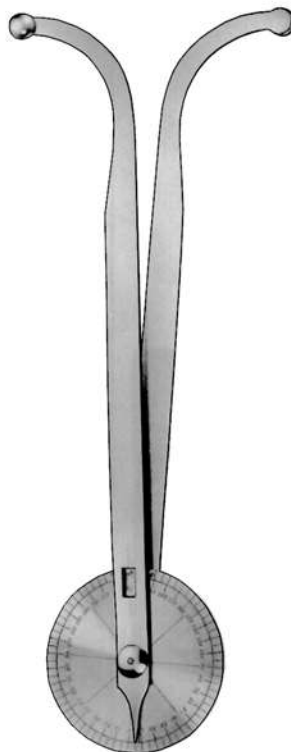

Thole
05-2757-33
33 cm / 13¹/₄"
Graduated in centimeters



De Lee
05-2758-15
15 cm / 6"
For interior measurements,
between symphysis and
promontory

Scalpels



OGE
ORTHOGENT
ENGINEERING

Also available in Non-Magnet Stainless Steel (18/8-304)



05-2759-12.5
12.5 cm / 5"
No. 3

05-2760-12.5
12.5 cm / 5"
No. 3

05-2761-21
21 cm / 8¼"
No. 3L

05-2762-20
20 cm / 8"
No. 3L

05-2763-135
13.5 cm / 5¼"
No. 4

05-2764-21
21 cm / 8¼"
No. 4L

05-2765-20
20 cm / 8"
No. 4L

Also available in Non-Magnet Stainless Steel (18/8-304)



05-2766-15
15 cm / 6"
No. 3
Hollow Handle



05-2767-15.5
15.5 cm / 6 1/4"
No. 3, 4
Double Ended



05-2768-12.5
12.5 cm / 5"
No. 7 K



05-2769-16
16 cm / 6 1/4"
No. 7



05-2770-16
16 cm / 6 1/4"
No. 7



05-2771-16
16 cm / 6 1/4"



05-2772-11
11 cm / 4¼"



Castrovejio
05-2773-13
13 cm / 5"
8 mm



05-2774-16
16 cm / 6¼"



1/1

05-2775-165



1/1

05-2776-165



1/1

05-2777-165



1/1

05-2778-165



1/1

05-2779-165



1/1

Dieffenbach
16.5 cm / 6½"



1/1

05-2780-165



1/1

05-2781-165



1/1

05-2782-165



1/1

05-2783-165



Troutman Chris
05-2784-9
9 cm / 3½"
5.5 mm

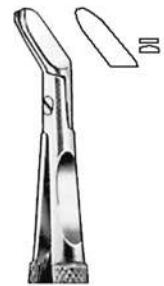

Troutman Chris
05-2785-9
9 cm / 3½"
5.5 mm

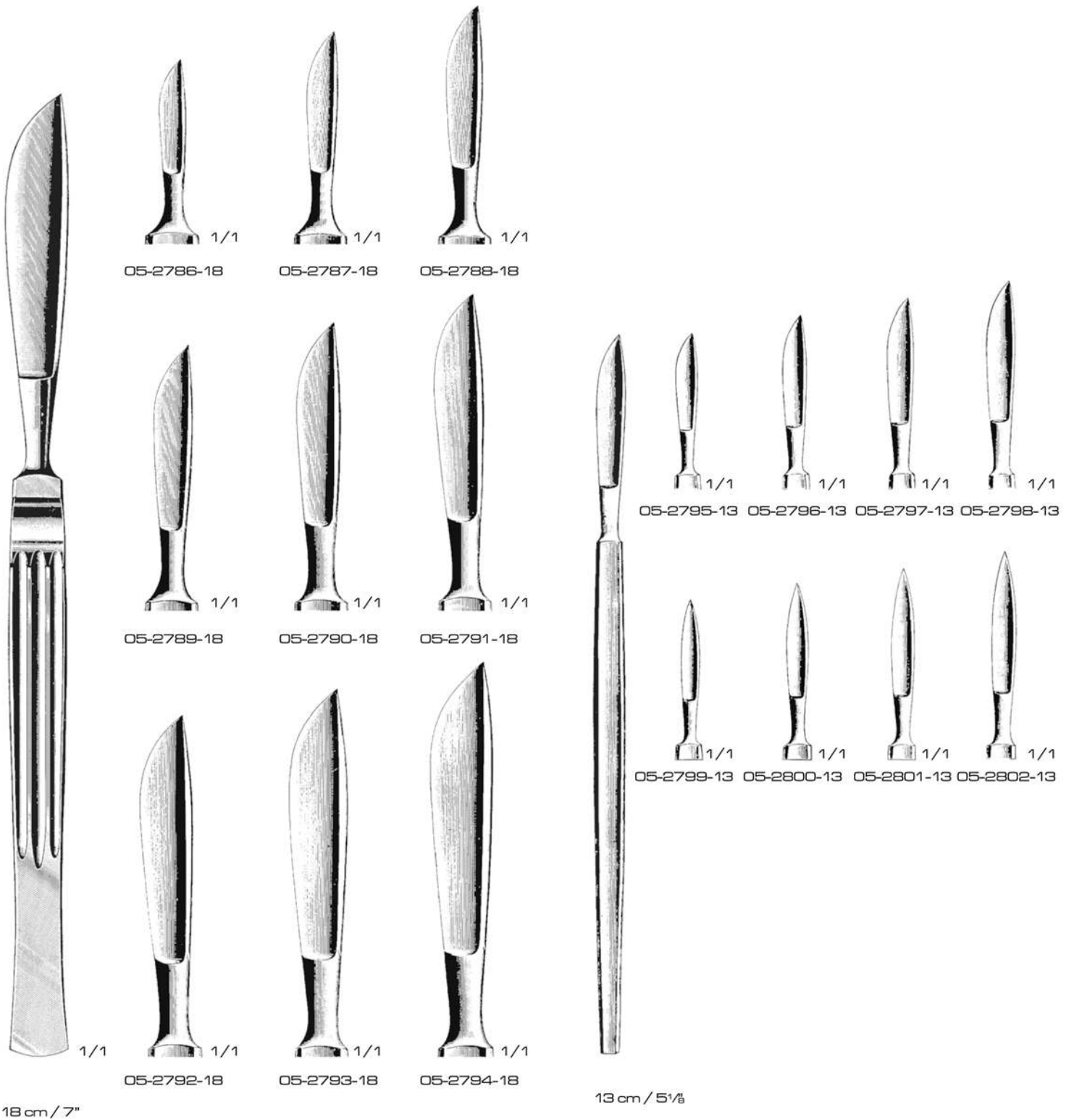



Virchow
05-2803-17
17 cm / 6¾"

Virchow
05-2804-19
19 cm / 7½"

05-2805-19
19 cm / 7½"

Virchow
05-2806-24
24 cm / 9½"

Virchow
05-2810-21
21 cm / 8¼"
Plastic handle

05-2811-21
21 cm / 8¼"
Plastic handle

Virchow
05-2812-24
24 cm / 9½"
Plastic handle

05-2813-24
24 cm / 9½"

Virchow
05-2814-215
21.5 cm / 8½"
Plastic handle

Segond
05-2807-27
27 cm / 10½"
Myomatome

05-2808-23
23 cm / 9"
Cone knife

Ayre
05-2809-235
23.5 cm / 9¼"
Cone knife



05-2815-23
23 cm / 9"
Plastic Handle

05-2816-25
25 cm / 10"

05-2817-175
17.5 cm / 7"
Plastic Handle

05-2818-175
17.5 cm / 7"

Langenbeck
17.5 cm / 7"

05-2821-175

1/1 05-2819-175 1/1 05-2820-175

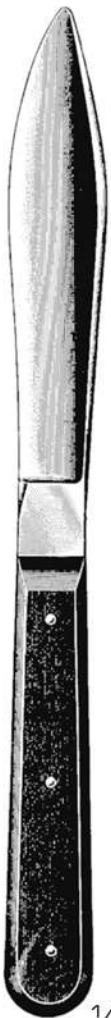

1/2

05-2822-27
27 cm / 10½"
Plastic Handle



1/2

05-2823-23
23 cm / 9"



1/2

05-2824-29
29 cm / 11½"



1/2

05-2825-34
34 cm / 13½"



1/1



1/2

05-2826-23
23 cm / 9"
Plastic handle



1/2

05-2827-29
29 cm / 11½"
Plastic handle



1/2

Walbb
 05-2828-115
 11.5 cm / 4½"
 05-2829-135
 13.5 cm / 5¼"
 05-2830-165
 16.5 cm / 6½"
 Blade sizes



1/2

Virchow
 05-2831-28
 28 cm / 11"
 Blade size
 18 cm / 7"



1/2

Virchow
 05-2832-32
 32 cm / 12"
 Blade size
 20 cm / 8"

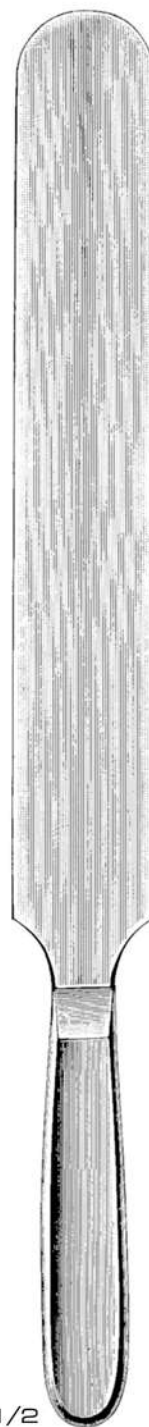

1/2

Virchow
 05-2833-36
 36 cm / 14½"
 Blade size
 24 cm / 9½"

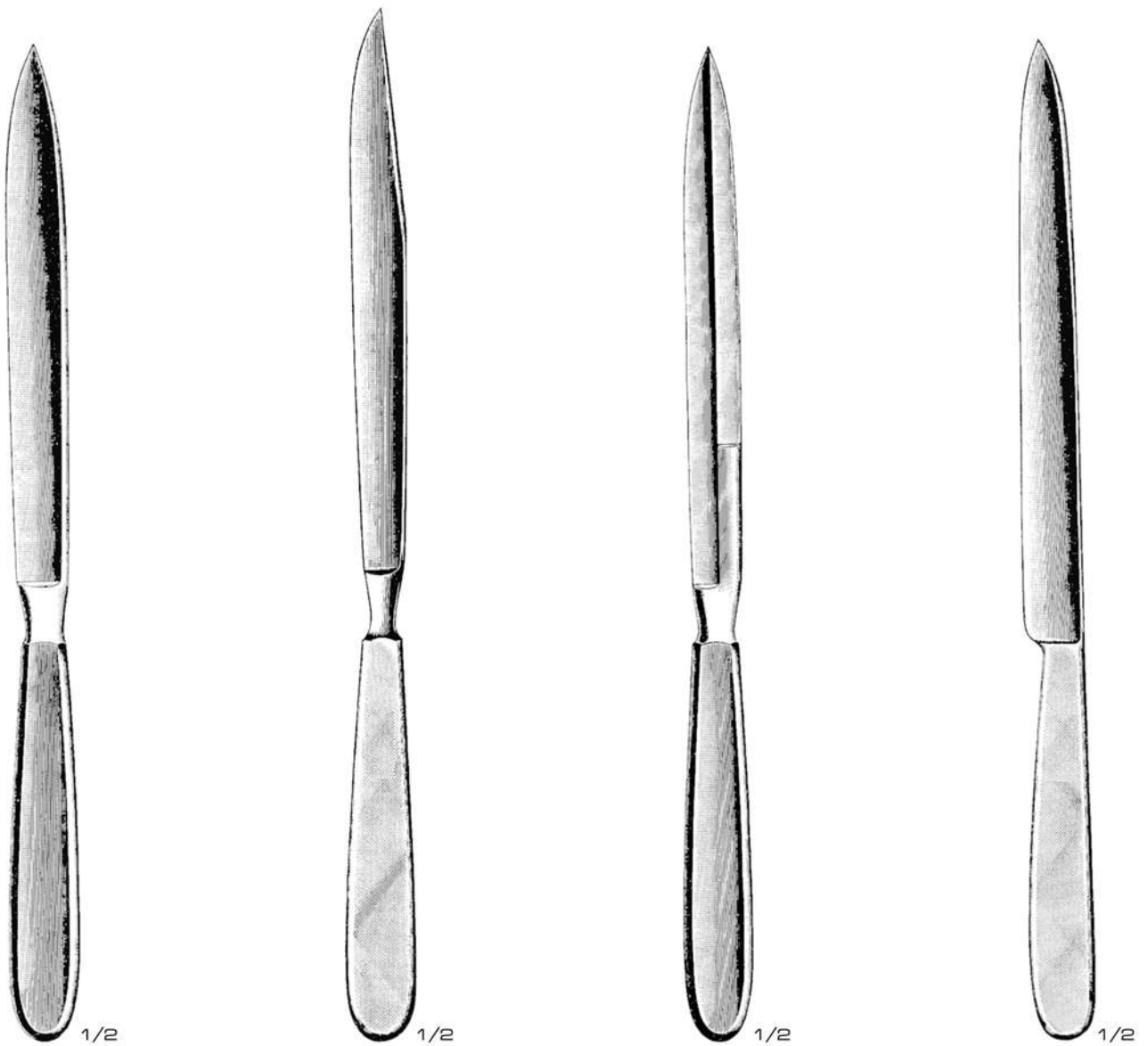

Liston

- 05-2834-12 12 cm / 4³/₄"
- 05-2835-13 13 cm / 5"
- 05-2836-14 14 cm / 5¹/₂"
- 05-2837-15 15 cm / 6"
- 05-2838-16 16 cm / 6¹/₄"
- 05-2839-17 17 cm / 6³/₄"
- 05-2840-18 18 cm / 7"
- 05-2841-20 20 cm / 8"
- 05-2842-22 22 cm / 8³/₄"
- 05-2843-23 23 cm / 9"

Liston

- 05-2844-12 12 cm / 4³/₄"
- 05-2845-13 13 cm / 5"
- 05-2846-14 14 cm / 5¹/₂"
- 05-2847-15 15 cm / 6"
- 05-2848-16 16 cm / 6¹/₄"
- 05-2849-17 17 cm / 6³/₄"
- 05-2850-18 18 cm / 7"
- 05-2851-20 20 cm / 8"
- 05-2852-22 22 cm / 8³/₄"
- 05-2853-23 23 cm / 9"

Collin

- 05-2854-12 12 cm / 4³/₄"
- 05-2855-13 13 cm / 5"
- 05-2856-14 14 cm / 5¹/₂"
- 05-2857-15 15 cm / 6"
- 05-2858-16 16 cm / 6¹/₄"
- 05-2859-17 17 cm / 6³/₄"
- 05-2860-18 18 cm / 7"
- 05-2861-20 20 cm / 8"
- 05-2862-22 22 cm / 8³/₄"
- 05-2863-23 23 cm / 9"

Collin

- 05-2864-12 12 cm / 4³/₄"
- 05-2865-13 13 cm / 5"
- 05-2866-14 14 cm / 5¹/₂"
- 05-2867-15 15 cm / 6"
- 05-2868-16 16 cm / 6¹/₄"
- 05-2869-17 17 cm / 6³/₄"
- 05-2870-18 18 cm / 7"
- 05-2871-20 20 cm / 8"
- 05-2872-22 22 cm / 8³/₄"
- 05-2873-23 23 cm / 9"



Schink
05-2874-30
30 cm / 12"

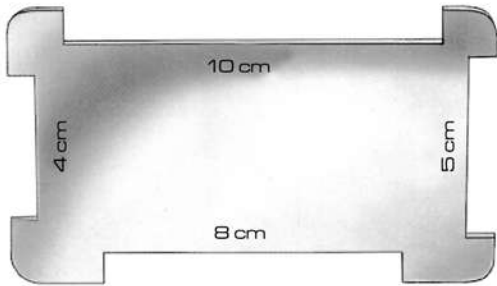

05-2875-00
skin straightening plate



05-2876-10
10 cm / 4"

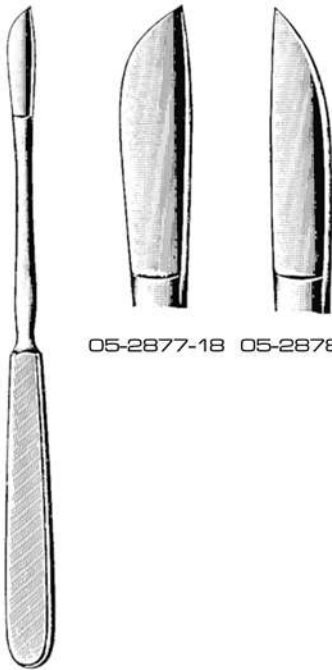

05-2877-18 05-2878-18

Simon
18 cm / 7"



Collin Blade Size
05-2879-12 12 cm / 4³/₄"
05-2880-15 15 cm / 6"
05-2881-17 17 cm / 6³/₄"



Langenbeck Blade Size
05-2882-13 13 cm / 5 ¹/₈"
05-2883-15 15 cm / 6"
05-2884-18 18 cm / 7"
05-2885-20 20 cm / 8"

Sterilization



OGE
ORTHOGENT
ENGINEERING



Rogge
05-2886-23
23 cm / 9"



Cheattle
05-2887-27
27 cm / 10³/₄"

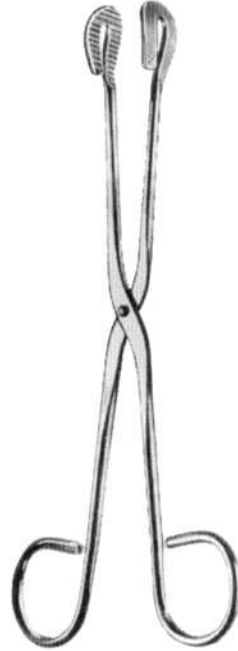

Universal
05-2888-20 20 cm / 8"
05-2889-28 28 cm / 11"



Universal
05-2890-20 20 cm / 8"
05-2891-28 28 cm / 11"



Ulival
05-2892-24
24 cm / 9¹/₂"

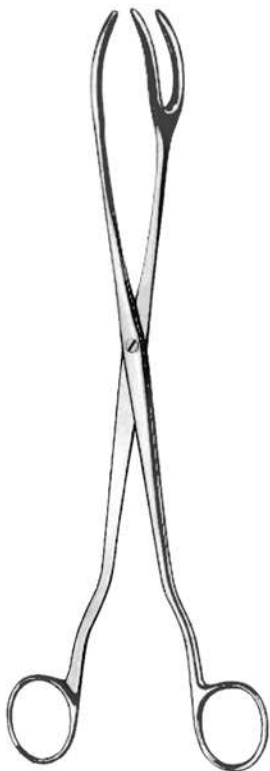

05-2893-20 20 cm / 8"
05-2894-25 25 cm / 10"
05-2895-30 30 cm / 12"

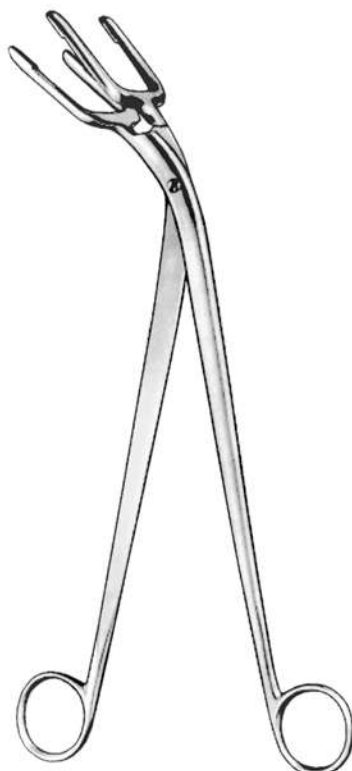

Pye-Smith-Harrison
05-2896-25 25 cm / 10"
05-2897-30 30 cm / 12"
05-2898-35 35 cm / 14"
05-2899-40 40 cm / 16"
05-2900-45 45 cm / 18"



05-2901-24
24 cm / 9¹/₂"



Mayo
05-2902-14
14 cm / 5¹/₂"

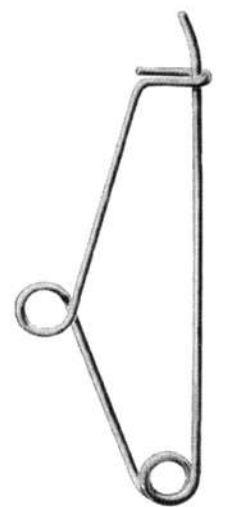

Mayo
05-2903-14
14 cm / 5¹/₂"

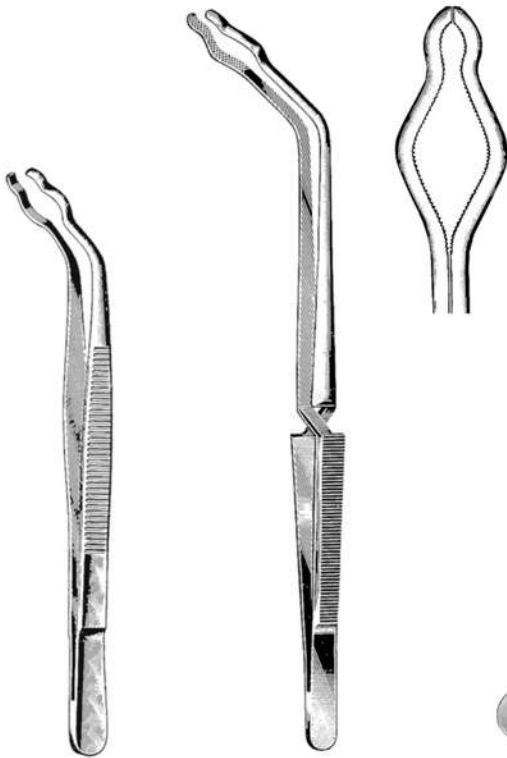

Davis
05-2904-16
16 cm / 6¼"

05-2905-20
20 cm / 8"

05-2906-24
24 cm / 9½"

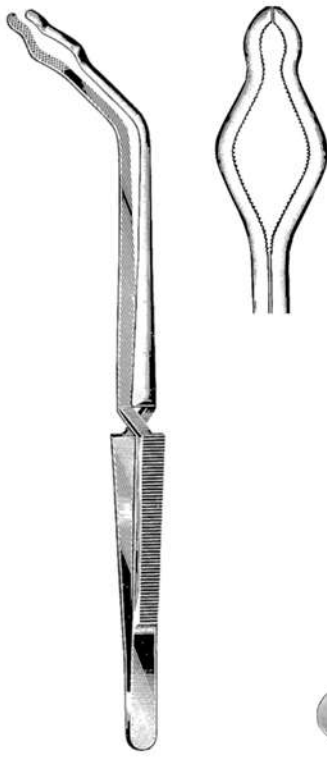

05-2907-18
18 cm / 7"

05-2908-25
25 cm / 10"

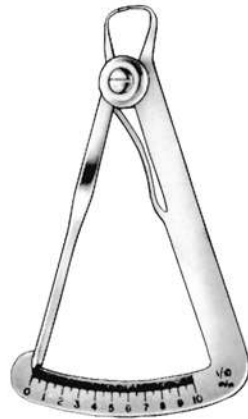

Iwanson
05-2909-12
12 cm / 4¾"
Decimal spring caliper
Measuring Capacity
0-10 mm



05-2910-16
16 cm / 6¼"
Decimal spring caliper
Measuring Capacity
0-15 mm

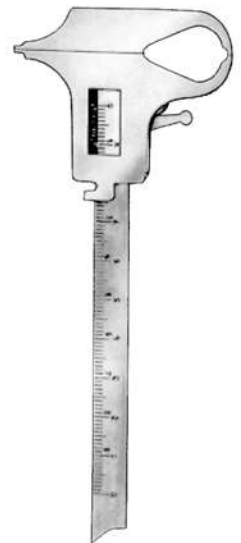

Boley
05-2911-14
14 cm / 5½"
Sliding Caliper
Measuring Capacity
0-100 mm



Ulrich
05-2912-6
6 cm / 2¼"



Ulrich
05-2913-6
6 cm / 2¼"



Simplex
05-2914-12
12 mm



Hoffman
05-2915-13 13 mm
05-2916-17 17 mm
05-2917-20 20 mm
05-2918-25 25 mm
05-2919-30 30 mm
05-2920-40 40 mm
05-2921-50 50 mm



Mohr
05-2922-50 50 mm
05-2923-60 60 mm
05-2924-70 70 mm
05-2925-80 80 mm



Sell
05-2926-80
80 mm

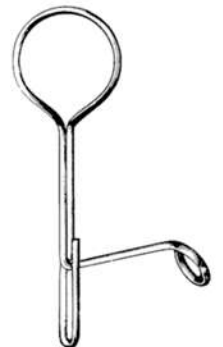

Holt
05-2927-70
70 mm



05-2928-00
205 X 120 X 13 mm
Perforated lid and bottom



05-2929-00
150 X 95 X 13 mm
Non-Perforated lid and bottom



05-2930-00
150 X 95 X 13 mm
Perforated lid and bottom



05-2931-00
150 X 95 X 13 mm
Non-Perforated lid and Perforated bottom



05-2932-00
150 X 95 X 13 mm
Perforated lid and bottom



05-2933-00
150 X 95 X 13 mm
Non-Perforated lid and bottom without rack



05-2934-00
150 X 95 X 13 mm
Perforated lid and bottom without rack

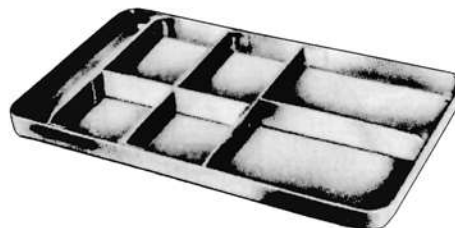

05-2935-00
150 X 95 X 13 mm
Non- Perforated bottom rack only

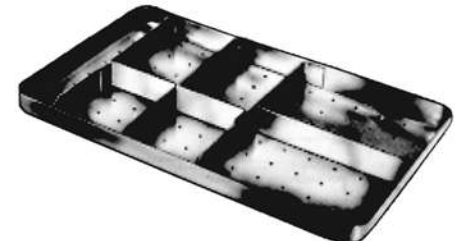

05-2936-00
150 X 95 X 13 mm
Perforated bottom rack only



05-2937-00
135 x 100 x 25 mm

05-2938-00 200 x 100 x 25 mm
05-2939-00 230 x 130 x 25 mm
05-2940-00 275 x 230 x 25 mm
Micro instrument tray with silicone mat, without instruments



STERILIZING CASES, JARS AND STERILE DEPOSIT SYSTEMS



05-2941-25
Sterilizing forceps consisting of:
1 Sterilizing Forceps; 25cm, Cur
without ratchet, with lid for jar
1 Jar with wide bottom plate (anti tilt)

05-2942-32
complete with 32 cm
long Sterilizing forceps.



05-2943-00
Storing Cup for
micro instruments
with silicon bottom plate



05-2944-00 240 x 240 x 50 mm
05-2945-00 240 x 240 x 80 mm
05-2946-00 240 x 240 x 100 mm
05-2947-00 480 x 260 x 50 mm
05-2948-00 520 x 260 x 80 mm
05-2949-00 520 x 260 x 100 mm



Containers L B H Set of special
filters (5 pairs)

- 05-2950-00 230 x 130 x 50 05-2966-00
- 05-2951-00 260 x 150 x 50 05-2967-00
- 05-2952-00 275 x 235 x 50 05-2968-00
- 05-2953-00 300 x 200 x 50 05-2969-00
- 05-2954-00 325 x 275 x 50 05-2970-00
- 05-2955-00 400 x 200 x 50 05-2971-00
- 05-2956-00 420 x 175 x 50 05-2972-00
- 05-2957-00 500 x 200 x 50 05-2973-00
- 05-2958-00 230 x 130 x 75 05-2974-00
- 05-2959-00 260 x 150 x 75 05-2975-00
- 05-2960-00 275 x 235 x 75 05-2976-00
- 05-2961-00 300 x 200 x 75 05-2977-00
- 05-2962-00 325 x 275 x 75 05-2978-00
- 05-2963-00 400 x 200 x 75 05-2979-00
- 05-2964-00 420 x 175 x 75 05-2980-00
- 05-2965-00 500 x 200 x 75 05-2981-00



Ø H
05-2982-00 135 x 40
Lid with knob
05-2983-00 135 x 40
Lid Without knob

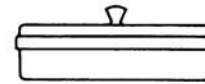

Ø H
05-2984-00 135 x 40
Lid with knob
05-2985-00 135 x 40
Lid Without knob



05-2986-00 200 x 100 x 40
Lid with knob
05-2987-00 200 x 100 x 40
Lid with knob



05-2988-00 200 x 100 x 40
Lid with knob
05-2989-00 200 x 100 x 40
Lid without knob / Perforated lid

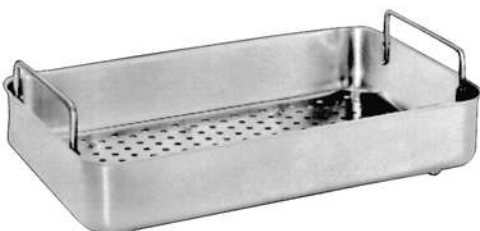

Perforated L B H Non-Perforated
Bottom Bottom
05-2990-00 195 x 95 x 35 05-2996-00
05-2991-00 225 x 125 x 40 05-2997-00
05-2992-00 255 x 145 x 40 05-2998-00
05-2993-00 295 x 195 x 40 05-2999-00
05-2994-00 320 x 270 x 40 05-3000-00
05-2995-00 415 x 170 x 40 05-3001-00



05-3002-00 205 x 105 x 40 mm
05-3003-00 245 x 135 x 35 mm
05-3004-00 245 x 135 x 50 mm
05-3005-00 245 x 135 x 60 mm
Perforated bottom



With lid	Without lid	Lid only	Lid onlt with triangle hole	Ø	H
05-3006-00	05-3015-00	05-3024-00	05-3033-00	30 x 90 mm	
05-3007-00	05-3016-00	05-3025-00	05-3034-00	50 x 100 mm	
05-3008-00	05-3017-00	05-3026-00	05-3035-00	50 x 130 mm	
05-3009-00	05-3018-00	05-3027-00	05-3036-00	50 x 175 mm	
05-3010-00	05-3019-00	05-3028-00	05-3037-00	75 x 100 mm	
05-3011-00	05-3020-00	05-3029-00	05-3038-00	75 x 130 mm	
05-3012-00	05-3021-00	05-3030-00	05-3039-00	75 x 175 mm	
05-3013-00	05-3022-00	05-3031-00	05-3040-00	100 x 175 mm	
05-3014-00	05-3023-00	05-3032-00	05-3041-00	100 x 200 mm	

05-3042-00
With Rack
05-3043-00
Without rack
Ø 125 x (H) 310 mm

05-3044-00
With Rack
05-3045-00
Without rack
Ø 120 x (H) 250 mm

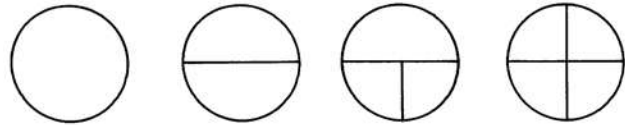

Ø	H				
140 x 140 mm	05-3046-00	05-3060-00	05-3074-29	05-3088-00	
160 x 150 mm	05-3047-00	05-3061-00	05-3075-30	05-3089-00	
190 x 160 mm	05-3048-00	05-3062-00	05-3076-31	05-3090-00	
190 x 190 mm	05-3049-00	05-3063-00	05-3077-32	05-3091-00	
240 x 120 mm	05-3050-00	05-3064-00	05-3078-33	05-3092-00	
240 x 160 mm	05-3051-00	05-3065-00	05-3079-34	05-3093-00	
240 x 240 mm	05-3052-00	05-3066-00	05-3080-35	05-3094-00	
290 x 160 mm	05-3053-00	05-3067-00	05-3081-36	05-3095-00	
290 x 240 mm	05-3054-00	05-3068-00	05-3082-37	05-3096-00	
340 x 160 mm	05-3055-00	05-3069-00	05-3083-38	05-3097-00	
340 x 240 mm	05-3056-00	05-3070-00	05-3084-39	05-3098-00	
390 x 140 mm	05-3057-00	05-3071-00	05-3085-40	05-3099-00	
390 x 190 mm	05-3058-00	05-3072-00	05-3086-41	05-3100-00	
390 x 290 mm	05-3059-00	05-3073-00	05-3087-42	05-3101-00	

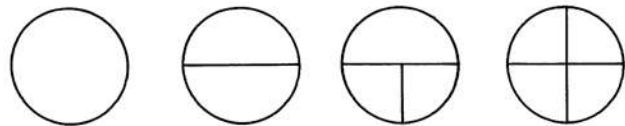

Ø	H				
140 x 140 mm	05-3102-00	05-3116-00	05-3130-29	05-3144-00	
160 x 150 mm	05-3103-00	05-3117-00	05-3131-30	05-3145-00	
190 x 160 mm	05-3104-00	05-3118-00	05-3132-31	05-3146-00	
190 x 190 mm	05-3105-00	05-3119-00	05-3133-32	05-3147-00	
240 x 120 mm	05-3106-00	05-3120-00	05-3134-33	05-3148-00	
240 x 160 mm	05-3107-00	05-3121-00	05-3135-34	05-3149-00	
240 x 240 mm	05-3108-00	05-3122-00	05-3136-35	05-3150-00	
290 x 160 mm	05-3109-00	05-3123-00	05-3137-36	05-3151-00	
290 x 240 mm	05-3110-00	05-3124-00	05-3138-37	05-3152-00	
340 x 160 mm	05-3111-00	05-3125-00	05-3139-38	05-3153-00	
340 x 240 mm	05-3112-00	05-3126-00	05-3140-39	05-3154-00	
390 x 140 mm	05-3113-00	05-3127-00	05-3141-40	05-3155-00	
390 x 190 mm	05-3114-00	05-3128-00	05-3142-41	05-3156-00	
390 x 290 mm	05-3115-00	05-3129-00	05-3143-42	05-3157-00	

PALLETS, IRRIGATORS, GRADUATED MEASURES, MEDICINE CUPS,
SPOON, TABLET TRAY AND PETRI DISHES



Lid With knob Lid without knob Ø H

- 05-3158-00 05-3176-00 30 x 80 mm
- 05-3159-00 05-3177-00 75 x 75 mm
- 05-3160-00 05-3178-00 75 x 80 mm
- 05-3161-00 05-3179-00 100 x 100 mm
- 05-3162-00 05-3180-00 100 x 80 mm
- 05-3163-00 05-3181-00 125 x 125 mm
- 05-3164-00 05-3182-00 125 x 20 mm
- 05-3165-00 05-3183-00 135 x 35 mm
- 05-3166-00 05-3184-00 135 x 50 mm
- 05-3167-00 05-3185-00 135 x 100 mm
- 05-3168-00 05-3186-00 135 x 150 mm
- 05-3169-00 05-3187-00 150 x 100 mm
- 05-3170-00 05-3188-00 150 x 150 mm
- 05-3171-00 05-3189-00 200 x 200 mm
- 05-3172-00 05-3190-00 200 x 160 mm
- 05-3173-00 05-3191-00 240 x 230 mm
- 05-3174-00 05-3192-00 240 x 160 mm
- 05-3175-00 05-3193-00 290 x 240 mm



Capacity in ltrs.

- 05-3194-00 1.0
- 05-3195-00 1.5
- 05-3196-00 2.0

Capacity in ltrs.

- 05-3197-00 1.0
- 05-3198-00 1.5
- 05-3199-00 2.0

05-3200-00
100 cc

05-3201-00 0.25 ltr:
05-3202-00 0.50 ltr:
05-3203-00 1.00 ltr:
05-3204-00 2.00 ltr:



05-3205-25
25 cc



05-3206-50
50 cc



05-3207-20
20 cc



05-3208-00
Ø 75 x 12 mm



05-3209-00 100 x 20 mm
With Lid



05-3210-00 96 x 20 mm
05-3211-00 100 x 20 mm
05-3212-00 100 x 16 mm
With lid



Ø H Cap.
05-3213-00 110 x 27 mm 0.20 ltr
05-3214-00 110 x 40 mm 0.30 ltr



Ø	H	Cap.
05-3215-00	160 x 60 mm	0.75 ltr
05-3216-00	170 x 70 mm	1.00 ltr
05-3217-00	220 x 80 mm	2.00 ltr
05-3218-00	225 x 90 mm	2.50 ltr
05-3219-00	240 x 110 mm	3.00 ltr
05-3220-00	255 x 115 mm	4.00 ltr
05-3221-00	275 x 115 mm	4.50 ltr
05-3222-00	290 x 125 mm	6.00 ltr
05-3223-00	310 x 120 mm	6.00 ltr
05-3224-00	245 x 125 mm	8.50 ltr
05-3225-00	380 x 130 mm	11.00 ltr
05-3226-00	415 x 140 mm	14.00 ltr



Ø	H
05-3227-00	330 x 90 mm
05-3228-00	330 x 115 mm



Ø	H	Cap.
05-3229-00	116 x 35 mm	0.30 ltr
05-3230-00	128 x 38 mm	0.40 ltr
05-3231-00	147 x 40 mm	0.50 ltr
05-3232-00	157 x 45 mm	0.75 ltr
05-3233-00	187 x 45 mm	1.00 ltr



05-3241-00
Ø 110 x 28 mm



Ø	H	Cap.
05-3234-00	40 x 19 mm	0.05 ltr
05-3235-00	61 x 30 mm	0.07 ltr
05-3236-00	116 x 50 mm	0.35 ltr
05-3237-00	128 x 55 mm	0.45 ltr
05-3238-00	147 x 65 mm	0.70 ltr
05-3239-00	168 x 75 mm	1.10 ltr
05-3240-00	187 x 85 mm	1.60 ltr



L	B	H
05-3242-00	230 x 155	30 mm
05-3243-00	235 x 190	40 mm
05-3244-00	300 x 175	30 mm
05-3245-00	300 x 175	40 mm
05-3246-00	330 x 230	30 mm
05-3247-00	330 x 230	50 mm
05-3248-00	350 x 250	30 mm
05-3249-00	350 x 250	50 mm
05-3250-00	400 x 300	50 mm

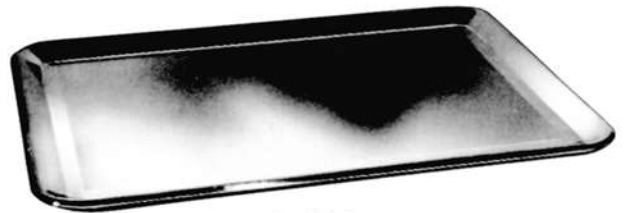

L	B	H
05-3251-00	210 x 160	10 mm
05-3252-00	240 x 180	10 mm
05-3253-00	310 x 150	10 mm
05-3254-00	310 x 210	10 mm
05-3255-00	350 x 240	10 mm
05-3256-00	400 x 270	20 mm
05-3257-00	420 x 280	10 mm



L	B	H
05-3258-00	55 x 29	6 mm
05-3259-00	75 x 29	6 mm
05-3260-00	90 x 37	6 mm



L	B	H
05-3261-00	55 x 29	6 mm
05-3262-00	75 x 29	6 mm
05-3263-00	90 x 37	6 mm

Perforated Bottom



L	B	H
05-3265-00	200 x 150	50 mm
05-3266-00	225 x 150	50 mm
05-3267-00	250 x 200	50 mm
05-3268-00	275 x 175	50 mm
05-3269-00	300 x 200	50 mm
05-3270-00	300 x 250	50 mm
05-3271-00	350 x 250	50 mm
05-3272-00	375 x 300	50 mm
05-3273-00	450 x 300	50 mm

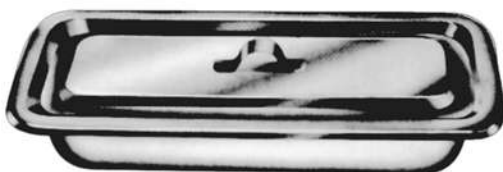

L B H
05-3264-00 200 x 75 x 40 mm

KIDNEY TRAYS, SPUTUM CUP, SPIRIT LAMPS, COTTON AND DRESSING CONTAINER, INSTRUMENTS BOXES AND BUCKET



∅
05-3274-00 150 mm
05-3275-00 200 mm
05-3276-00 250 mm
05-3277-00 300 mm



∅
05-3278-00 150 mm
05-3279-00 200 mm
05-3280-00 250 mm
05-3281-00 300 mm



∅
05-3282-00 150 mm
05-3283-00 200 mm
05-3284-00 250 mm
05-3285-00 300 mm



05-3286-00 100 x 50 mm



05-3287-00 120 ccm



05-3288-00 120 ccm



05-3289-00 120 ccm



05-3290-00 ∅ 50 x 75 mm



∅ H
05-3291-00 80 x 60 mm
05-3292-00 80 x 80 mm
05-3293-00 100 x 60 mm
05-3294-00 100 x 80 mm
05-3295-00 100 x 100 mm
05-3296-00 120 x 80 mm
05-3297-00 120 x 100 mm
05-3298-00 120 x 120 mm
05-3299-00 150 x 100 mm
05-3300-00 150 x 150 mm
05-3301-00 180 x 150 mm
05-3302-00 180 x 180 mm
05-3303-00 200 x 200 mm
05-3304-00 240 x 240 mm



L B H
05-3305-00 150 x 100 x 50 mm
05-3306-00 200 x 100 x 50 mm
05-3307-00 220 x 120 x 50 mm
05-3308-00 240 x 140 x 50 mm
05-3309-00 200 x 150 x 50 mm
05-3310-00 250 x 200 x 50 mm
05-3311-00 300 x 200 x 50 mm
05-3312-00 300 x 250 x 50 mm
05-3313-00 350 x 250 x 50 mm
05-3314-00 400 x 300 x 50 mm
05-3315-00 450 x 300 x 50 mm
05-3316-00 450 x 350 x 50 mm



L B H
05-3317-00 170 x 70 x 35 mm
05-3318-00 180 x 80 x 40 mm
05-3319-00 200 x 100 x 40 mm
05-3320-00 200 x 100 x 50 mm
05-3321-00 200 x 100 x 60 mm
05-3322-00 220 x 120 x 60 mm
05-3323-00 250 x 120 x 60 mm
05-3324-00 300 x 150 x 60 mm
05-3325-00 300 x 200 x 80 mm
05-3326-00 400 x 160 x 80 mm
05-3327-00 400 x 200 x 100 mm
05-3328-00 500 x 200 x 120 mm



05-3329-00 8.0 ltr:
05-3330-00 10.0 ltr:
05-3331-00 12.0 ltr:
05-3332-00 15.0 ltr:



	L	B	H
05-3333-00	170	70	35 mm
05-3334-00	180	80	40 mm
05-3335-00	200	100	40 mm
05-3336-00	200	100	50 mm
05-3337-00	200	100	60 mm
05-3338-00	220	120	60 mm
05-3339-00	250	120	60 mm
05-3340-00	300	150	60 mm
05-3341-00	300	200	80 mm
05-3342-00	400	160	80 mm
05-3343-00	400	200	100 mm
05-3344-00	500	200	120 mm



	L	B	H
05-3345-00	170	70	35 mm
05-3346-00	180	80	40 mm
05-3347-00	200	100	40 mm
05-3348-00	200	100	50 mm
05-3349-00	200	100	60 mm
05-3350-00	220	120	60 mm
05-3351-00	250	120	60 mm
05-3352-00	300	150	60 mm
05-3353-00	300	200	80 mm
05-3354-00	400	160	80 mm
05-3355-00	400	200	100 mm
05-3356-00	500	200	120 mm



05-3357-00



05-3358-00
Male Urinal



05-3359-00
Female Urinal



05-3360-00



05-3361-00



05-3362-00



05-3363-00



Ø 65 mm
05-3364-65



Ø 65 mm
05-3365-65

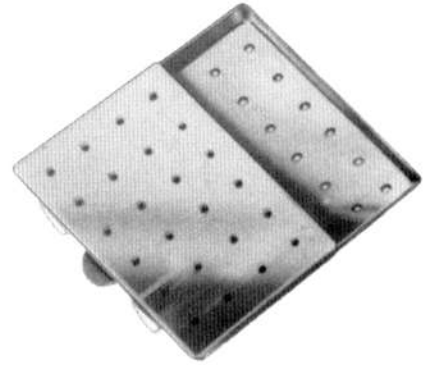

05-3366-50 50 x 25 x 4.5 mm
05-3366-65 65 x 42 x 8.0 mm
05-3367-75 75 x 25 x 4.5 mm

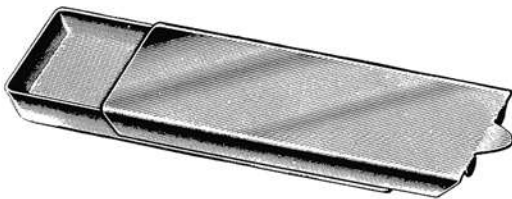

05-3368-50 50 x 25 x 5 mm
05-3369-65 65 x 42 x 8 mm
05-3370-75 75 x 25 x 5 mm
Non-Perforated lid and bottom



05-3371-100 Ø 100 mm
05-3372-120 Ø 120 mm
05-3373-150 Ø 150 mm



Lid with knob	Lid without knob	Lid with handle	Lid with flat handle	L	B	H
05-3374-00	05-3386-00	05-3398-00	05-3410-00	170	70	35 mm
05-3375-00	05-3387-00	05-3399-00	05-3411-00	180	80	40 mm
05-3376-00	05-3388-00	05-3400-00	05-3412-00	200	100	40 mm
05-3377-00	05-3389-00	05-3401-00	05-3413-00	200	100	50 mm
05-3378-00	05-3390-00	05-3402-00	05-3414-00	200	100	60 mm
05-3379-00	05-3391-00	05-3403-00	05-3415-00	220	120	60 mm
05-3380-00	05-3392-00	05-3404-00	05-3416-00	250	120	60 mm
05-3381-00	05-3393-00	05-3405-00	05-3417-00	300	150	60 mm
05-3382-00	05-3394-00	05-3406-00	05-3418-00	300	200	80 mm
05-3383-00	05-3395-00	05-3407-00	05-3419-00	400	160	80 mm
05-3384-00	05-3396-00	05-3408-00	05-3420-00	400	200	100 mm
05-3385-00	05-3397-00	05-3409-00	05-3421-00	500	200	120 mm

Index



A

Abadie.....79
 Adlerkreutz.....33
 Adson.....25, 32, 33, 65, 129
 Adson-Brown.....25, 32
 Adson-Graefe.....33
 Alexander.....168
 Allen.....78
 Allis-Adair.....75
 Allis-Atrauma.....75
 Allis-Baby.....75
 Amputation Knives.....190 - 192
 Anal Retractors.....155
 Anatomy Knives.....187 - 189
 Ankeney.....147
 Anoscopes, Sphincteroscopes.....156
 Arruga.....46, 121, 124
 Atrauma Intestinal Forceps.....81, 82, 84
 Atrauma Sigmoid Anastomosis Forceps.....83, 85, 86
 Atrauma Tissue Forceps.....75
 Atraumatic Tissue Forceps.....35
 Auvard.....162
 Ayre.....187

B

Babcock.....75
 Babcock-Atrauma.....76
 Babcock-Tc.....76
 Baby Payr.....153
 Baby-Adson.....65
 Baby-Crie-Wood.....48
 Baby-Doyen.....76
 Baby-Kocher.....77
 Baby-Lexer.....13
 Baby-Metzenbaum.....9, 12
 Baby-Milkulicz.....74
 Baby-Mixer.....63, 69
 Baby-Overholt.....65
 Baby-Tischler.....170
 Backhaus.....51
 Baer.....139
 Bailey.....108, 109, 150
 Bailey-Baby.....150
 Bainbridge.....69
 Ball & Socket.....51
 Bandage And Cloth Scissors.....21,
 2
 Barr.....155
 Barraquer.....121, 122
 Barraquer-Troutman.....122
 Barrett.....87
 Barry Sternal.....39
 Beacham.....167
 Bed Pans.....203
 Beebee.....19
 Bengolea.....64
 Benson.....79
 Berger.....169
 Bergmann.....21
 Bernhard.....51
 Bethune.....139
 Biopsy And Specimen Forceps.....168 - 172
 Biopsy Curettes.....167
 Birkett.....71
 Blake.....176
 Boettcher.....16
 Boley.....196
 Bonney.....27, 34
 Boynton.....46
 Boys-Allis.....75
 Bozemann.....44, 49, 87, 164
 Bozemann-Douglas.....87
 Brain Knives.....190, 191
 Braun.....88, 167
 Braun-Stadler.....19
 Breisky.....163, 180
 Bridge.....71
 Brinkerhoff.....155
 Brock.....124, 133
 Bronchus Clamps.....70
 Brophy.....13, 29
 Brunner.....77, 138
 Bruns.....8, 22
 Bucket.....202
 Burford.....144
 Busch.....19

C

Castaneda.....147
 Castroviejo.....47, 123, 124, 126, 185
 Castroviejo-Kalt.....121
 Castroviejo-Baraquer.....126
 Chaput.....54, 75
 Cheattle.....195
 Cheron.....53
 Collier.....48, 54, 61
 Collin.....53, 137, 161, 167, 180, 191, 192
 Collin (New Model).....162
 Common Bile Duct Dilators.....158
 Cone Knives.....187
 Contractors.....150
 Converse.....39
 Cook.....154
 Cooley.....112 - 118, 140, 146
 Cooley-Beck.....114
 Coryllos-Bethune (Collin).....139
 Cottle.....16
 Cotton Container.....202
 Crafoord-Sellers.....68
 Crawford.....66
 Crafoord.....150
 Crie-Murray.....48
 Crile.....58
 Crile-Rankin.....57
 Crile-Wood.....39, 40, 48
 Crown.....19
 Cusco.....161
 Cusco (Japanese Model).....161
 Cushing.....25, 26, 29, 31
 Cushing Taylor.....26
 Czemy.....88, 154

D

Dandy.....61
 Dartigues.....90
 Davis.....196
 De Bakey.....17, 26, 35, 40, 41, 95 - 97, 99 - 106, 111, 129, 143
 De Bakey Reynolds.....97
 De Bakey-Bahnsen.....103
 De Bakey-Bainbridge.....102
 De Bakey-Beck.....96, 97, 107
 De Bakey-Crafoord.....107
 De Bakey-Crafoord (Mod.).....107
 De Bakey-Derra.....97
 De Bakey-Glover.....96
 De Bakey-Satinsky.....107
 De Lee.....179, 180
 Dean.....21
 Deaver.....10
 Delicate Surgical Scissors.....15
 Dennis-Browne.....153
 Dental Dressing Forceps.....36
 Derf.....39, 48
 Desjardins.....70, 158
 Dick.....83
 Dieffenbach.....185
 Dietrich.....5
 Dietrich-Hegemann.....17
 Dilating Bougies.....159
 Dissecting Forceps.....28, 67, 68
 Dissecting Scissors.....12 - 14
 Dixon-Lovelace.....63
 Doyen.....18, 48, 76, 82, 163, 167
 Dressing Container.....202
 Dressing Forceps.....28, 29, 31, 33, 36, 52, 53, 90, 153
 Dressing Forceps With TC.....25 - 27
 Duplay.....87
 Duval.....76, 153
 Duval-TC.....76

E

Ear Forceps.....36
 Elevating Forceps.....90
 Emmett.....167
 Endospecula.....160
 Eng. Modell.....52
 Episiotomy Scissors.....19
 Eppendorf.....168 - 170
 Esmarch.....22
 Evans.....26

F

Farrell.....158
 Farrell (Lathbury).....158
 Faure.....73, 74, 172
 Fehland.....85
 Feilchenfeld.....35
 Fergusson.....15
 Ferris-Smith.....27
 Fine.....30
 Fine Surgical Scissors.....14
 Finocchio.....44, 70, 142, 144 - 147
 Finocchio-Baby-Haight.....146
 Foerster.....52, 53
 Fomon.....19
 Funnel.....204

G

Gall Duct Clamps.....70
 Gall Stone Scopes.....158
 Gaylor.....172
 Gemini.....67
 Gerald.....27, 29, 130
 Giertz-Stille.....138
 Gillies.....26, 31, 45
 Gillies-Slim.....45
 Glassman.....84, 86
 Glover.....99, 109, 110
 Glover-Satinsky.....99
 Gluck.....137
 Goldman-Fox.....4, 20
 Gomel.....126, 131
 Good.....16
 Gourdet.....177
 Graduated Measures.....200
 Graefe.....36
 Grave.....160
 Gray.....69
 Brazil.....11
 Green-Armytage.....89
 Gross-Maier.....53
 Gruenwald.....27, 36
 Guyon.....70, 159
 Gynecology Scissors.....18

H

Haemorrhoidal Forceps.....160
 Haemostatic Forceps.....54, 55 - 67, 69, 71
 Haight.....141
 Halsey.....39, 148
 Halstead.....56
 Halstead-Mosquito.....56
 Harken.....108, 109
 Hartmann.....55
 Hayes.....86
 Heaney.....72
 Heaney-Kanter.....72
 Heaney-Rezak.....71
 Hegar.....41, 165, 166
 Hegar-Baumgartner.....39
 Hegar-Vascular.....43
 Heifetz.....128
 Heiss.....59, 63
 Herrick.....70
 Hertzler.....143
 Hirschmann.....156
 Hoffman.....196
 Holt.....196
 Hudson (Ewald).....31
 Hunt.....128
 Hunter.....35
 Hysterectomy Forceps.....71 - 74

I

Instruments Boxes.....202, 204
 Instruments for Mini Laprotomy & for removal of I.U.D.....175
 Instruments Trays.....201
 Intestinal Clamp Forceps.....79
 Intestinal Clamps.....77, 78, 153
 Intracardiac.....43
 Iowa.....90
 Iris.....3, 9, 14, 28
 Irrigators.....200
 Ives-Fansler.....156
 Iwanson.....196



J

Jacobs.....89
 Jacobson.....47, 124, 127, 133
 Jacobson-Adson.....131
 Joll (Friedman).....179
 Jones.....52
 Joseph.....14
 Judd-Allis.....75
 Julian.....41

K

Kahn.....88
 Kalt.....47, 121
 Kalt-Arruga.....121
 Kantrowitz.....67
 Kelly.....4, 18, 57, 90, 156
 Kelly-Rankin.....57
 Kersting.....86
 Kevorkian.....167 - 170
 Kidney Pedicle Clamps.....70
 Kidney Stone Forceps.....159
 Kidney Trays.....202
 Kielland.....179
 Kilner.....40
 Kilner (Ragnell).....13
 Kleinschmidt.....79
 Kocher.....58, 59, 77, 81
 Kocher (Delicate).....63
 Kocher-Ochsner.....62
 Kogan.....160
 Kristeller.....162
 Kroenlein.....54

L

Lahey.....69, 88
 Landolt.....15
 Lane.....33, 51, 77, 80
 Lange.....22
 Langenbeck.....47, 188, 192
 Langenbeck-Ryder.....47
 Lawrence.....69
 Lebsche.....138, 139
 Lees.....111
 Leland-Jones.....102
 Lemmon.....150
 Leriche.....63
 Lexer.....8, 13
 Lichtenberg.....50
 Ligature Scissors.....15, 16
 Lister.....8, 21, 52
 Lister-Excentric.....21
 Liston.....191
 Littauer.....16
 Littler.....15
 Littlewood.....90
 Lockhart-Mummary.....157
 Locklin.....5, 21
 Lockwood-Allis.....76
 London College.....36
 Long.....71
 Lorenz.....22
 Lorna.....51
 Lower.....69
 Lucae.....36
 Luer-Korte.....158

M

Maingot.....72
 Martel.....54
 Masson.....44
 Mathieu.....46, 50, 154
 Mathieu-Kersten.....50
 Mathieu-Kocher.....46, 50
 Mathieu-Slim.....46
 Mathieu-Sverige.....50
 Mayo.....7, 11, 195
 Mayo-Hegar.....41, 48
 Mayo-Hegar (Heaney).....42
 Mayo-Hegar-Delicate.....49
 Mayo-Noble.....12

Mayo-Robson.....76, 84
 Mayo-Russian.....34
 Mayo-Stille.....7, 12
 Mc Givney.....160
 Mc Indoe.....16, 26, 29
 Measuring Jars.....199
 Medicine Cups.....200
 Medicine Spoon.....200
 Medina.....172
 Meeker.....69
 Meriam.....36
 Metzenbaum.....7, 12, 13
 Metzenbaum-Fino.....6, 7, 8, 12, 13
 Metzenbaum-Nelson.....9
 Metzenbaum-S.....5
 Metzenbaum-Thorek.....5
 Metzembum-Mathieu.....46
 Micro Forceps.....130 - 133
 Micro Needle Holders.....121 - 127
 Micro-Adson.....32
 Micro-Adson Biemer.....33
 Micro-Mosquito.....56
 Micro-Slim.....43
 Milkulicz.....74, 78
 Mini Thoracotomy.....148
 Mini-Townsend.....170
 Mixer.....13, 69
 Mixer-O'Shaugnessy.....70
 Mod. Bonn.....15
 Mod. U.S.A.....19, 28, 30
 Mohr.....196
 Morse.....140
 Moynihan.....72
 Muller.....124
 Museux.....88, 89
 Myoma Instruments.....167

N

Naegele.....179
 Nail And Gum Scissors.....20, 21
 Narrow.....30
 Nasal Scissors.....16
 Naunton-Morgan.....45
 Needle Holders.....48 - 50
 Needle Holders With Tungsten Carbide Inserts.....39 - 47
 Needles Sterilizing Cases.....204
 Negus.....70
 Nelson.....34
 New Orleans.....40
 Nivert.....40
 Non-Traumatic Bulldog Clamps.....98, 99
 Non-Traumatic Vascular Clamps.....93 - 97, 100 - 118
 Northbent.....16
 Novak.....167
 Noyes.....122

O

Obstetric Pelvimeters.....180
 Obstetrical Forceps And Retractor.....179
 Obstetrics Placenta Forceps.....178
 Oehler.....25
 Olsen-Hegar.....45, 49
 Operating Scalpels.....186
 Organ Grasping Forceps.....75
 Organ Holding Forceps.....76, 77
 Overholt.....65
 Overholt-Geiddendoerfer.....66
 Ovum Forceps.....178

P

Pallats.....200
 Parametrium.....6
 Park.....154
 Paton.....123
 Payr.....153
 Pean.....59
 Pean Delicate.....58
 Pederson.....160
 Peers.....51
 Peet.....35
 Penis Clamps.....159
 Pennington.....54
 Peritonium Forceps.....73, 74
 Perry.....36

Petri Dishes.....200
 Phaneuf.....73
 Piper.....179
 Plaster Of Paris Shears.....22
 Post Mortem Knives.....187 - 192
 Potts-Smith.....4, 17, 26, 28, 31, 121
 Pratt.....89, 154, 166
 Presbyterian.....55
 Probes.....157, 158
 Providence-Hospital.....57
 Pye-Smith-Harrison.....195

Q

Quervain.....148
 Quinby.....20

R

Ragnell (Kilner).....4
 Ramathibodi.....175
 Rampley.....52
 Ramsay.....31
 Randall.....159, 167
 Razor Blade Breakers And Removers.....185
 Razor Blade Holders.....185
 Recamer.....173
 Rectal Specula.....154
 Rehbein (Mod. Bremon).....150
 Reill.....124
 Reinhold-Finocchio.....143
 Resano.....85
 Retractor.....179
 Reynolds.....14
 Rib Shears.....137 - 139
 Rib Spreaders.....140 - 150
 Roberts.....66
 Rochester-Carmalt.....61
 Rochester-Pean.....60
 Roeder.....51
 Rogge.....195
 Rohrschneider.....123
 Round Bowls.....201
 Rumel.....67, 111
 Russ. Modell.....33
 Ryder.....42
 Ryder-Vascular.....42

S

Saenger.....89
 Safety Pins.....196
 Samii.....129
 Sarot.....44, 68
 Sauerbruch.....138
 Sauerbruch-Frey.....138
 Sauerbrush-Britsch.....139
 Saunders.....175
 Scalpel Handles.....183, 184
 Scheadel.....52
 Scherbeck.....164
 Schindler.....74
 Schridt.....59
 Schroeder.....87, 88, 177
 Schubert.....171
 Schuchardt.....138
 Schudder.....80, 82
 Schumacher.....139, 168, 169
 Schumacher-Van-Doren.....171
 Scissors.....1 - 22
 Segond.....187
 Select.....31
 Sell.....196
 Sellors.....150
 Semken.....27, 28, 31
 Sengond-Landau.....73
 Seutin.....22
 Shortbent.....16
 Sich Children Hospital Toronto.....141
 Simon.....176, 192
 Simplex.....196
 Simpson.....179
 Simpson-Braun.....179
 Sims.....6, 18, 154, 163, 167, 174
 Sims-Maier.....90
 Singley-Tuttle.....34

Skene.....68
 Skin Grafting Knife And Amputation Knives.....192
 Skinner.....27
 Smith (Mod. Usa).....22
 Smith-Buie.....155
 Solution Bowls.....201
 Somer.....90
 Special Forceps.....128, 129
 Spencer.....15
 Spencer-Delicate.....15
 Spencer-Wells.....61
 Spirit Lamps.....202
 Splinter Forceps.....35
 Sponge Forceps.....52, 53
 Sputum Cup.....202
 Standard.....3, 9, 10, 25, 28, 30
 Standard - Fine.....30
 Standard - Narrow.....30
 Sterile Deposit Systems.....198
 Sterilizing Boxes.....203
 Sterilizing Cases.....196, 198
 Sterilizing Drums.....199
 Sterilizing Forceps.....195, 196
 Sterilizing Jars.....198
 Sterilizing Tools.....196
 Stevens.....15, 121
 Stieglitz.....35
 Stille.....28, 31, 70, 137
 Stille-Barraya.....153
 Stockmann.....159
 Stomach Clamp Forceps.....79 - 82, 153
 Storing Cases.....196
 Strabismus.....9, 14
 Strate.....43, 49
 Strauss.....159
 Struck.....141
 Sullivan.....20
 Supercut Scissors.....9
 Surgical Scissors.....10, 11
 Surgical Scissors With TC Inserts.....3 - 8

T

Tablet Tray.....200
 Tarnier.....179
 Taylor.....29, 32
 Teale.....89
 Tenaculum Forceps.....87
 Terrier.....55
 Thole.....180
 Thomas.....176
 Thoms-Allis.....75
 Thoms-Gaylor.....172
 Thoracic Retractor (Mercedes Retractor).....149
 Thumb Forceps.....23 - 36
 Tischler.....170, 172
 Tischler-Kevorkian.....170
 Tischler-Morgan.....170
 Tissue Forceps.....29 - 36, 76
 Tissue Forceps With TC Inserts.....25 - 27
 Tissue Grasping Forceps.....54, 75
 Toennis.....47, 67
 Tohoku.....51
 Tonsil Scissors.....15
 Towel Clamps.....51, 52
 Troeltsch.....36
 Troutman Chris.....185
 Tubing Clamps.....55
 Tuffier.....54, 142

U

Ulleval.....195
 Ulrich.....53, 196
 Umbilical Cord Scissors.....19
 Universal.....5, 19, 22, 195
 Urinals.....203
 Uterine Curettes.....173, 174, 176
 Uterine Dilators.....165, 166
 Uterine Dressing Forceps.....87
 Uterine Probes.....167
 Uterine Scoops.....177
 Uterine Teneculum Forceps.....87 - 90

V

Vaginal Specula.....160 - 164
 Van Buren.....159
 Van-Doren.....171
 Vascular Scissors.....16, 17
 Veidenheimer.....85
 Virchow.....187

W

Wagner.....14
 Walbb.....190
 Waldmann.....19
 Wangenstein.....27, 44, 49, 153
 Wash Basins.....201
 Watchmakers Forceps.....34
 Weber.....105
 Webster.....39, 48
 Werheim.....18, 43, 71
 Werheim-Cullen.....73
 Werheim-De-Bakey.....73
 Westcott.....9
 Wikstroem.....71
 Willet-Martel.....54
 Williams.....26, 75
 Winter.....178
 Wire And Crown Scissors.....19
 Wrigley.....179
 Wylie.....104, 165

Y

Yasargil.....127, 128, 130, 133
 Yasargil-Samii.....129

Z

Zaufel (Blake).....176
 Zenker.....68
 Zwifel.....47

OGE